

TEST REPORT

Applicant:

Address:

The following sample(s) was/were submitted and identified on behalf of the client as:

Product name: Lithium-ion Rechargeable Cell

Test model: BTW INR 18650-25EC

Serial model: BTW INR 18650-26EC, BTW INR 18650-25PC, BTW INR 18650-32EC,
BTW INR 18650-26B, BTW INR 18650-25FC, BTW INR 18650-20PC,
BTW INR 21700-40PC, BTW INR 21700-45EC, BTW INR 21700-50EC,
BTW INR 21700-40EC, BTW INR 21700-48B, BTW INR 21700-40HC,
BTW INR 21700-42EC

Manufacturer&

Factory:

Address:

Sample Received

Date: Dec. 23, 2022

Testing Period: Dec. 23, 2022~Jan. 05, 2023

Test Requirement:

As specified by client, to test Lead(Pb), Cadmium(Cd), Mercury(Hg) in the submitted sample(s) in accordance with battery directive 2006/66/EC and amendment 2013/56/EU.

Test Result(s): Please refer to the following page(s);

Test Method: Please refer to the following page(s);

Compiled by: _____

*Pure
May*

Reviewed by: _____

Y. Blom

Approved by: _____

Date: _____

2023-02-23

Test Result(s):

Test item(s)	Limit, mg/kg	Result(s), mg/kg
Lead (Pb)	40*	N.D.
Cadmium (Cd)	20	N.D.
Mercury (Hg)	5	N.D.
Conclusion	/	Pass

Sample Description:

Battery

Note: 1mg/kg = 1ppm = 0.0001%
N.D. = Not Detected (<MDL)
MDL = Method Detection Limit
/=Not Regulated or Not Applicable

Remark: 1. According to EU Directive 2006/66/EC and amendment 2013/56/EU
(1) Without prejudice to directive 2000/53/EC, Member States shall prohibit the placing on the market of:
(a) all batteries or accumulators, whether or not incorporated into appliances, that contain more than 0.0005% (5mg/kg)of mercury by weight;
(b) portable batteries or accumulators, including those incorporated into appliances, that contain more than 0.002% (20mg/kg)of cadmium by weight.
(2) The prohibition set out in paragraph (1) (b) shall not apply to portable batteries and accumulators intended for use in:
(a) emergency and alarm systems, including emergency lighting; or
(b) medical equipment.
(3) *Batteries, accumulators and button cells containing more than 0.004%(40mg/kg) of lead, shall be marked with the chemical symbol for the metal concerned: Pb.

2. Results shown are of total weight of the battery sample.

3. The test results in this report are only responsible for the tested samples. According to the client's statement, series models are the same material as the test models. The series model samples provided by customers have not been tested in this report.

Test Method:

Testing Item(s)	Test Method	Test instrument	MDL
Lead (Pb)	Refer to IEC 62321-5:2013	ICP-OES	2 mg/kg
Cadmium (Cd)	Refer to IEC 62321-5:2013	ICP-OES	2 mg/kg
Mercury (Hg)	Refer to IEC 62321-4:2013+AMD1:2017	ICP-OES	0.5 mg/kg

Test Flow:

1. Lead (Pb), Cadmium (Cd)

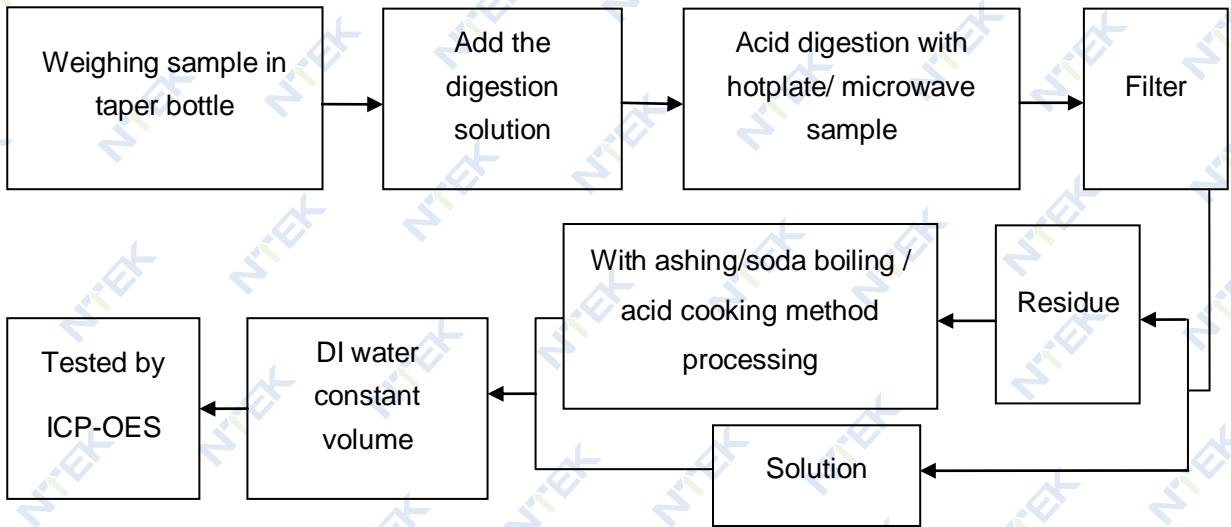

2. Mercury (Hg)

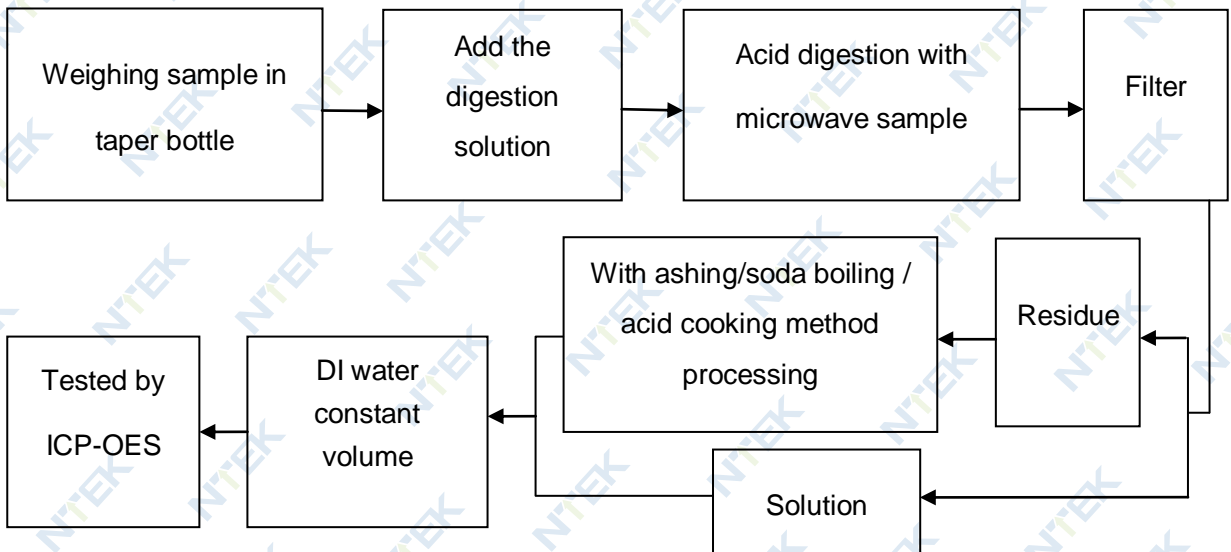

Sample photo(s):



Fig.1

This test report displaces the original report No. S22122302302E, and the original one was invalid since the date of this test report released.

**** End of Report****

The test results or data in this report will be used only for education, scientific research, enterprise product development and internal quality control or other purposes.

The test report is effective only with both signature and specialized stamp, The result(s) shown in this report refer only to the sample(s) tested. Without written approval of NTEK, this report can't be reproduced except in full.



Test Report issued under the responsibility of:



**TEST REPORT
IEC 62133-2**

Secondary cells and batteries containing alkaline or other non-acid electrolytes – Safety requirements for portable sealed secondary cells, and for batteries made from them, for use in portable applications – Part 2: Lithium systems

Report Number..... : CN23QNCN 001

Date of issue..... : 2023-08-03

Total number of pages..... : 39 pages

Name of Testing Laboratory preparing the Report : Shenzhen NCT Testing Technology Co., Ltd

Applicant's name..... :

Address..... :

Test specification:

Standard..... : IEC 62133-2:2017, IEC 62133-2:2017/AMD1:2021

Test procedure..... : CB Scheme

Non-standard test method : N/A

TRF template used : IECEE OD-2020-F1:2021, Ed.1.4

Test Report Form No. : IEC62133_2C

Test Report Form(s) Originator.... : DEKRA Certification B.V.

Master TRF : Dated 2022-07-01

Copyright © 2022 IEC System of Conformity Assessment Schemes for Electrotechnical Equipment and Components (IECEE System). All rights reserved.

This publication may be reproduced in whole or in part for non-commercial purposes as long as the IECEE is acknowledged as copyright owner and source of the material. IECEE takes no responsibility for and will not assume liability for damages resulting from the reader's interpretation of the reproduced material due to its placement and context.



If this Test Report Form is used by non-IECEE members, the IECEE/IEC logo and the reference to the CB Scheme procedure shall be removed.

This report is not valid as a CB Test Report unless signed by an approved IECEE Testing Laboratory and appended to a CB Test Certificate issued by an NCB in accordance with IECEE 02.

General disclaimer:

The test results presented in this report relate only to the object tested.

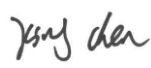
This report shall not be reproduced, except in full, without the written approval of the Issuing NCB. The authenticity of this Test Report and its contents can be verified by contacting the NCB, responsible for this Test Report.

Test item description..... :	Lithium-ion Cell	
Trade Mark(s)..... :	N/A	
Manufacturer..... :	Same as applicant	
Model/Type reference..... :	1). IMR18650T12; 2). IMR18650T16; 3). IMR18650T18; 4). IMR18650L18; 5). INR18650T20; 6). INR18650L20; 7). INR18650T22; 8). INR18650L22; 9). INR18650T25; 10). INR18650L25; 11). INR18650T26; 12). INR18650L26; 13). INR18650L30; 14). INR18650L32	
Ratings..... :	1). 3.7V, 1200mAh; 2). 3.7V, 1600mAh; 3). 3.7V, 1800mAh; 4). 3.7V, 1800mAh; 5). 3.7V, 2000mAh; 6). 3.7V, 2000mAh; 7). 3.7V, 2200mAh; 8). 3.7V, 2200mAh; 9). 3.7V, 2500mAh; 10). 3.7V, 2500mAh; 11). 3.7V, 2600mAh; 12). 3.7V, 2600mAh; 13). 3.7V, 3000mAh; 14). 3.7V, 3200mAh	
Responsible Testing Laboratory (as applicable), testing procedure and testing location(s):		
<input checked="" type="checkbox"/>	CB Testing Laboratory:	Shenzhen NCT Testing Technology Co., Ltd
	Testing location/ address	A101A&2F, B2, Fuqiao 6th Area, Xintian Community, Fuhai Street, Baoan District, Shenzhen, China
	Tested by (name, function, signature)..... :	King Chen (Project Engineer) 
	Approved by (name, function, signature) :	Hely Wang (Reviewer) 
<input type="checkbox"/>	Testing procedure: CTF Stage 1:	
	Testing location/ address	
	Tested by (name, function, signature)..... :	
	Approved by (name, function, signature) :	
<input type="checkbox"/>	Testing procedure: CTF Stage 2:	
	Testing location/ address	
	Tested by (name + signature)	
	Witnessed by (name, function, signature):	
	Approved by (name, function, signature) :	
<input type="checkbox"/>	Testing procedure: CTF Stage 3:	
<input type="checkbox"/>	Testing procedure: CTF Stage 4:	
	Testing location/ address	
	Tested by (name, function, signature)..... :	
	Witnessed by (name, function, signature):	
	Approved by (name, function, signature) :	
	Supervised by (name, function, signature):	

<p>List of Attachments (including a total number of pages in each attachment): Attachment 1: (Republic of Korea) National Differences (4 pages). Attachment 2: Photo documentation (6 pages).</p>	
<p>Summary of testing:</p>	
<p>Tests performed (name of test and test clause): cl.7.1 Charging procedure for test purposes (for Cells); cl.7.2.1 Continuous charging at constant voltage (Cells); cl.7.3.1 External short circuit (Cells); cl.7.3.3 Free fall (Cells); cl.7.3.4 Thermal abuse (Cells); cl.7.3.5 Crush (Cells); cl.7.3.7 Forced discharge (Cells); cl.7.3.9 Design evaluation – Forced internal short-circuit (Cells);</p> <p>Tests are made with the number of cells specified in IEC 62133-2: 2017, IEC 62133-2:2017/AMD1:2021 Table 1.</p>	<p>Testing location: Shenzhen NCT Testing Technology Co., Ltd A101A&2F, B2, Fuqiao 6th Area, Xintian Community, Fuhai Street, Baoan District, Shenzhen, China</p>
<p>Summary of compliance with National Differences (List of countries addressed): KR KR=Korea, Republic of</p> <p><input checked="" type="checkbox"/> The product fulfils the requirements of <u>EN 62133-2:2017, EN 62133-2: 2017/A1:2021</u></p>	

Use of uncertainty of measurement for decisions on conformity (decision rule) :

No decision rule is specified by the IEC standard, when comparing the measurement result with the applicable limit according to the specification in that standard. The decisions on conformity are made without applying the measurement uncertainty ("simple acceptance" decision rule, previously known as "accuracy method").

Other:... (to be specified, for example when required by the standard or client, or if national accreditation requirements apply)

Information on uncertainty of measurement:

The uncertainties of measurement are calculated by the laboratory based on application of criteria given by OD-5014 for test equipment and application of test methods, decision sheets and operational procedures of IECEE.

IEC Guide 115 provides guidance on the application of measurement uncertainty principles and applying the decision rule when reporting test results within IECEE scheme, noting that the reporting of the measurement uncertainty for measurements is not necessary unless required by the test standard or customer.

Calculations leading to the reported values are on file with the NCB and testing laboratory that conducted the testing.

Copy of marking plate:

The artwork below may be only a draft. The use of certification marks on a product must be authorized by the respective NCBs that own these marks.

N/A

Remark:

By agreement between the cell manufacturer and the battery and/or end product manufacturer, component cells used in the manufacture of a battery need not be marked.

Test item particulars.....:	
Classification of installation and use.....:	To be defined in final product
Supply Connection.....:	DC terminal contacts
Recommend charging method declared by the manufacturer.....:	Charging the cell with 0.5C constant current until 4.25V, then constant voltage until the charge current reduces to 0.01C at ambient 20°C±5°C.
Discharge current (0,2 It A).....:	1). IMR18650T12: 240mA; 2). IMR18650T16: 320mA; 3). IMR18650T18: 360mA; 4). IMR18650L18: 360mA; 5). INR18650T20: 400mA; 6). INR18650L20: 400mA; 7). INR18650T22: 440mA; 8). INR18650L22: 440mA; 9). INR18650T25: 500mA; 10). INR18650L25: 500mA; 11). INR18650T26: 520mA; 12). INR18650L26: 520mA; 13). INR18650L30: 600mA; 14). INR18650L32: 640mA
Specified final voltage.....:	2.5V
Upper limit charging voltage per cell.....:	4.25V
Maximum charging current.....:	1C
Charging temperature upper limit.....:	45°C
Charging temperature lower limit.....:	0°C
Polymer cell electrolyte type.....:	<input type="checkbox"/> gel polymer <input type="checkbox"/> solid polymer <input checked="" type="checkbox"/> N/A
Possible test case verdicts:	
- test case does not apply to the test object..... : N/A	
- test object does meet the requirement..... : P (Pass)	
- test object does not meet the requirement..... : F (Fail)	
Testing..... :	
Date of receipt of test item..... :	2023-07-03
Date (s) of performance of tests..... :	2023-07-03 to 2023-07-22
General remarks:	
"(See Enclosure #)" refers to additional information appended to the report. "(See appended table)" refers to a table appended to the report.	
Throughout this report a <input type="checkbox"/> comma / <input checked="" type="checkbox"/> point is used as the decimal separator.	
Manufacturer's Declaration per sub-clause 4.2.5 of IEC62 02:	

The application for obtaining a CB Test Certificate includes more than one factory location and a declaration from the Manufacturer stating that the sample(s) submitted for evaluation is (are) representative of the products from each factory has been provided.....:	<input type="checkbox"/> Yes <input checked="" type="checkbox"/> Not applicable
<p>When differences exist; they shall be identified in the General product information section.</p>	
<p>Name and address of factory (ies).....: Same as applicant</p>	

General product information and other remarks:

The cell consists of the positive electrode plate, negative electrode plate, separator, electrolyte, case. The positive and negative electrode plates are housed in the case in the state being separated by the separator.

Model Differences:

Models IMR18650T12, IMR18650T16, IMR18650T18, IMR18650L18, INR18650T20, INR18650L20, INR18650T22, INR18650L22, INR18650T25, INR18650L25, INR18650T26, INR18650L26, INR18650L30, INR18650L32 are identical to each other except for capacity and colour. All the models are manufactured through the same production process, the tested models IMR18650T12, IMR18650T16, IMR18650T18, INR18650L22, INR18650L26, INR18650L32 are representatives of other models.

The main features of the cell are shown as below (clause 7.1.1):

Model (cell)	Nominal capacity	Nominal voltage	Nominal Charge Current	Nominal Discharge Current	Maximum Charge Current	Maximum Discharge Current	Maximum Charge Voltage	Final Voltage
IMR18650T12	1200mAh	3.7V	600mA	600mA	1200mA	1200mA	4.25V	2.5V
IMR18650T16	1600mAh	3.7V	800mA	800mA	1600mA	1600mA	4.25V	2.5V
IMR18650T18	1800mAh	3.7V	900mA	900mA	1800mA	1800mA	4.25V	2.5V
IMR18650L18	1800mAh	3.7V	900mA	900mA	1800mA	1800mA	4.25V	2.5V
INR18650T20	2000mAh	3.7V	1000mA	1000mA	2000mA	2000mA	4.25V	2.5V
INR18650L20	2000mAh	3.7V	1000mA	1000mA	2000mA	2000mA	4.25V	2.5V
INR18650T22	2200mAh	3.7V	1100mA	1100mA	2200mA	2200mA	4.25V	2.5V
INR18650L22	2200mAh	3.7V	1100mA	1100mA	2200mA	2200mA	4.25V	2.5V
INR18650T25	2500mAh	3.7V	1250mA	1250mA	2500mA	2500mA	4.25V	2.5V
INR18650L25	2500mAh	3.7V	1250mA	1250mA	2500mA	2500mA	4.25V	2.5V
INR18650T26	2600mAh	3.7V	1300mA	1300mA	2600mA	2600mA	4.25V	2.5V
INR18650L26	2600mAh	3.7V	1300mA	1300mA	2600mA	2600mA	4.25V	2.5V
INR18650L30	3000mAh	3.7V	1500mA	1500mA	3000mA	3000mA	4.25V	2.5V
INR18650L32	3200mAh	3.7V	1600mA	1600mA	3200mA	3200mA	4.25V	2.5V

The main features of the cell are shown as below (clause 7.1.2):

Model (cell)	Upper limit charge voltage	Taper-off current	Lower charge temperature	Upper charge temperature
IMR18650 T12	4.25V	60mA	0°C	45°C
IMR18650 T16	4.25V	80mA	0°C	45°C
IMR18650 T18	4.25V	90mA	0°C	45°C
IMR18650 L18	4.25V	90mA	0°C	45°C
INR18650 T20	4.25V	100mA	0°C	45°C
INR18650 L20	4.25V	100mA	0°C	45°C
INR18650 T22	4.25V	110mA	0°C	45°C
INR18650 L22	4.25V	110mA	0°C	45°C
INR18650 T25	4.25V	125mA	0°C	45°C
INR18650 L25	4.25V	125mA	0°C	45°C
INR18650 T26	4.25V	130mA	0°C	45°C
INR18650 L26	4.25V	130mA	0°C	45°C
INR18650 L30	4.25V	150mA	0°C	45°C
INR18650 L32	4.25V	160mA	0°C	45°C

Construction:

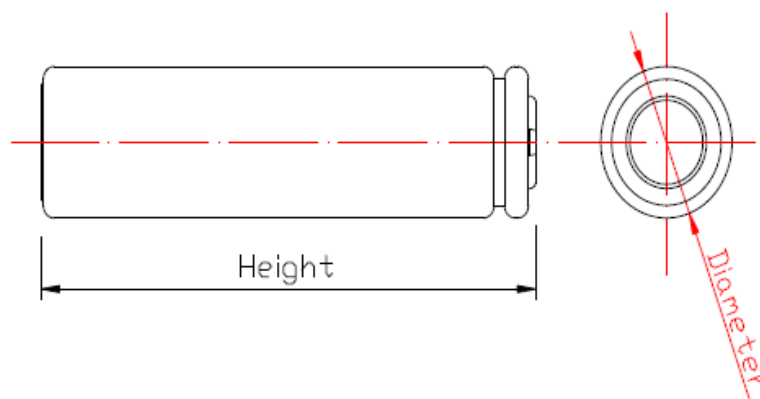

Height: 65.0±0.3mm; Diameter: 18.3±0.3mm
Cell

Circuit diagram:

None, cell only.

IEC 62133-2			
Clause	Requirement + Test	Result - Remark	Verdict
4	PARAMETER MEASUREMENT TOLERANCES		P
	Parameter measurement tolerances		P
5	GENERAL SAFETY CONSIDERATIONS		P
5.1	General		P
	Cells and batteries so designed and constructed that they are safe under conditions of both intended use and reasonably foreseeable misuse		P
5.2	Insulation and wiring		N/A
	The insulation resistance between the positive terminal and externally exposed metal surfaces of the battery (excluding electrical contact surfaces) is not less than 5 MΩ	Cell only.	N/A
	Insulation resistance (MΩ).....:		—
	Internal wiring and insulation are sufficient to withstand maximum anticipated current, voltage and temperature requirements		N/A
	Orientation of wiring maintains adequate clearances and creepage distances between conductors		N/A
	Mechanical integrity of internal connections accommodates reasonably foreseeable misuse		N/A
5.3	Venting		P
	Battery cases and cells incorporate a pressure relief mechanism or are constructed so that they relieve excessive internal pressure at a value and rate that will preclude rupture, explosion and self-ignition	Venting mechanism exists on the top of cylindrical cell.	P
	Encapsulation used to support cells within an outer casing does not cause the battery to overheat during normal operation nor inhibit pressure relief		N/A
5.4	Temperature, voltage and current management		N/A
	Batteries are designed such that abnormal temperature rise conditions are prevented	Cell only.	N/A
	Batteries are designed to be within temperature, voltage and current limits specified by the cell manufacturer		N/A
	Batteries are provided with specifications and charging instructions for equipment manufacturers so that specified chargers are designed to maintain charging within the temperature, voltage and current limits specified		N/A
5.5	Terminal contacts		P
	The size and shape of the terminal contacts ensure that they can carry the maximum anticipated current		P

IEC 62133-2			
Clause	Requirement + Test	Result - Remark	Verdict
	External terminal contact surfaces are formed from conductive materials with good mechanical strength and corrosion resistance		P
	Terminal contacts are arranged to minimize the risk of short circuits		P
5.6	Assembly of cells into batteries		N/A
5.6.1	General		N/A
	Each battery has an independent control and protection for current, voltage, temperature and any other parameter required for safety and to maintain the cells within their operating region	Cell only.	N/A
	This protection may be provided external to the battery such as within the charger or the end devices		N/A
	If protection is external to the battery, the manufacturer of the battery provide this safety relevant information to the external device manufacturer for implementation		N/A
	If there is more than one battery housed in a single battery case, each battery has protective circuitry that can maintain the cells within their operating regions		N/A
	Manufacturers of cells specify current, voltage and temperature limits so that the battery manufacturer/designer may ensure proper design and assembly		N/A
	Batteries that are designed for the selective discharge of a portion of their series connected cells incorporate circuitry to prevent operation of cells outside the limits specified by the cell manufacturer		N/A
	Protective circuit components are added as appropriate and consideration given to the end-device application		N/A
	The manufacturer of the battery provide a safety analysis of the battery safety circuitry with a test report including a fault analysis of the protection circuit under both charging and discharging conditions confirming the compliance		N/A
5.6.2	Design recommendation		N/A
	For the battery consisting of a single cell or a single cellblock, it is recommended that the charging voltage of the cell does not exceed the upper limit of the charging voltage specified in Table 2	Cell only.	N/A

IEC 62133-2			
Clause	Requirement + Test	Result - Remark	Verdict
	For the battery consisting of series-connected plural single cells or series-connected plural cellblocks, it is recommended that the voltages of any one of the single cells or single cellblocks does not exceed the upper limit of the charging voltage, specified in Table 2, by monitoring the voltage of every single cell or the single cellblocks		N/A
	For the battery consisting of series-connected plural single cells or series-connected plural cellblocks, it is recommended that charging is stopped when the upper limit of the charging voltage is exceeded for any one of the single cells or single cellblocks by measuring the voltage of every single cell or the single cellblocks		N/A
	For batteries consisting of series-connected cells or cell blocks, nominal charge voltage are not counted as an overcharge protection		N/A
	For batteries consisting of series-connected cells or cell blocks, cells have closely matched capacities, be of the same design, be of the same chemistry and be from the same manufacturer		N/A
	It is recommended that the cells and cell blocks are not discharged beyond the cell manufacturer's specified final voltage		N/A
	For batteries consisting of series-connected cells or cell blocks, cell balancing circuitry are incorporated into the battery management system		N/A
5.6.3	Mechanical protection for cells and components of batteries	Cell only.	N/A
	Mechanical protection for cells, cell connections and control circuits within the battery are provided to prevent damage as a result of intended use and reasonably foreseeable misuse		N/A
	The mechanical protection can be provided by the battery case or it can be provided by the end product enclosure for those batteries intended for building into an end product		N/A
	The battery case and compartments housing cells are designed to accommodate cell dimensional tolerances during charging and discharging as recommended by the cell manufacturer		N/A
	For batteries intended for building into a portable end product, testing with the battery installed within the end product is considered when conducting mechanical tests		N/A
5.7	Quality plan		P

IEC 62133-2			
Clause	Requirement + Test	Result - Remark	Verdict
	The manufacturer prepares and implements a quality plan that defines procedures for the inspection of materials, components, cells and batteries and which covers the whole process of producing each type of cell or battery	Complied. ISO 9001: 2015 certificate provided.	P
5.8	Battery safety components	See TABLE: Critical components information	N/A

6	TYPE TEST AND SAMPLE SIZE		P
	Tests are made with the number of cells or batteries specified in Table 1 using cells or batteries that are not more than six months old		P
	The internal resistance of coin cells are measured in accordance with Annex D. Coin cells with internal resistance less than or equal to 3 Ω are tested in accordance with Table 1	Not coin cells	N/A
	Unless otherwise specified, tests are carried out in an ambient temperature of 20 °C \pm 5 °C		P
	The safety analysis of 5.6.1 identify those components of the protection circuit that are critical for short-circuit, overcharge and over discharge protection	Cell only.	N/A
	When conducting the short-circuit test, consideration is given to the simulation of any single fault condition that is likely to occur in the protecting circuit that would affect the short-circuit test	Cell only.	N/A

7	SPECIFIC REQUIREMENTS AND TESTS		P
7.1	Charging procedure for test purposes		P
7.1.1	First procedure		P
	This charging procedure applies to subclauses other than those specified in 7.1.2		P
	Unless otherwise stated in this document, the charging procedure for test purposes is carried out in an ambient temperature of 20 °C \pm 5 °C, using the method declared by the manufacturer		P
	Prior to charging, the battery has been discharged at 20 °C \pm 5 °C at a constant current of 0,2 It A down to a specified final voltage		P
7.1.2	Second procedure		P
	This charging procedure applies only to 7.3.1, 7.3.4, 7.3.5, and 7.3.9		P

IEC 62133-2			
Clause	Requirement + Test	Result - Remark	Verdict
	After stabilization for 1 h to 4 h, at an ambient temperature of the highest test temperature and the lowest test temperature, respectively, as specified in Table 2, cells are charged by using the upper limit charging voltage and maximum charging current, until the charging current is reduced to 0,05 It A, using a constant current to constant voltage charging method	Charge temperature range: 0-45°C declared. 0°C used for lower limit tests. 45°C used for upper limit tests.	P
7.2	Intended use		P
7.2.1	Continuous charging at constant voltage (cells)	Tested complied.	P
	Fully charged cells are subjected for 7 days to a charge using the charging method for current and standard voltage specified by the cell manufacturer	Charging for 7 days with 0.5C.	P
	Results: no fire, no explosion, no leakage	(See appended table 7.2.1)	P
7.2.2	Case stress at high ambient temperature (battery)	Cell only.	N/A
	Oven temperature (°C).....		—
	Results: no physical distortion of the battery case resulting in exposure of internal protective components and cells		N/A
7.3	Reasonably foreseeable misuse		P
7.3.1	External short-circuit (cell)	Tested complied.	P
	The cells were tested until one of the following occurred:		P
	- 24 hours elapsed; or		N/A
	- The case temperature declined by 20 % of the maximum temperature rise		P
	Results: no fire, no explosion.....	(See appended table 7.3.1)	P
7.3.2	External short-circuit (battery)	Cell only.	N/A
	The batteries were tested until one of the following occurred:		N/A
	- 24 hours elapsed; or		N/A
	- The case temperature declined by 20 % of the maximum temperature rise		N/A
	In case of rapid decline in short circuit current, the battery pack remained on test for an additional one hour after the current reached a low end steady state condition		N/A
	A single fault in the discharge protection circuit is conducted on one to four (depending upon the protection circuit) of the five samples before conducting the short-circuit test		N/A

IEC 62133-2			
Clause	Requirement + Test	Result - Remark	Verdict
	A single fault applies to protective component parts such as MOSFET (metal oxide semiconductor field-effect transistor), fuse, thermostat or positive temperature coefficient (PTC) thermistor		N/A
	Results: no fire, no explosion..... :		N/A
7.3.3	Free fall	Tested complied.	P
	Results: no fire, no explosion	No fire. No explosion	P
7.3.4	Thermal abuse (cells)	Tested complied.	P
	Oven temperature (°C)..... :	130°C	—
	Results: no fire, no explosion	No fire. No explosion	P
7.3.5	Crush (cells)	Tested complied.	P
	The crushing force was released upon:		P
	- The maximum force of 13 kN ± 0,78 kN has been applied; or		P
	- An abrupt voltage drop of one-third of the original voltage has been obtained		N/A
	Results: no fire, no explosion..... :	(See appended table 7.3.5)	P
7.3.6	Over-charging of battery	Cell only.	N/A
	The supply voltage which is:		N/A
	- 1,4 times the upper limit charging voltage presented in Table A.1 (but not to exceed 6,0 V) for single cell/cell block batteries or		N/A
	- 1,2 times the upper limit charging voltage resented in Table A.1 per cell for series connected multi-cell batteries, and		N/A
	- Sufficient to maintain a current of 2,0 It A throughout the duration of the test or until the supply voltage is reached		N/A
	Test was continued until the temperature of the outer casing:		N/A
	- Reached steady state conditions (less than 10 °C change in 30-minute period); or		N/A
	- Returned to ambient		N/A
	Results: no fire, no explosion..... :		N/A
7.3.7	Forced discharge (cells)	Tested complied.	P
	Discharge a single cell to the lower limit discharge voltage specified by the cell manufacturer		P
	The discharged cell is then subjected to a forced discharge at 1 It A to the negative value of the upper limit charging voltage		P

IEC 62133-2			
Clause	Requirement + Test	Result - Remark	Verdict
	- The discharge voltage reaches the negative value of upper limit charging voltage within the testing duration. The voltage is maintained at the negative value of the upper limit charging voltage by reducing the current for the remainder of the testing duration		N/A
	- The discharge voltage does not reach the negative value of upper limit charging voltage within the testing duration. The test is terminated at the end of the testing duration		P
	Results: no fire, no explosion..... :	(See appended table 7.3.7)	P
7.3.8	Mechanical tests (batteries)		N/A
7.3.8.1	Vibration	Cell only.	N/A
	Results: no fire, no explosion, no rupture, no leakage or venting. :		N/A
7.3.8.2	Mechanical shock	Cell only.	N/A
	Results: no leakage, no venting, no rupture, no explosion and no fire..... :		N/A
7.3.9	Design evaluation – Forced internal short-circuit (cells)	Tested complied.	P
	The cells complied with national requirement for..... :	France, Japan, Korea, Switzerland	—
	The pressing was stopped upon:		P
	- A voltage drop of 50 mV has been detected; or		N/A
	- The pressing force of 800 N (cylindrical cells) or 400 N (prismatic cells) has been reached	800N for cylindrical cells.	P
	Results: no fire..... :	(See appended table 7.3.9)	P
8	INFORMATION FOR SAFETY		P
8.1	General		P
	Manufacturers of secondary cells provides information about current, voltage and temperature limits of their products	Information for safety mentioned in manufacturer's specifications.	P
	Manufacturers of batteries provides information regarding how to minimize and mitigate hazards to equipment manufacturers or end-users		N/A
	Systems analyses are performed by device manufacturers to ensure that a particular battery design prevents hazards from occurring during use of a product		N/A
	As appropriate, any information relating to hazard avoidance resulting from a system analysis is provided to the end user		N/A

IEC 62133-2			
Clause	Requirement + Test	Result - Remark	Verdict
	Do not allow children to replace batteries without adult supervision		N/A
8.2	Small cell and battery safety information	Not small cells.	N/A
	The following warning language is to be provided with the information packaged with the small cells and batteries or equipment using them:		N/A
	- Keep small cells and batteries which are considered swallowable out of the reach of children		N/A
	- Swallowing may lead to burns, perforation of soft tissue, and death. Severe burns can occur within 2 h of ingestion		N/A
	- In case of ingestion of a cell or battery, seek medical assistance promptly		N/A
9	MARKING		P
9.1	Cell marking		P
	Cells are marked as specified in IEC 61960, except coin cells		N/A
	Coin cells whose external surface area is too small to accommodate the markings on the cells show the designation and polarity		N/A
	By agreement between the cell manufacturer and the battery and/or end product manufacturer, component cells used in the manufacture of a battery need not be marked	Agreement between the cell manufacturer and user provided.	P
9.2	Battery marking	Cell only.	N/A
	Batteries are marked as specified in IEC 61960, except for coin batteries		N/A
	Coin batteries whose external surface area is too small to accommodate the markings on the batteries show the designation and polarity		N/A
	Batteries are marked with an appropriate caution statement		N/A
	- Terminals have clear polarity marking on the external surface of the battery, or		N/A
	- Not be marked with polarity markings if the design of the external connector prevents reverse polarity connections		N/A
9.3	Caution for ingestion of small cells and batteries	Not small cells.	N/A
	Coin cells and batteries identified as small batteries include a caution statement regarding the hazards of ingestion in accordance with 8.2	Not coin cells.	N/A

IEC 62133-2			
Clause	Requirement + Test	Result - Remark	Verdict
	Small cells and batteries are intended for direct sale in consumer-replaceable applications, caution for ingestion is given on the immediate package		N/A
9.4	Other information		N/A
	The following information are marked on or supplied with the battery:		N/A
	- Storage and disposal instructions		N/A
	- Recommended charging instructions		N/A

10	PACKAGING AND TRANSPORT		N/A
	Packaging for coin cells are not be small enough to fit within the limits of the ingestion gauge of Figure 3	Not coin cells.	N/A

ANNEX A	CHARGING AND DISCHARGING RANGE OF SECONDARY LITHIUM ION CELLS FOR SAFE USE		P
A.1	General		P
A.2	Safety of lithium ion secondary battery	Complied.	P
A.3	Consideration on charging voltage	Complied.	P
A.3.1	General		P
A.3.2	Upper limit charging voltage	4.25V applied.	P
A.3.2.1	General		P
A.3.2.2	Explanation of safety viewpoint		P
A.3.2.3	Safety requirements, when different upper limit charging voltage is applied	4.25V applied.	N/A
A.4	Consideration of temperature and charging current		P
A.4.1	General		P
A.4.2	Recommended temperature range	Charging temperature range declared by client is: 0-45°C	P
A.4.2.1	General		P
A.4.2.2	Safety consideration when a different recommended temperature range is applied		N/A
A.4.3	High temperature range		N/A
A.4.3.1	General		N/A
A.4.3.2	Explanation of safety viewpoint		N/A
A.4.3.3	Safety considerations when specifying charging conditions in the high temperature range		N/A
A.4.3.4	Safety considerations when specifying a new upper limit in the high temperature range		N/A

IEC 62133-2			
Clause	Requirement + Test	Result - Remark	Verdict
A.4.4	Low temperature range		N/A
A.4.4.1	General		N/A
A.4.4.2	Explanation of safety viewpoint		N/A
A.4.4.3	Safety considerations, when specifying charging conditions in the low temperature range		N/A
A.4.4.4	Safety considerations when specifying a new lower limit in the low temperature range		N/A
A.4.5	Scope of the application of charging current		P
A.4.6	Consideration of discharge		P
A.4.6.1	General		P
A.4.6.2	Final discharge voltage and explanation of safety viewpoint	Cell specified final voltage 2.5V, not exceed 2.5V specified by cell manufacturer.	P
A.4.6.3	Discharge current and temperature range		P
A.4.6.4	Scope of application of the discharging current		P
A.5	Sample preparation		P
A.5.1	General		P
A.5.2	Insertion procedure for nickel particle to generate internal short		P
A.5.3	Disassembly of charged cell		P
A.5.4	Shape of nickel particle		P
A.5.5	Insertion of nickel particle in cylindrical cell		P
A.5.5.1	Insertion of nickel particle in winding core		P
A.5.5.2	Marking the position of the nickel particle on both ends of the winding core of the separator		P
A.5.6	Insertion of nickel particle in prismatic cell		N/A
A.6	Experimental procedure of the forced internal short-circuit test		P
A.6.1	Material and tools for preparation of nickel particle		P
A.6.2	Example of a nickel particle preparation procedure		P
A.6.3	Positioning (or placement) of a nickel particle		P
A.6.4	Damaged separator precaution		P
A.6.5	Caution for rewinding separator and electrode		P
A.6.6	Insulation film for preventing short-circuit		P
A.6.7	Caution when disassembling a cell		P
A.6.8	Protective equipment for safety		P
A.6.9	Caution in the case of fire during disassembling		P

IEC 62133-2			
Clause	Requirement + Test	Result - Remark	Verdict
A.6.10	Caution for the disassembling process and pressing the electrode core		P
A.6.11	Recommended specifications for the pressing device		P
ANNEX B	RECOMMENDATIONS TO EQUIPMENT MANUFACTURERS AND BATTERY ASSEMBLERS		N/A
ANNEX C	RECOMMENDATIONS TO THE END-USERS		N/A
ANNEX D	MEASUREMENT OF THE INTERNAL AC RESISTANCE FOR COIN CELLS		N/A
D.1	General	Not coin cells.	N/A
D.2	Method		N/A
	A sample size of three coin cells is required for this measurement		N/A
	Coin cells with an internal resistance greater than 3 Ω require no further testing		N/A
	Coin cells with an internal resistance less than or equal to 3 Ω are subjected to the testing according to Clause 6 and Table 1		N/A
ANNEX E	PACKAGING AND TRANSPORT		N/A
ANNEX F	COMPONENT STANDARDS REFERENCES		N/A

IEC 62133-2				
Clause	Requirement + Test	Result - Remark		Verdict
7.2.1	TABLE: Continuous charging at constant voltage (cells)			P
Sample No.	Recommended charging voltage Vc (Vdc)	Recommended charging current I _{rec} (A)	OCV before test (Vdc)	Results
Model: IMR18650T12				
NCT23027001-IMR18650T12-C1#	4.25	0.60	4.24	P
NCT23027001-IMR18650T12-C2#	4.25	0.60	4.24	P
NCT23027001-IMR18650T12-C3#	4.25	0.60	4.24	P
NCT23027001-IMR18650T12-C4#	4.25	0.60	4.24	P
NCT23027001-IMR18650T12-C5#	4.25	0.60	4.24	P
Model: IMR18650T16				
NCT23027001-IMR18650T16-C1#	4.25	0.80	4.24	P
NCT23027001-IMR18650T16-C2#	4.25	0.80	4.24	P
NCT23027001-IMR18650T16-C3#	4.25	0.80	4.23	P
NCT23027001-IMR18650T16-C4#	4.25	0.80	4.24	P
NCT23027001-IMR18650T16-C5#	4.25	0.80	4.23	P
Model: IMR18650T18				
NCT23027001-IMR18650T18-C1#	4.25	0.90	4.24	P
NCT23027001-IMR18650T18-C2#	4.25	0.90	4.24	P
NCT23027001-IMR18650T18-C3#	4.25	0.90	4.24	P
NCT23027001-IMR18650T18-C4#	4.25	0.90	4.24	P
NCT23027001-IMR18650T18-C5#	4.25	0.90	4.23	P
Model: INR18650L22				
NCT23027001-INR18650L22-C1#	4.25	1.10	4.23	P
NCT23027001-INR18650L22-C2#	4.25	1.10	4.23	P

IEC 62133-2				
Clause	Requirement + Test		Result - Remark	Verdict
NCT23027001- INR18650L22-C3#	4.25	1.10	4.24	P
NCT23027001- INR18650L22-C4#	4.25	1.10	4.23	P
NCT23027001- INR18650L22-C5#	4.25	1.10	4.23	P
Model: INR18650L26				
NCT23027001- INR18650L26-C1#	4.25	1.30	4.24	P
NCT23027001- INR18650L26-C2#	4.25	1.30	4.23	P
NCT23027001- INR18650L26-C3#	4.25	1.30	4.23	P
NCT23027001- INR18650L26-C4#	4.25	1.30	4.24	P
NCT23027001- INR18650L26-C5#	4.25	1.30	4.23	P
Model: INR18650L32				
NCT23027001- INR18650L32-C1#	4.25	1.60	4.23	P
NCT23027001- INR18650L32-C2#	4.25	1.60	4.23	P
NCT23027001- INR18650L32-C3#	4.25	1.60	4.23	P
NCT23027001- INR18650L32-C4#	4.25	1.60	4.24	P
NCT23027001- INR18650L32-C5#	4.25	1.60	4.23	P
Supplementary information: - No fire or explosion - No leakage				

7.3.1	TABLE: External short circuit (cell)				P
Sample No.	Ambient (°C)	OCV at start of test (Vdc)	Resistance of circuit (mΩ)	Maximum case temperature rise ΔT (K) °C	Results
Model: IMR18650T12					
Samples charged at charging temperature upper limit (45°C)					
NCT23027001- IMR18650T12-C6#	55.5	4.20	78.5	76.7	P
NCT23027001- IMR18650T12-C7#	55.5	4.21	83.2	80.2	P

IEC 62133-2					
Clause	Requirement + Test			Result - Remark	Verdict
NCT23027001-IMR18650T12-C8#	55.5	4.20	81.6	78.5	P
NCT23027001-IMR18650T12-C9#	55.5	4.20	80.2	82.3	P
NCT23027001-IMR18650T12-C10#	55.5	4.21	85.4	81.6	P
Samples charged at charging temperature lower limit (0°C)					
NCT23027001-IMR18650T12-C11#	55.6	4.14	84.6	82.3	P
NCT23027001-IMR18650T12-C12#	55.6	4.14	81.1	79.1	P
NCT23027001-IMR18650T12-C13#	55.6	4.13	79.4	80.3	P
NCT23027001-IMR18650T12-C14#	55.6	4.13	83.8	83.1	P
NCT23027001-IMR18650T12-C15#	55.6	4.14	82.6	77.5	P
Model: IMR18650T16					
Samples charged at charging temperature upper limit (45°C)					
NCT23027001-IMR18650T16-C6#	54.8	4.20	81.0	77.7	P
NCT23027001-IMR18650T16-C7#	54.8	4.21	79.8	74.1	P
NCT23027001-IMR18650T16-C8#	54.8	4.20	83.6	75.6	P
NCT23027001-IMR18650T16-C9#	54.8	4.20	85.4	75.4	P
NCT23027001-IMR18650T16-C10#	54.8	4.21	86.7	77.9	P
Samples charged at charging temperature lower limit (0°C)					
NCT23027001-IMR18650T16-C11#	54.6	4.13	82.7	81.3	P
NCT23027001-IMR18650T16-C12#	54.6	4.14	86.2	72.8	P
NCT23027001-IMR18650T16-C13#	54.6	4.13	83.3	79.1	P
NCT23027001-IMR18650T16-C14#	54.6	4.13	85.8	73.3	P
NCT23027001-IMR18650T16-C15#	54.6	4.14	81.4	81.0	P
Model: IMR18650T18					

IEC 62133-2					
Clause	Requirement + Test			Result - Remark	Verdict
Samples charged at charging temperature upper limit (45°C)					
NCT23027001-IMR18650T18-C6#	55.6	4.21	83.2	80.3	P
NCT23027001-IMR18650T18-C7#	55.6	4.21	78.9	82.4	P
NCT23027001-IMR18650T18-C8#	55.6	4.20	81.5	76.6	P
NCT23027001-IMR18650T18-C9#	55.6	4.21	85.6	81.9	P
NCT23027001-IMR18650T18-C10#	55.6	4.22	82.1	78.3	P
Samples charged at charging temperature lower limit (0°C)					
NCT23027001-IMR18650T18-C11#	55.6	4.13	83.6	79.4	P
NCT23027001-IMR18650T18-C12#	55.6	4.14	82.4	81.9	P
NCT23027001-IMR18650T18-C13#	55.6	4.14	79.6	84.0	P
NCT23027001-IMR18650T18-C14#	55.6	4.13	81.1	77.6	P
NCT23027001-IMR18650T18-C15#	55.6	4.13	82.5	81.1	P
Model: INR18650L22					
Samples charged at charging temperature upper limit (45°C)					
NCT23027001-INR18650L22-C6#	55.2	4.19	78.7	74.9	P
NCT23027001-INR18650L22-C7#	55.2	4.20	85.3	81.4	P
NCT23027001-INR18650L22-C8#	55.2	4.19	82.6	75.4	P
NCT23027001-INR18650L22-C9#	55.2	4.20	76.2	72.7	P
NCT23027001-INR18650L22-C10#	55.2	4.19	84.8	78.3	P
Samples charged at charging temperature lower limit (0°C)					
NCT23027001-INR18650L22-C11#	55.4	4.13	79.2	79.5	P
NCT23027001-INR18650L22-C12#	55.4	4.14	88.7	84.2	P
NCT23027001-INR18650L22-C13#	55.4	4.13	80.3	80.4	P

IEC 62133-2					
Clause	Requirement + Test			Result - Remark	Verdict
NCT23027001- INR18650L22-C14#	55.4	4.14	84.4	81.6	P
NCT23027001- INR18650L22-C15#	55.4	4.14	89.7	83.5	P
Model: INR18650L26					
Samples charged at charging temperature upper limit (45°C)					
NCT23027001- INR18650L26-C6#	54.9	4.20	83.2	72.9	P
NCT23027001- INR18650L26-C7#	54.9	4.20	88.0	70.8	P
NCT23027001- INR18650L26-C8#	54.9	4.21	81.1	73.8	P
NCT23027001- INR18650L26-C9#	54.9	4.20	86.4	72.6	P
NCT23027001- INR18650L26-C10#	54.9	4.21	84.5	70.4	P
Samples charged at charging temperature lower limit (0°C)					
NCT23027001- INR18650L26-C11#	55.3	4.14	82.6	80.2	P
NCT23027001- INR18650L26-C12#	55.3	4.14	83.9	79.5	P
NCT23027001- INR18650L26-C13#	55.3	4.13	86.8	80.3	P
NCT23027001- INR18650L26-C14#	55.3	4.13	80.7	82.0	P
NCT23027001- INR18650L26-C15#	55.3	4.14	82.2	81.2	P
Model: INR18650L32					
Samples charged at charging temperature upper limit (45°C)					
NCT23027001- INR18650L32-C6#	55.5	4.20	83.4	71.6	P
NCT23027001- INR18650L32-C7#	55.5	4.21	79.1	76.7	P
NCT23027001- INR18650L32-C8#	55.5	4.20	86.5	70.9	P
NCT23027001- INR18650L32-C9#	55.5	4.21	75.8	74.6	P
NCT23027001- INR18650L32-C10#	55.5	4.20	80.4	75.5	P
Samples charged at charging temperature lower limit (0°C)					
NCT23027001-	55.6	4.13	85.9	75.8	P

IEC 62133-2						
Clause	Requirement + Test			Result - Remark		Verdict
INR18650L32-C11#						
NCT23027001- INR18650L32-C12#	55.6	4.14	77.3	77.4		P
NCT23027001- INR18650L32-C13#	55.6	4.13	82.5	84.9		P
NCT23027001- INR18650L32-C14#	55.6	4.14	87.2	79.5		P
NCT23027001- INR18650L32-C15#	55.6	4.14	76.6	80.3		P
Supplementary information: - No fire or explosion						

7.3.2	TABLE: External short circuit (battery)						N/A
Sample No.	Ambient T (°C)	OCV before test (Vdc)	Resistance of circuit (mΩ)	Maximum case temperature rise ΔT (K) °C	Component single fault condition	Results	
Supplementary information:							

7.3.5	TABLE: Crush (cells)				P
Sample No.	OCV before test (Vdc)	OCV at removal of crushing force (Vdc)	Maximum force applied to the cell during crush (kN)	Results	
Model: IMR18650T12					
Samples charged at charging temperature upper limit (45°C)					
NCT23027001- IMR18650T12-C29#	4.21	4.20	12.99	P	
NCT23027001- IMR18650T12-C30#	4.21	4.21	13.01	P	
NCT23027001- IMR18650T12-C31#	4.20	4.19	12.96	P	
NCT23027001- IMR18650T12-C32#	4.20	4.20	13.03	P	

IEC 62133-2				
Clause	Requirement + Test		Result - Remark	Verdict
NCT23027001- IMR18650T12-C33#	4.21	4.21	13.01	P
Samples charged at charging temperature lower limit (0°C)				
NCT23027001- IMR18650T12-C34#	4.14	4.14	13.02	P
NCT23027001- IMR18650T12-C35#	4.13	4.13	13.00	P
NCT23027001- IMR18650T12-C36#	4.13	4.12	12.98	P
NCT23027001- IMR18650T12-C37#	4.14	4.13	13.01	P
NCT23027001- IMR18650T12-C38#	4.13	4.13	13.03	P
Model: IMR18650T16				
Samples charged at charging temperature upper limit (45°C)				
NCT23027001- IMR18650T16-C29#	4.21	4.20	13.02	P
NCT23027001- IMR18650T16-C30#	4.20	4.20	13.01	P
NCT23027001- IMR18650T16-C31#	4.21	4.21	12.97	P
NCT23027001- IMR18650T16-C32#	4.21	4.20	13.01	P
NCT23027001- IMR18650T16-C33#	4.20	4.19	13.03	P
Samples charged at charging temperature lower limit (0°C)				
NCT23027001- IMR18650T16-C34#	4.13	4.12	13.02	P
NCT23027001- IMR18650T16-C35#	4.13	4.13	13.01	P
NCT23027001- IMR18650T16-C36#	4.14	4.13	13.03	P
NCT23027001- IMR18650T16-C37#	4.13	4.12	13.02	P
NCT23027001- IMR18650T16-C38#	4.14	4.14	13.03	P
Model: IMR18650T18				
Samples charged at charging temperature upper limit (45°C)				
NCT23027001- IMR18650T18-C29#	4.20	4.19	13.03	P
NCT23027001-	4.21	4.21	12.99	P

IEC 62133-2				
Clause	Requirement + Test		Result - Remark	Verdict
IMR18650T18-C30#				
NCT23027001- IMR18650T18-C31#	4.21	4.20	13.01	P
NCT23027001- IMR18650T18-C32#	4.20	4.20	13.02	P
NCT23027001- IMR18650T18-C33#	4.21	4.21	13.01	P
Samples charged at charging temperature lower limit (0°C)				
NCT23027001- IMR18650T18-C34#	4.13	4.12	12.98	P
NCT23027001- IMR18650T18-C35#	4.14	4.14	13.02	P
NCT23027001- IMR18650T18-C36#	4.14	4.13	12.96	P
NCT23027001- IMR18650T18-C37#	4.13	4.13	13.01	P
NCT23027001- IMR18650T18-C38#	4.13	4.13	13.02	P
Model: INR18650L22				
Samples charged at charging temperature upper limit (45°C)				
NCT23027001- INR18650L22-C29#	4.19	4.19	13.02	P
NCT23027001- INR18650L22-C30#	4.20	4.20	12.96	P
NCT23027001- INR18650L22-C31#	4.19	4.19	13.03	P
NCT23027001- INR18650L22-C32#	4.19	4.18	12.99	P
NCT23027001- INR18650L22-C33#	4.20	4.20	13.00	P
Samples charged at charging temperature lower limit (0°C)				
NCT23027001- INR18650L22-C34#	4.14	4.14	12.98	P
NCT23027001- INR18650L22-C35#	4.13	4.12	13.01	P
NCT23027001- INR18650L22-C36#	4.14	4.14	12.97	P
NCT23027001- INR18650L22-C37#	4.13	4.13	13.03	P
NCT23027001- INR18650L22-C38#	4.14	4.14	12.95	P
Model: INR18650L26				

IEC 62133-2				
Clause	Requirement + Test		Result - Remark	Verdict
Samples charged at charging temperature upper limit (45°C)				
NCT23027001- INR18650L26-C29#	4.20	4.19	13.03	P
NCT23027001- INR18650L26-C30#	4.21	4.20	13.01	P
NCT23027001- INR18650L26-C31#	4.21	4.21	13.03	P
NCT23027001- INR18650L26-C32#	4.20	4.19	13.02	P
NCT23027001- INR18650L26-C33#	4.20	4.20	13.01	P
Samples charged at charging temperature lower limit (0°C)				
NCT23027001- INR18650L26-C34#	4.14	4.13	13.01	P
NCT23027001- INR18650L26-C35#	4.13	4.13	12.97	P
NCT23027001- INR18650L26-C36#	4.13	4.12	13.02	P
NCT23027001- INR18650L26-C37#	4.14	4.14	12.98	P
NCT23027001- INR18650L26-C38#	4.14	4.13	13.01	P
Model: INR18650L32				
Samples charged at charging temperature upper limit (45°C)				
NCT23027001- INR18650L32-C29#	4.20	4.20	13.02	P
NCT23027001- INR18650L32-C30#	4.21	4.20	12.96	P
NCT23027001- INR18650L32-C31#	4.21	4.21	13.00	P
NCT23027001- INR18650L32-C32#	4.20	4.20	12.98	P
NCT23027001- INR18650L32-C33#	4.21	4.21	13.03	P
Samples charged at charging temperature lower limit (0°C)				
NCT23027001- INR18650L32-C34#	4.14	4.14	12.97	P
NCT23027001- INR18650L32-C35#	4.13	4.13	13.01	P
NCT23027001- INR18650L32-C36#	4.14	4.14	12.99	P

IEC 62133-2				
Clause	Requirement + Test		Result - Remark	Verdict
NCT23027001- INR18650L32-C37#	4.13	4.12	13.02	P
NCT23027001- INR18650L32-C38#	4.14	4.14	12.98	P
Note: A 13KN force applied at the longitudinal axis of cylindrical cells. No voltage abrupt drop occurred.				
Supplementary information: - No fire or explosion				

7.3.6	TABLE: Over-charging of battery				N/A
Constant charging current (A)					—
Supply voltage (Vdc).....					—
Sample No.	OCV before charging (Vdc)	Total charging time (minute)	Maximum outer case temperature (°C)	Results	
Supplementary information:					

7.3.7	TABLE: Forced discharge (cells)				P
Sample No.	OCV before application of reverse charge (Vdc)	Measured reverse charge I_t (A)	Lower limit discharge voltage (Vdc)	Results	
Model: IMR18650T12					
NCT23027001- IMR18650T12- C39#	3.02	1.20	2.50	P	
NCT23027001- IMR18650T12- C40#	3.00	1.20	2.50	P	
NCT23027001- IMR18650T12- C41#	3.01	1.20	2.50	P	
NCT23027001- IMR18650T12- C42#	3.03	1.20	2.50	P	
NCT23027001- IMR18650T12- C43#	3.02	1.20	2.50	P	

IEC 62133-2				
Clause	Requirement + Test		Result - Remark	Verdict
Model: IMR18650T16				
NCT23027001- IMR18650T16- C39#	2.91	1.60	2.50	P
NCT23027001- IMR18650T16- C40#	2.92	1.60	2.50	P
NCT23027001- IMR18650T16- C41#	2.92	1.60	2.50	P
NCT23027001- IMR18650T16- C42#	2.91	1.60	2.50	P
NCT23027001- IMR18650T16- C43#	2.92	1.60	2.50	P
Model: IMR18650T18				
NCT23027001- IMR18650T18- C39#	3.04	1.80	2.50	P
NCT23027001- IMR18650T18- C40#	3.05	1.80	2.50	P
NCT23027001- IMR18650T18- C41#	3.06	1.80	2.50	P
NCT23027001- IMR18650T18- C42#	3.04	1.80	2.50	P
NCT23027001- IMR18650T18- C43#	3.08	1.80	2.50	P
Model: INR18650L22				
NCT23027001- INR18650L22- C39#	3.03	2.20	2.50	P
NCT23027001- INR18650L22- C40#	3.05	2.20	2.50	P
NCT23027001- INR18650L22- C41#	3.04	2.20	2.50	P
NCT23027001- INR18650L22- C42#	3.03	2.20	2.50	P

IEC 62133-2				
Clause	Requirement + Test		Result - Remark	Verdict
NCT23027001- INR18650L22- C43#	3.03	2.20	2.50	P
Model: INR18650L26				
NCT23027001- INR18650L26- C39#	2.93	2.60	2.50	P
NCT23027001- INR18650L26- C40#	2.94	2.60	2.50	P
NCT23027001- INR18650L26- C41#	2.93	2.60	2.50	P
NCT23027001- INR18650L26- C42#	2.93	2.60	2.50	P
NCT23027001- INR18650L26- C43#	2.94	2.60	2.50	P
Model: INR18650L32				
NCT23027001- INR18650L32- C39#	3.08	3.20	2.50	P
NCT23027001- INR18650L32- C40#	3.10	3.20	2.50	P
NCT23027001- INR18650L32- C41#	3.08	3.20	2.50	P
NCT23027001- INR18650L32- C42#	3.09	3.20	2.50	P
NCT23027001- INR18650L32- C43#	3.08	3.20	2.50	P
Supplementary information: - No fire or explosion				

7.3.8.1	TABLE: Vibration				N/A
Sample No.	OCV before test (Vdc)	OCV after test (Vdc)	Mass before test (g)	Mass after test (g)	Results

IEC 62133-2					
Clause	Requirement + Test			Result - Remark	Verdict
Supplementary information:					

7.3.8.2	TABLE: Mechanical shock					N/A
Sample No.	OCV before test (Vdc)	OCV after test (Vdc)	Mass before test (g)	Mass after test (g)	Results	
Supplementary information:						

7.3.9	TABLE: Forced internal short circuit (cells)					P
Sample No.	Chamber ambient T (°C)	OCV before test (Vdc)	Particle location ¹⁾	Maximum applied pressure (N)	Results	
Model: IMR18650T12						
Samples charged at charging temperature upper limit (45°C)						
NCT23027001-IMR18650T12-C44#	45	4.20	1	800	P	
NCT23027001-IMR18650T12-C45#	45	4.21	1	800	P	
NCT23027001-IMR18650T12-C46#	45	4.20	1	800	P	
NCT23027001-IMR18650T12-C47#	45	4.21	1	800	P	
NCT23027001-IMR18650T12-C48#	45	4.21	1	800	P	
Samples charged at charging temperature lower limit (0°C)						
NCT23027001-IMR18650T12-C49#	0	4.14	1	800	P	
NCT23027001-IMR18650T12-C50#	0	4.13	1	800	P	

IEC 62133-2					
Clause	Requirement + Test			Result - Remark	Verdict
NCT23027001- IMR18650T12- C51#	0	4.13	1	800	P
NCT23027001- IMR18650T12- C52#	0	4.14	1	800	P
NCT23027001- IMR18650T12- C53#	0	4.13	1	800	P
Model: IMR18650T16					
Samples charged at charging temperature upper limit (45°C)					
NCT23027001- IMR18650T16- C44#	45	4.20	1	800	P
NCT23027001- IMR18650T16- C45#	45	4.21	1	800	P
NCT23027001- IMR18650T16- C46#	45	4.21	1	800	P
NCT23027001- IMR18650T16- C47#	45	4.21	1	800	P
NCT23027001- IMR18650T16- C48#	45	4.20	1	800	P
Samples charged at charging temperature lower limit (0°C)					
NCT23027001- IMR18650T16- C49#	0	4.14	1	800	P
NCT23027001- IMR18650T16- C50#	0	4.13	1	800	P
NCT23027001- IMR18650T16- C51#	0	4.14	1	800	P
NCT23027001- IMR18650T16- C52#	0	4.13	1	800	P
NCT23027001- IMR18650T16- C53#	0	4.13	1	800	P
Model: IMR18650T18					
Samples charged at charging temperature upper limit (45°C)					

IEC 62133-2					
Clause	Requirement + Test			Result - Remark	Verdict
NCT23027001- IMR18650T18- C44#	45	4.20	1	800	P
NCT23027001- IMR18650T18- C45#	45	4.20	1	800	P
NCT23027001- IMR18650T18- C46#	45	4.21	1	800	P
NCT23027001- IMR18650T18- C47#	45	4.21	1	800	P
NCT23027001- IMR18650T18- C48#	45	4.20	1	800	P
Samples charged at charging temperature lower limit (0°C)					
NCT23027001- IMR18650T18- C49#	0	4.13	1	800	P
NCT23027001- IMR18650T18- C50#	0	4.13	1	800	P
NCT23027001- IMR18650T18- C51#	0	4.14	1	800	P
NCT23027001- IMR18650T18- C52#	0	4.13	1	800	P
NCT23027001- IMR18650T18- C53#	0	4.14	1	800	P
Model: INR18650L22					
Samples charged at charging temperature upper limit (45°C)					
NCT23027001- INR18650L22- C44#	45	4.20	1	800	P
NCT23027001- INR18650L22- C45#	45	4.19	1	800	P
NCT23027001- INR18650L22- C46#	45	4.20	1	800	P
NCT23027001- INR18650L22- C47#	45	4.19	1	800	P

IEC 62133-2					
Clause	Requirement + Test			Result - Remark	Verdict
NCT23027001- INR18650L22- C48#	45	4.20	1	800	P
Samples charged at charging temperature lower limit (0°C)					
NCT23027001- INR18650L22- C49#	0	4.13	1	800	P
NCT23027001- INR18650L22- C50#	0	4.14	1	800	P
NCT23027001- INR18650L22- C51#	0	4.13	1	800	P
NCT23027001- INR18650L22- C52#	0	4.14	1	800	P
NCT23027001- INR18650L22- C53#	0	4.14	1	800	P
Model: INR18650L26					
Samples charged at charging temperature upper limit (45°C)					
NCT23027001- INR18650L26- C44#	45	4.20	1	800	P
NCT23027001- INR18650L26- C45#	45	4.20	1	800	P
NCT23027001- INR18650L26- C46#	45	4.21	1	800	P
NCT23027001- INR18650L26- C47#	45	4.20	1	800	P
NCT23027001- INR18650L26- C48#	45	4.21	1	800	P
Samples charged at charging temperature lower limit (0°C)					
NCT23027001- INR18650L26- C49#	0	4.13	1	800	P
NCT23027001- INR18650L26- C50#	0	4.13	1	800	P
NCT23027001- INR18650L26-	0	4.14	1	800	P

IEC 62133-2					
Clause	Requirement + Test			Result - Remark	Verdict
C51#					
NCT23027001- INR18650L26- C52#	0	4.14	1	800	P
NCT23027001- INR18650L26- C53#	0	4.13	1	800	P
Model: INR18650L32					
Samples charged at charging temperature upper limit (45°C)					
NCT23027001- INR18650L32- C44#	45	4.20	1	800	P
NCT23027001- INR18650L32- C45#	45	4.21	1	800	P
NCT23027001- INR18650L32- C46#	45	4.21	1	800	P
NCT23027001- INR18650L32- C47#	45	4.20	1	800	P
NCT23027001- INR18650L32- C48#	45	4.20	1	800	P
Samples charged at charging temperature lower limit (0°C)					
NCT23027001- INR18650L32- C49#	0	4.13	1	800	P
NCT23027001- INR18650L32- C50#	0	4.14	1	800	P
NCT23027001- INR18650L32- C51#	0	4.13	1	800	P
NCT23027001- INR18650L32- C52#	0	4.14	1	800	P
NCT23027001- INR18650L32- C53#	0	4.13	1	800	P
Supplementary information:					
1) Identify one of the following:					
1: Nickel particle inserted between positive and negative (active material) coated area.					
2: Nickel particle inserted between positive aluminium foil and negative active material coated area.					
- No fire					

IEC 62133-2			
Clause	Requirement + Test	Result - Remark	Verdict

D.2	TABLE: Internal AC resistance for coin cells			N/A
Sample no.	Ambient T (°C)	Store time (h)	Resistance Rac (Ω)	Results ¹⁾
Supplementary information:				

IEC 62133-2			
Clause	Requirement + Test	Result - Remark	Verdict

TABLE: Critical components information					P
Object / part No.	Manufacturer/ trademark	Type / model	Technical data	Standard	Mark(s) of conformity ¹⁾
-Positive electrode		230µm	LiNi _x Co _y Mn _{1-x-y} O ₂ , LiMnO ₂ , Ni: Co: Mn=8: 1: 1, CNT, SP, NMP, Aluminum foil	--	--
-Negative electrode		200µm	CMC, SBR, NMP, H ₂ O, SP, Graphite, Copper foil	--	--
-Separator	Shenzhen Wandefu New Energy Technology Co. , Ltd.	One-sided ceramic	PE+Ceramic, Width: 61mm, Thickness: 11.5±1.5µm, Shutdown temperature: 130°C	--	--
-Electrolyte	Xiamen Shouneng Technology Co., Ltd	TKT01	Ethylene carbonate, Diethyl carbonate, Lithium hexafluorophosphate	--	--
-PTC	Huizhou JuDing Electronics Co Ltd	JD-D1	Ih: 3.5A, It: 7A, Vmax 15Vdc, Imax: 40A, Tmoa: 70°C	UL 1434	UL E482764
Supplementary information: 1) Provided evidence ensures the agreed level of compliance. See OD-CB2039. License available upon request.					

-- End of Report --

IEC62133_2B ATTACHMENT			
Clause	Requirement + Test	Result - Remark	Verdict
ATTACHMENT TO TEST REPORT IEC 62133-2 (Republic of Korea) NATIONAL DIFFERENCES (Secondary cells and batteries containing alkaline or other non-acid electrolytes - Safety requirements for portable sealed secondary lithium cells, and for batteries made from them, for use in portable applications - Part 2: Lithium systems)			
Differences according to..... : National standard KC62133-2(2020-07)			
TRF template used:..... : IECEE OD-2020-F3, Ed. 1.1			
Attachment Form No. : KR_ND_IEC62133_2B			
Attachment Originator..... : KTR			
Master Attachment..... : Dated 2022-05-27			
Copyright © 2020 IEC System for Conformity Testing and Certification of Electrical Equipment (IECEE), Geneva, Switzerland. All rights reserved.			
	National Differences		P
7.3.6	Over-charging of battery		N/A
(Revision)	<p>[Add the bolded text]</p> <p>b) Test</p> <p>The test shall be carried out in an ambient temperature of 20 °C ± 5 °C. Each test battery shall be discharged at a constant current of 0,2 It A, to a final discharge voltage specified by the manufacturer. Sample batteries shall then be charged at a constant current of 2,0 It A, using a supply voltage which is:</p> <ul style="list-style-type: none"> • 1,4 times the upper limit charging voltage presented in Table A.1 (but not to exceed 6,0 V) for single cell/cell block batteries or • 1,2 times the upper limit charging voltage presented in Table A.1 per cell for series connected multi-cell batteries, and • sufficient to maintain a current of 2,0 It A throughout the duration of the test or until the supply voltage is reached. <p><u>• In case the charging voltage specified by the manufacturer is higher than the overcharge test voltage, the maximum charging voltage specified by manufacturer should be applied with 2.0 ItA,</u></p> <p><u>(e.g., quick charging power bank, etc.)</u></p>	Cell only.	N/A

IEC62133_2B ATTACHMENT			
Clause	Requirement + Test	Result - Remark	Verdict
	<p>[Replace to the following statement]</p> <p>c) Acceptance criteria Filling beyond the manufacturer's specified limits should not result in ignition or explosion</p>		N/A
Annex G	Definition for shape and materials of outer case for cell		—
<i>(Addition)</i>	<p>G.1 General Annex G provides definitions for shape and materials of outer case for cell</p> <p>G.2 Shape of outer case for cell G 2.1 Cylindrical cell Cell with a cylindrical shape in which the overall height is equal to or greater than diameter.</p> <p>G 2.2 Prismatic cell Cell having the shape of a parallelepiped whose faces are rectangular</p> <p>G.3 Materials of outer case for cell G.3.1 Soft case Non-metallic outer case or container for cell</p> <p>G.3.2 Hard case Metallic outer case or container for cell.</p>	<p>(Shape of outer cases) <input checked="" type="checkbox"/> Cylindrical <input type="checkbox"/> Prismatic</p> <p>(Materials of outer cases) <input checked="" type="checkbox"/> Hard <input type="checkbox"/> Soft</p>	—
Annex H	Calculation method of the volumetric energy density for cell		—

IEC62133_2B ATTACHMENT			
Clause	Requirement + Test	Result - Remark	Verdict
(Addition)	<p>Annex H provide a calculation method of the volumetric energy density for cell in use of smart phone, tablet, notebook.</p> <p>H.1 General</p> <p>Unless otherwise stated in the Annex E, the dimensions for calculation are based on these for cell before shipment and the volumetric energy density shall be calculated with a maximum values specified by manufacturer. If the specification for cell can't be provided a dimension for calculation, the manufacturer's other documentation shall be provided to demonstrate compliance for its calculation.</p>	<p>IMR18650T12: 250.2Wh / L</p> <p>IMR18650T16: 333.7Wh / L</p> <p>IMR18650T18: 375.4Wh / L</p> <p>IMR18650L18: 375.4Wh / L</p> <p>INR18650T20: 417.1Wh / L</p> <p>INR18650L20: 417.1Wh / L</p> <p>INR18650T22: 458.8Wh / L</p> <p>INR18650L22: 458.8Wh / L</p> <p>INR18650T25: 521.3Wh / L</p> <p>INR18650L25: 521.3Wh / L</p> <p>INR18650T26: 542.2Wh / L</p> <p>INR18650L26: 542.2Wh / L</p> <p>INR18650L30: 625.6Wh / L</p> <p>INR18650L32: 667.3Wh / L</p>	—

IEC62133_2B ATTACHMENT			
Clause	Requirement + Test	Result - Remark	Verdict
	<p>H.2 Calculation Method</p> <p>L : Length (max.) of cell (including terrace) W : Width (max.) of cell T : Thickness (max.) when shipping charge (For reference, Please Exclude the dimension of any tape that is attached to cell)</p> $\text{Volumetric energy density (Wh/L)} = \frac{\text{Nominal voltage (V)} \times \text{Rated capacity (Ah)}}{\text{Length (L)} \times \text{Width (W)} \times \text{Thickness (T)}}$ <p>[H.1 – Prismatic cell using soft case]</p> <p>L : Length (max.) of cell W : Width (max.) of cell T : Thickness when shipping charge (For reference, Please Exclude the dimension of any tape that is attached to cell)</p> $\text{Volumetric energy density (Wh/L)} = \frac{\text{Nominal voltage (V)} \times \text{Rated capacity (Ah)}}{\text{Length (L)} \times \text{Width (W)} \times \text{Thickness (T)}}$ <p>[H.2 – Prismatic cell using hard case]</p> <p>D : Diameter (max.) of cell L : Length (max.) of cell (According to shape of cell at shipping, The dimension of tube for cell may be included in overall dimension of cell)</p> $\text{Volumetric energy density (Wh/L)} = \frac{\text{Nominal voltage (V)} \times \text{Rated capacity (Ah)}}{3.14159 \times \frac{\text{Diameter (D)}^2}{4} \times \text{Length(L)}}$ <p>[H.3 – Cylindrical cell using hard case]</p>		—

Product: Lithium-ion Cell

Type Designation: **IMR18650T12, IMR18650T16, IMR18650T18, IMR18650L18, INR18650T20, INR18650L20, INR18650T22, INR18650L22, INR18650T25, INR18650L25, INR18650T26, INR18650L26, INR18650L30, INR18650L32**

Remark: The tested models **IMR18650T12, IMR18650T16, IMR18650T18, INR18650L22, INR18650L26, INR18650L32** are representatives of all models.

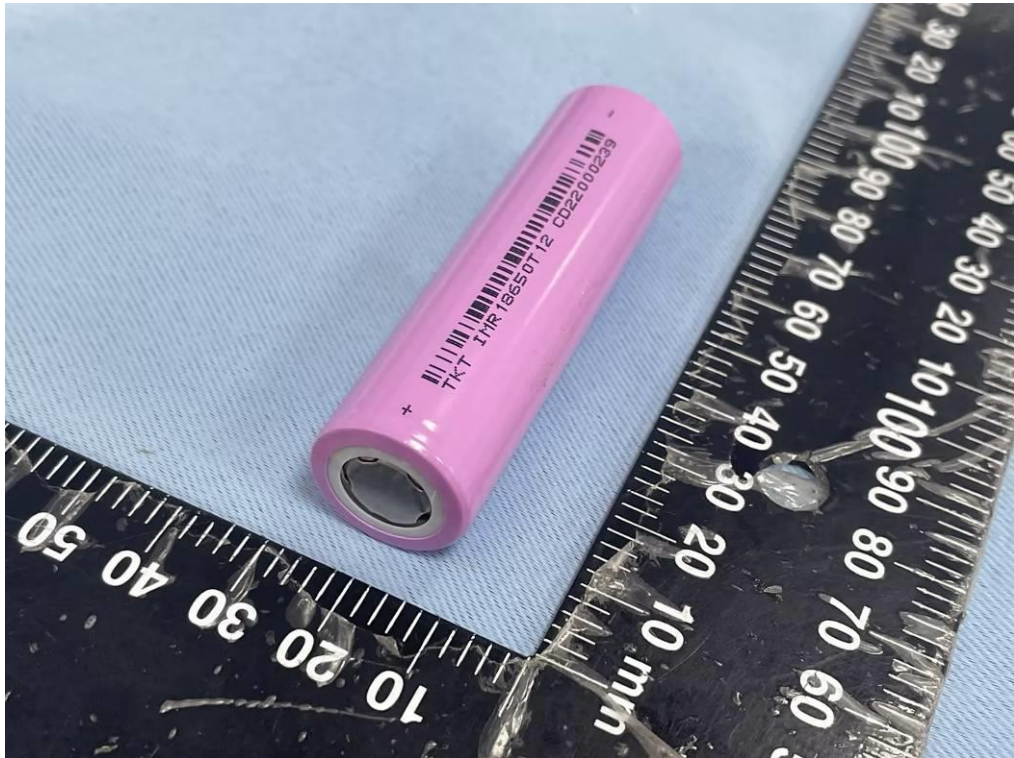

Picture 1 Top view of cell (Model: IMR18650T12)

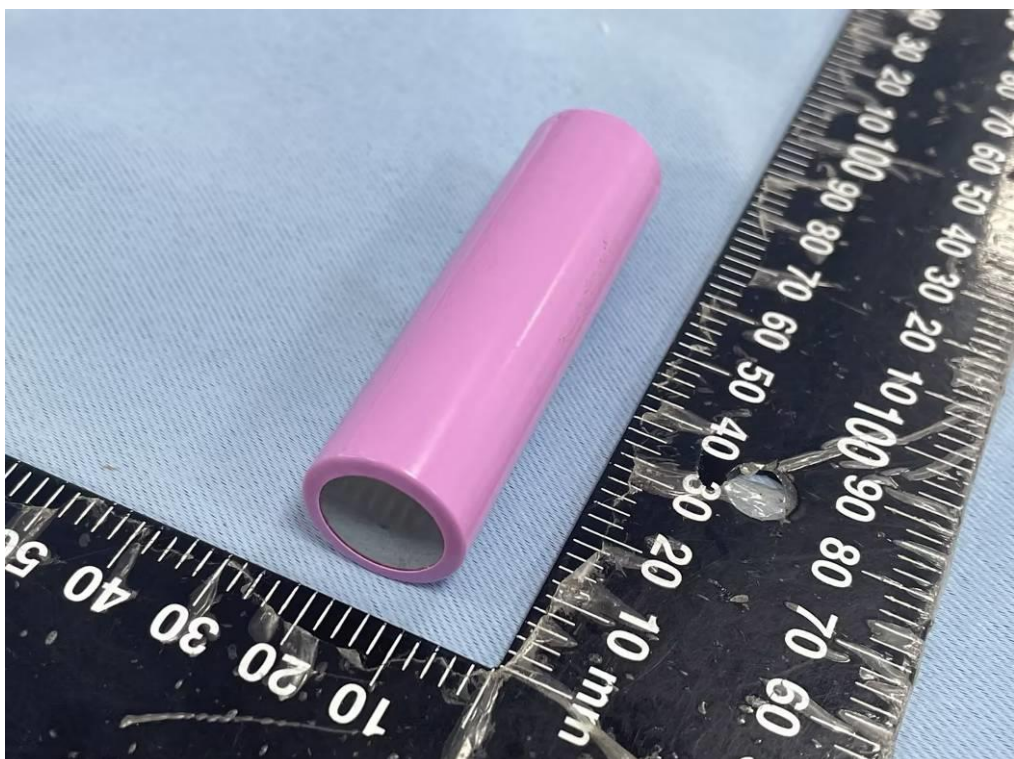

Picture 2 Bottom view of cell (Model: IMR18650T12)

Product: Lithium-ion Cell

Type Designation: **IMR18650T12, IMR18650T16, IMR18650T18, IMR18650L18, INR18650T20, INR18650L20, INR18650T22, INR18650L22, INR18650T25, INR18650L25, INR18650T26, INR18650L26, INR18650L30, INR18650L32**

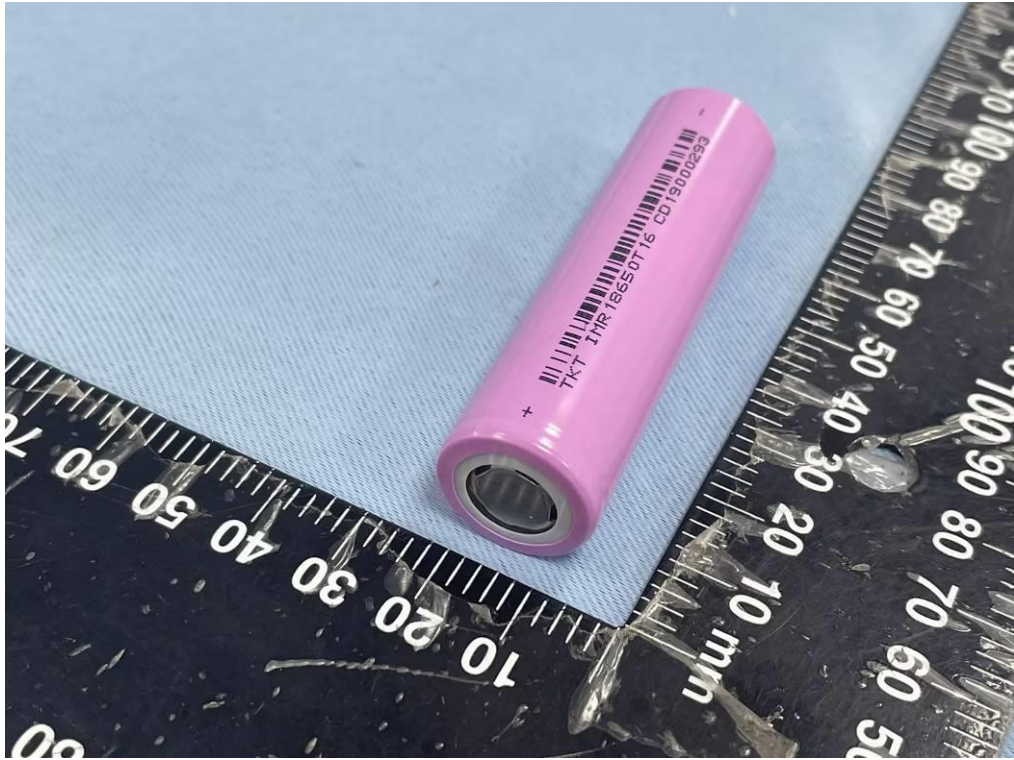

Picture 3 Top view of cell (Model: IMR18650T16)

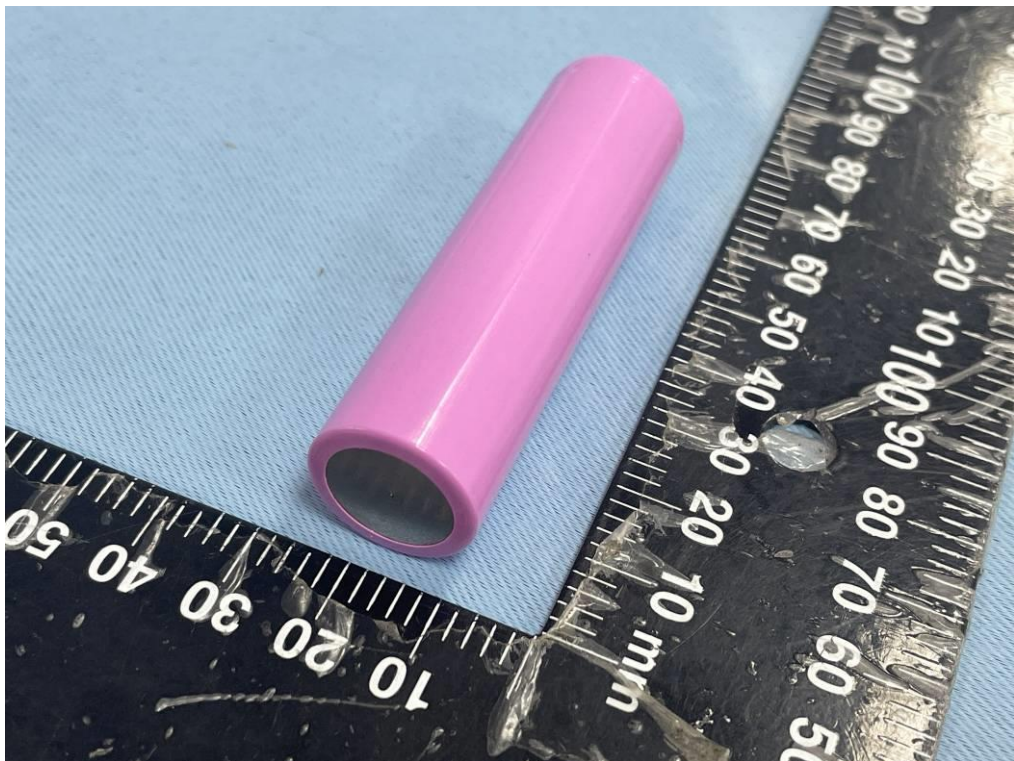

Picture 4 Bottom view of cell (Model: IMR18650T16)

Product: Lithium-ion Cell

Type Designation: **IMR18650T12, IMR18650T16, IMR18650T18, IMR18650L18, INR18650T20, INR18650L20, INR18650T22, INR18650L22, INR18650T25, INR18650L25, INR18650T26, INR18650L26, INR18650L30, INR18650L32**

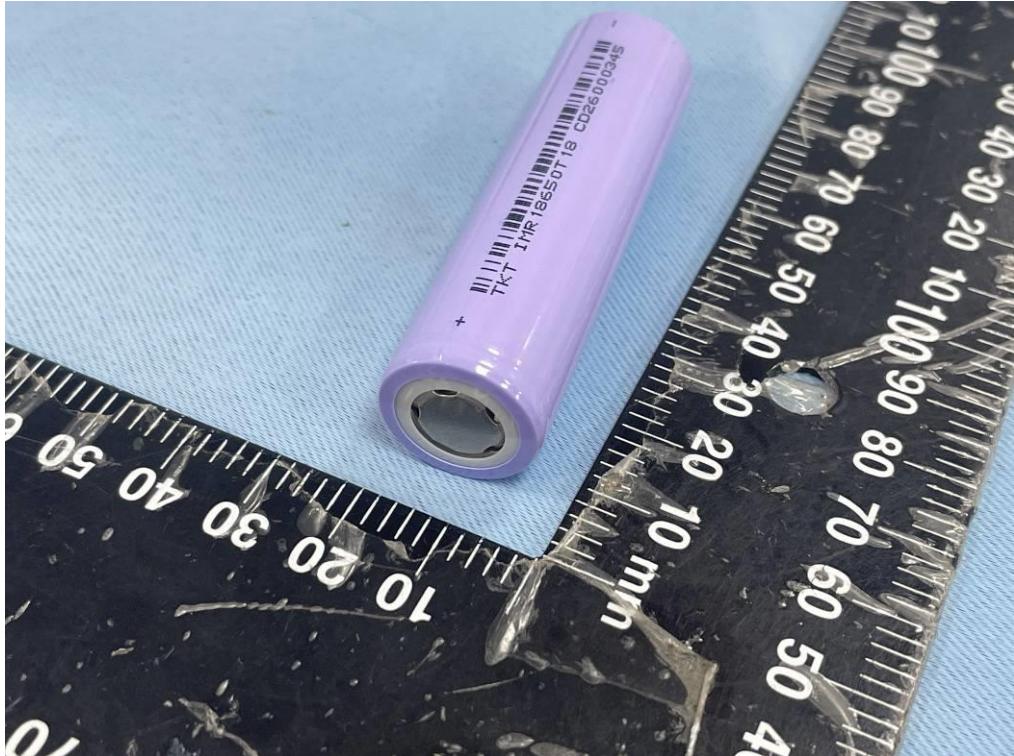

Picture 5 Top view of cell (Model: IMR18650T18)

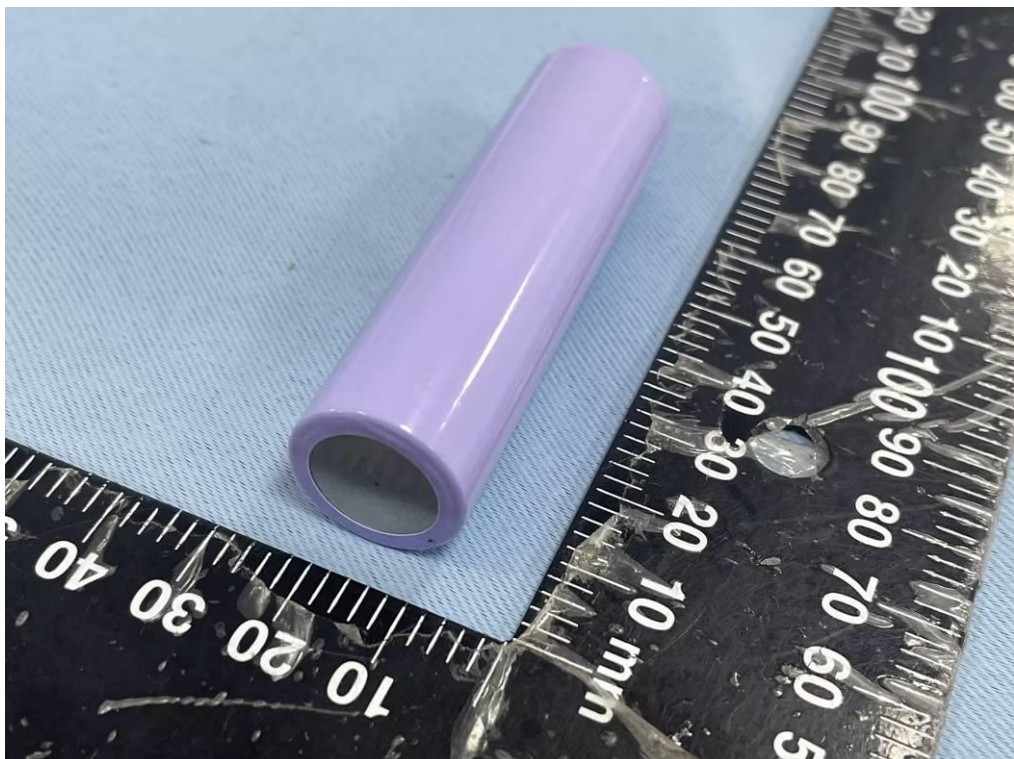

Picture 6 Bottom view of cell (Model: IMR18650T18)

Product: Lithium-ion Cell

Type Designation: **IMR18650T12, IMR18650T16, IMR18650T18, IMR18650L18, INR18650T20, INR18650L20, INR18650T22, INR18650L22, INR18650T25, INR18650L25, INR18650T26, INR18650L26, INR18650L30, INR18650L32**

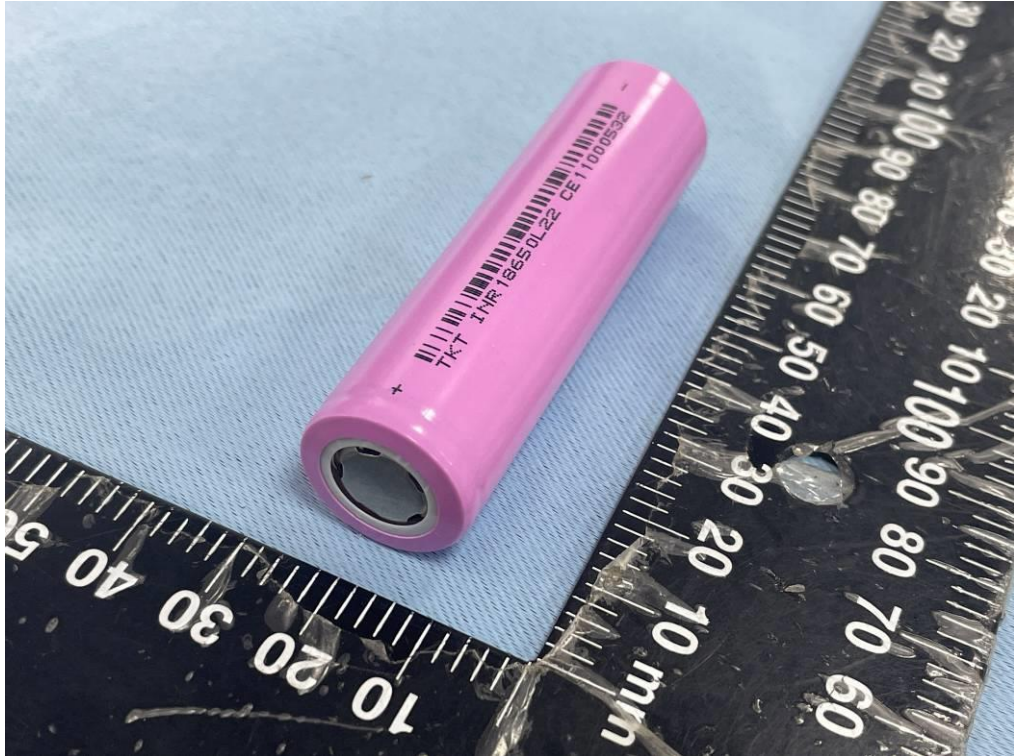

Picture 7 Top view of cell (Model: INR18650L22)

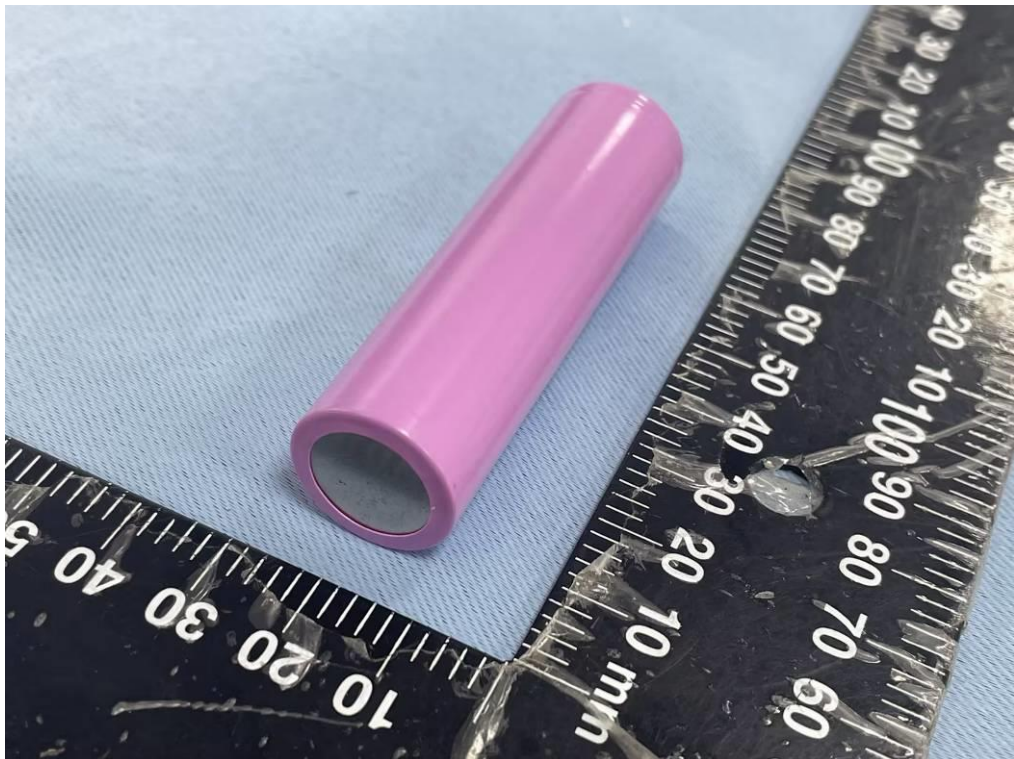

Picture 8 Bottom view of cell (Model: INR18650L22)

Product: Lithium-ion Cell

Type Designation: **IMR18650T12, IMR18650T16, IMR18650T18, IMR18650L18, INR18650T20, INR18650L20, INR18650T22, INR18650L22, INR18650T25, INR18650L25, INR18650T26, INR18650L26, INR18650L30, INR18650L32**

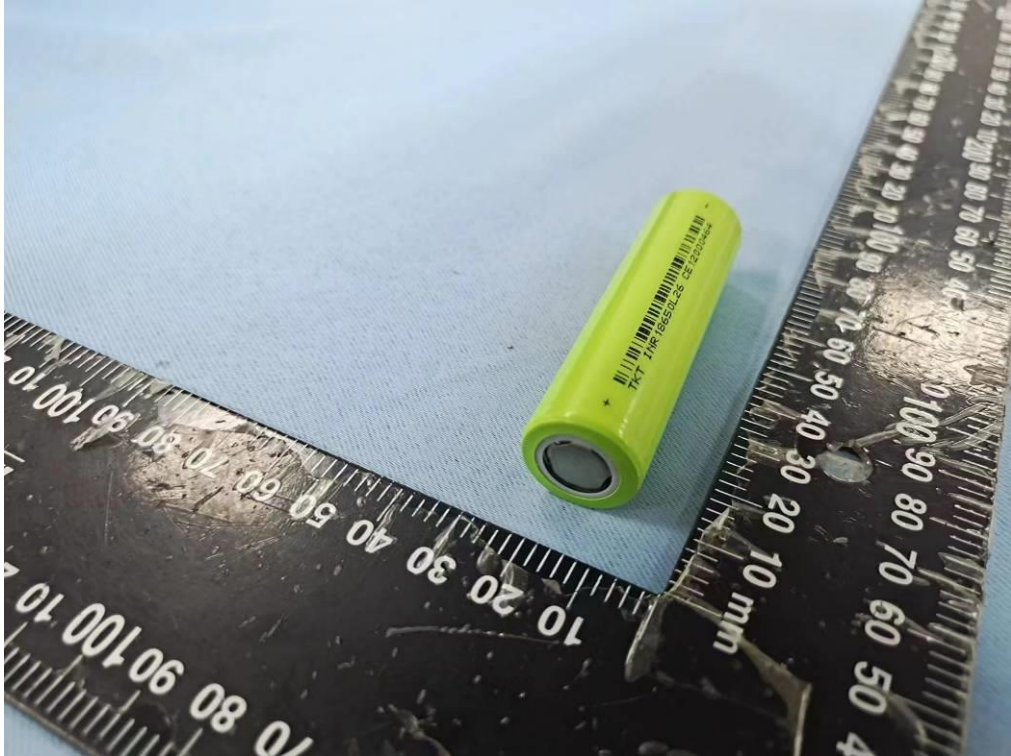

Picture 9 Top view of cell (Model: INR18650L26)



Picture 10 Bottom view of cell (Model: INR18650L26)

Product: Lithium-ion Cell

Type Designation: **IMR18650T12, IMR18650T16, IMR18650T18, IMR18650L18, INR18650T20, INR18650L20, INR18650T22, INR18650L22, INR18650T25, INR18650L25, INR18650T26, INR18650L26, INR18650L30, INR18650L32**

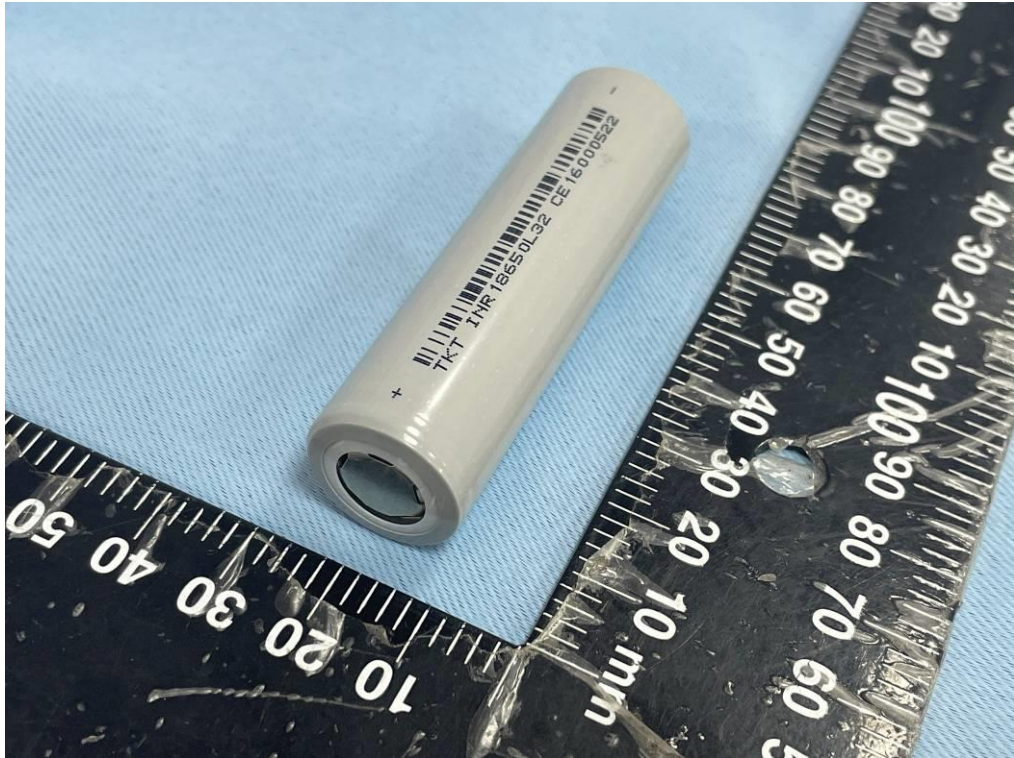

Picture 11 Top view of cell (Model: INR18650L32)

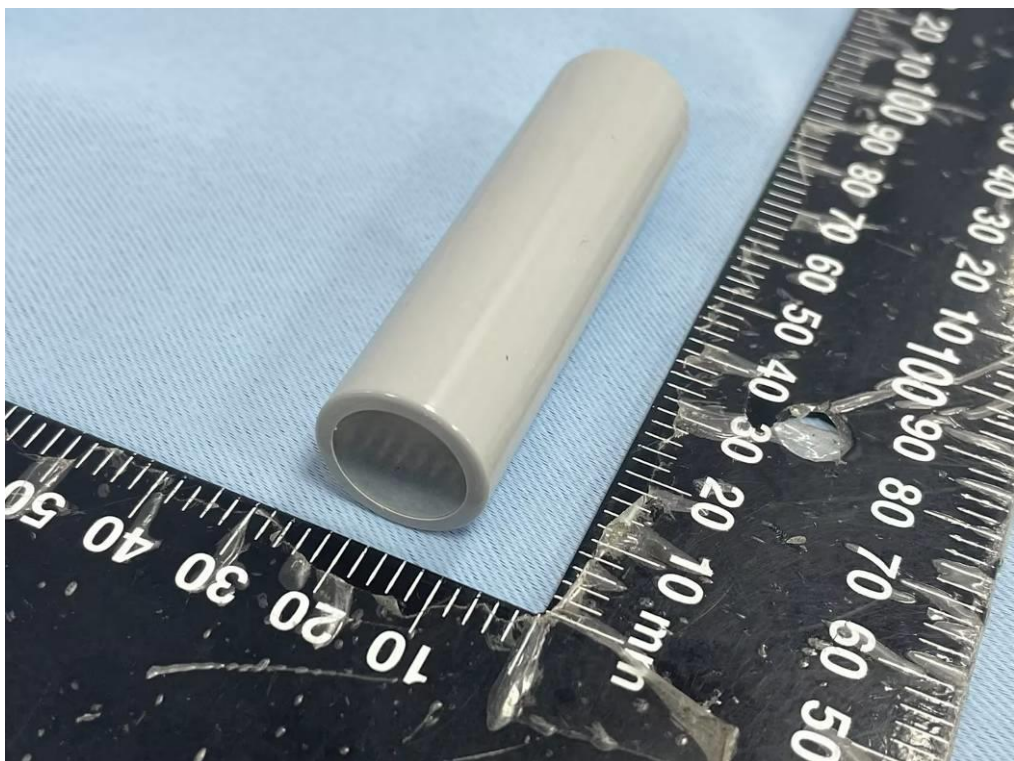

Picture 12 Bottom view of cell (Model: INR18650L32)