

---

# Safety Test Report

---

Report No.: AGC05443230405ES01

**PRODUCT DESIGNATION** : TWS earbuds with charging base  
**BRAND NAME** : N/A  
**MODEL NAME** : M06128, M06780  
**APPLICANT** : MID OCEAN BRANDS B.V  
**DATE OF ISSUE** : Jul. 04, 2023  
**STANDARD(S)** : EN IEC 62368-1:2020+A11:2020  
**REPORT VERSION** : V1.0



Attestation of Global Compliance (Shenzhen) Co., Ltd.

Any report having not been signed by authorized approver, or having been altered without authorization, or having not been stamped by the "Dedicated Testing/Inspection Stamp" is deemed to be invalid. Copying or excerpting portion of, or altering the content of the report is not permitted without the written authorization of AGC. The test results presented in the report apply only to the tested sample. Any objections to report issued by AGC should be submitted to AGC within 15days after the issuance of the test report. Further enquiry of validity or verification of the test report should be addressed to AGC by [agc01@agccert.com](mailto:agc01@agccert.com).

Attestation of Global Compliance(Shenzhen)Co., Ltd  
Attestation of Global Compliance(Shenzhen)Std & Tech Co., Ltd  
Tel: +86-755 2523 4088 E-mail: [agc@agccert.com](mailto:agc@agccert.com) Web: <http://www.agccert.com/>



<p><b>TEST REPORT</b></p> <p><b>EN IEC 62368-1</b></p> <p><b>Audio/video, information and communication technology equipment</b></p> <p><b>Part 1: Safety requirements</b></p>	
Report Number.....	AGC05443230405ES01
Tested by (+ signature).....	Fred Liang <span style="float: right;"><i>Fred Liang</i></span>
Reviewed by (+ signature).....	Byron Wang <span style="float: right;"><i>Byron Wang</i></span>
Approved by (+ signature).....	Matte He (Authorized Officer) <span style="float: right;"><i>Matte He</i></span>
Date of issue.....	Jul. 04, 2023
Total number of pages.....	Total 77 pages
<b>Testing laboratory</b>	
Name.....	Attestation of Global Compliance (Shenzhen) Co., Ltd.
Address.....	1-2/F, Building 19, Junfeng Industrial Park, Chongqing Road, Heping Community, Fuhai Street, Bao'an District, Shenzhen, Guangdong, China
Testing location.....	Same as above.
<b>Applicant</b>	
Name.....	MID OCEAN BRANDS B.V
Address.....	7/F, Kings Tower, 111 King Lam Street, Cheung Sha Wan, Kowloon, Hong Kong.
<b>Manufacturer</b>	
Name.....	MID OCEAN BRANDS B.V
Address.....	7/F, Kings Tower, 111 King Lam Street, Cheung Sha Wan, Kowloon, Hong Kong.
<b>Factory</b>	
Name.....	MID OCEAN BRANDS B.V
Address.....	7/F, Kings Tower, 111 King Lam Street, Cheung Sha Wan, Kowloon, Hong Kong.
<b>Test specification:</b>	
Standard.....	EN IEC 62368-1:2020+A11:2020
Test procedure.....	Type test
Procedure deviation.....	N/A
Non-standard test method.....	N/A

Any report having not been signed by authorized approver, or having been altered without authorization, or having not been stamped by the "Dedicated Testing/Inspection Stamp" is deemed to be invalid. Copying or excerpting portion of, or altering the content of the report is not permitted without the written authorization of AGC. The test results presented in the report apply only to the tested sample. Any objections to report issued by AGC should be submitted to AGC within 15days after the issuance of the test report. Further enquiry of validity or verification of the test report should be addressed to AGC by agc01@agccert.com.

<b>Test Report Form/blank test report</b>	
Test Report Form No..... : AGC62368A3	
TRF originator..... : AGC	
Master TRF..... : 2020-07	
<b>Test item</b>	
Test item description..... : TWS earbuds with charging base	
Trade Mark..... : N/A	
Test model..... : MO6128	
Series model..... : MO6780	
Ratings..... : 5V== 185mA (for charging base)	
<b>Test item particulars</b>	
Product group .....	<input checked="" type="checkbox"/> end product <input type="checkbox"/> built-in component
Classification of use by.....	<input checked="" type="checkbox"/> Ordinary person <input type="checkbox"/> Children likely present <input checked="" type="checkbox"/> Instructed person <input checked="" type="checkbox"/> Skilled person
Supply connection.....	<input type="checkbox"/> AC mains <input type="checkbox"/> DC mains <input checked="" type="checkbox"/> not mains connected: <input checked="" type="checkbox"/> ES1 <input type="checkbox"/> ES2 <input type="checkbox"/> ES3
Supply tolerance .....	<input type="checkbox"/> +10%/-10% <input type="checkbox"/> +20%/-15% <input type="checkbox"/> +    %/ -    % <input checked="" type="checkbox"/> None
Supply connection – type .....	<input type="checkbox"/> pluggable equipment type A - <input type="checkbox"/> non-detachable supply cord <input type="checkbox"/> appliance coupler <input type="checkbox"/> direct plug-in <input type="checkbox"/> pluggable equipment type B - <input type="checkbox"/> non-detachable supply cord <input type="checkbox"/> appliance coupler <input type="checkbox"/> permanent connection <input type="checkbox"/> mating connector <input checked="" type="checkbox"/> other: <u>not mains connected</u>
Considered current rating of protective device.....	<input type="checkbox"/> 16 A; Location: <input type="checkbox"/> building <input type="checkbox"/> equipment <input checked="" type="checkbox"/> N/A
Equipment mobility.....	<input checked="" type="checkbox"/> movable <input type="checkbox"/> hand-held <input checked="" type="checkbox"/> transportable <input type="checkbox"/> direct plug-in <input type="checkbox"/> stationary <input type="checkbox"/> for building-in <input type="checkbox"/> wall/ceiling-mounted <input type="checkbox"/> SRME/rack-mounted <input type="checkbox"/> other:
Overvoltage category (OVC) .....	<input type="checkbox"/> OVC I <input type="checkbox"/> OVC II <input type="checkbox"/> OVC III <input type="checkbox"/> OVC IV <input checked="" type="checkbox"/> other: <u>not mains connected</u>
Class of equipment .....	<input type="checkbox"/> Class I <input type="checkbox"/> Class II <input checked="" type="checkbox"/> Class III <input type="checkbox"/> Not classified <input type="checkbox"/>

Any report having not been signed by authorized approver, or having been altered without authorization, or having not been stamped by the "Dedicated Testing/Inspection Stamp" is deemed to be invalid. Copying or excerpting portion of, or altering the content of the report is not permitted without the written authorization of AGC. The test results presented in the report apply only to the tested sample. Any objections to report issued by AGC should be submitted to AGC within 15days after the issuance of the test report. Further enquiry of validity or verification of the test report should be addressed to AGC by agc01@agccert.com.

Special installation location .....	<input checked="" type="checkbox"/> N/A	<input type="checkbox"/> restricted access area		
	<input type="checkbox"/> outdoor location	<input type="checkbox"/>		
Pollution degree (PD) .....	<input type="checkbox"/> PD 1	<input checked="" type="checkbox"/> PD 2	<input type="checkbox"/> PD 3	
Manufacturer's specified T <sub>ma</sub> .....	45°C			
IP protection class .....	<input checked="" type="checkbox"/> IPX0	<input type="checkbox"/> IP		
Power systems .....	<input type="checkbox"/> TN	<input type="checkbox"/> TT	<input type="checkbox"/> IT - V <sub>L-L</sub>	
	<input checked="" type="checkbox"/> not AC mains			
Altitude during operation (m) .....	<input checked="" type="checkbox"/> 2000 m or less	<input type="checkbox"/> m		
Altitude of test laboratory (m) .....	<input checked="" type="checkbox"/> 2000 m or less	<input type="checkbox"/> m		
Mass of equipment (kg) .....	<input checked="" type="checkbox"/> <1 kg			
<b>Possible test case verdicts:</b>				
- test case does not apply to the test object.....	N(/A)			
- test object does meet the requirement.....	P (Pass)			
- test object does not meet the requirement.....	F (Fail)			
<b>Testing:</b>				
Date of receipt of test item.....	Apr. 10, 2023			
Date (s) of performance of tests.....	Jun. 14, 2023 –Jun. 30, 2023			
<b>Attachments:</b>				
Attachment A.....	Photos of product			
<b>General remarks:</b>				
This report shall not be reproduced except in full without the written approval of the testing laboratory.				
The test results presented in this report relate only to the item tested.				
“(See remark #)” refers to a remark appended to the report.				
“(See appended table)” refers to a table appended to the report.				
Throughout this report a point is used as the decimal separator.				
<b>Report Revise Record:</b>				
Report Version	Revise Time	Issued Date	Valid Version	Notes
V1.0	/	Jul. 04, 2023	Valid	Initial release

Any report having not been signed by authorized approver, or having been altered without authorization, or having not been stamped by the “Dedicated Testing/Inspection Stamp” is deemed to be invalid. Copying or excerpting portion of, or altering the content of the report is not permitted without the written authorization of AGC. The test results presented in the report apply only to the tested sample. Any objections to report issued by AGC should be submitted to AGC within 15days after the issuance of the test report. Further enquiry of validity or verification of the test report should be addressed to AGC by agc01@agccert.com.

**General product information and other remarks:**

The product consists of charging base and Earphone. The charging base charged via Type-C port and uses for charging Earphone. The Earphone is supplied by Li-polymer battery. All tests have been considered to both of them, Which is considered a transportable apparatus, and for dry location used only.

Instructions and equipment marking related to safety is applied in the language that is acceptable in the country in which the equipment is to be sold.

The product was submitted and tested for use at the manufacturer’s recommended ambient temperature (Tma) of 45°C.

All are the same except outer shell, For the differences described above, the following are considered necessary:

Clause	Testing
T.2, T.3, T.4, T.5	Steady force test
T.7	Drop test
T.8	Stress relief test

**Summary of testing**

The product fulfils the requirements of EN IEC 62368-1:2020+A11:2020.

**Copy of marking plate:**



**Remark:**

- 1) The CE marking and WEEE symbol (if any) should be at least 5mm and 7mm respectively in height.
- 2) The markings and instructions are the minimum requirements required by safety standard. For final production samples, the additional markings which do not give rise to misunderstanding may be added.
- 3) As declared by the applicant, the importer (and manufacturer, if it is different)’s name, registered trade name or mark and the postal address will be marked on the products before being place on the market.
- 4) Marking on the packaging or in a document accompanying the electrical equipment is only acceptable if it is not possible to place such markings on the product.

Any report having not been signed by authorized approver, or having been altered without authorization, or having not been stamped by the “Dedicated Testing/Inspection Stamp” is deemed to be invalid. Copying or excerpting portion of, or altering the content of the report is not permitted without the written authorization of AGC. The test results presented in the report apply only to the tested sample. Any objections to report issued by AGC should be submitted to AGC within 15days after the issuance of the test report. Further enquiry of validity or verification of the test report should be addressed to AGC by agc01@agccert.com.

OVERVIEW OF ENERGY SOURCES AND SAFEGUARDS				
Clause	Possible Hazard			
5	Electrically-caused injury			
Class and Energy Source (e.g. ES3: Primary circuit)	Body Part (e.g. Ordinary)	Safeguards		
		B	S	R
ES1: All internal circuits	Ordinary person	N/A	N/A	N/A
6	Electrically-caused fire			
Class and Energy Source (e.g. PS2: 100 Watt circuit)	Material part (e.g. Printed board)	Safeguards		
		B	1 <sup>st</sup> S	2 <sup>nd</sup> S
PS2: Type-C supply port PS2: Internal circuits PS2: Battery cell(charging base) PS2: Battery pack(charging base) PS1: Battery cell (Earphone) PS1: Battery pack(Earphone)	All Flammable materials inside and plastic enclosure	1. No ignition occurred. 2. No parts exceeding 90% of its spontaneous ignition temperature.	1. PCB is complied with V-0 material; 2. all other components: at least V-2 except for mounted on min. V-1 material or small parts of combustible material	V-0 plastic enclosure used
7	Injury caused by hazardous substances			
Class and Energy Source (e.g. Ozone)	Body Part (e.g., Skilled)	Safeguards		
		B	S	R
Battery	Ordinary person	N/A	N/A	N/A
8	Mechanically-caused injury			
Class and Energy Source (e.g. MS3: Plastic fan blades)	Body Part (e.g. Ordinary)	Safeguards		
		B	S	R
MS1: Edges and corners	Ordinary person	N/A	N/A	N/A
MS1: Equipment mass	Ordinary person	N/A	N/A	N/A
9	Thermal burn			
Class and Energy Source (e.g. TS1: Keyboard caps)	Body Part (e.g., Ordinary)	Safeguards		
		B	S	R
TS1: Accessible enclosure	Ordinary person	N/A	N/A	N/A
10	Radiation			
Class and Energy Source (e.g. RS1: PMP sound output)	Body Part (e.g., Ordinary)	Safeguards		
		B	S	R
RS1: Indicator LED	Ordinary person	N/A	N/A	N/A
Acoustic (See Clause 10.6.5)	Ordinary person	N/A	N/A	N/A
Supplementary Information: "B" – Basic Safeguard; "S" – Supplementary Safeguard; "R" – Reinforced Safeguard				

Any report having not been signed by authorized approver, or having been altered without authorization, or having not been stamped by the "Dedicated Testing/Inspection Stamp" is deemed to be invalid. Copying or excerpting portion of, or altering the content of the report is not permitted without the written authorization of AGC. The test results presented in the report apply only to the tested sample. Any objections to report issued by AGC should be submitted to AGC within 15days after the issuance of the test report. Further enquiry of validity or verification of the test report should be addressed to AGC by agc01@agccert.com.

ENERGY SOURCE DIAGRAM

**Optional.** Manufacturers are to provide the energy sources diagram identify declared energy sources and identifying the demarcations are between power sources. Recommend diagram be provided included in power supply and multipart systems.

Insert diagram below. Example diagram designs are; Block diagrams; image(s) with layered data; mechanical drawings

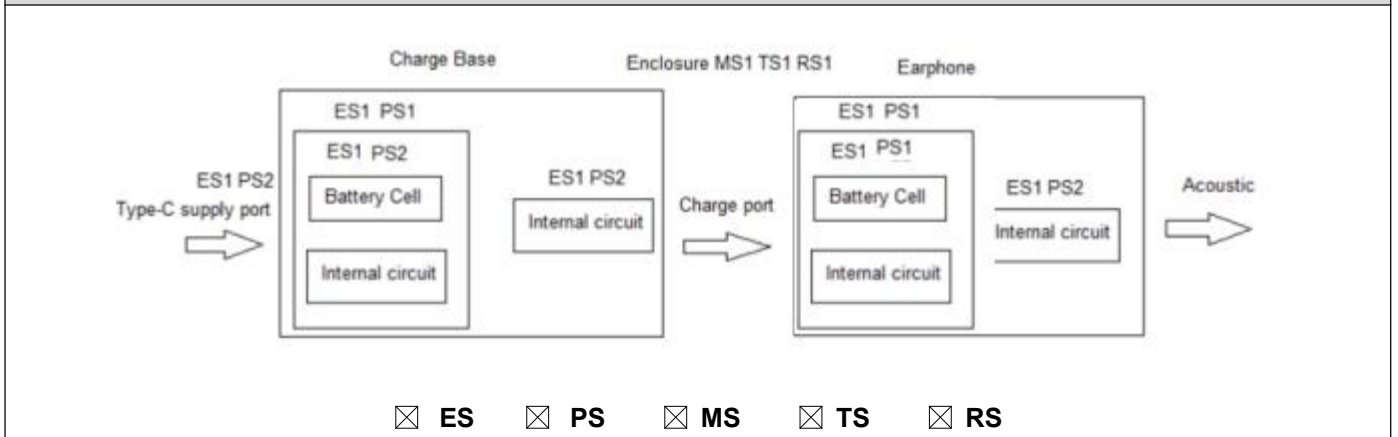

Any report having not been signed by authorized approver, or having been altered without authorization, or having not been stamped by the “Dedicated Testing/Inspection Stamp” is deemed to be invalid. Copying or excerpting portion of, or altering the content of the report is not permitted without the written authorization of AGC. The test results presented in the report apply only to the tested sample. Any objections to report issued by AGC should be submitted to AGC within 15days after the issuance of the test report. Further enquiry of validity or verification of the test report should be addressed to AGC by agc01@agccert.com.



EN IEC 62368-1			
Clause	Requirement + Test	Result - Remark	Verdict
<b>4</b>	<b>GENERAL REQUIREMENTS</b>		P
4.1.1	Acceptance of materials, components and subassemblies	See appended table 4.1.2	P
4.1.2	Use of components	Components which are certified to IEC and/or national standards are used correctly within their ratings. Components not covered by IEC standards are tested under the conditions present in the equipment.	P
4.1.3	Equipment design and construction	No accessible part which could cause injury	P
4.1.4	Specified ambient temperature for outdoor use (°C)..... :		N
4.1.5	Constructions and components not specifically covered	No such parts.	N
4.1.8	Liquids and liquid filled components (LFC)	No such parts.	N
4.1.15	Markings and instructions	(See Annex F)	P
4.4.3	Safeguard robustness		P
4.4.3.1	General		P
4.4.3.2	Steady force tests	(See Annex T.4)	P
4.4.3.3	Drop tests	(See Annex T.7)	P
4.4.3.4	Impact tests		N
4.4.3.5	Internal accessible safeguard tests		N
4.4.3.6	Glass impact tests		N
4.4.3.7	Glass fixation tests		N
	Glass impact test (1J)		N
	Push/pull test (10 N)		N
4.4.3.8	Thermoplastic material tests	(See Annex T.8)	P
4.4.3.9	Air comprising a safeguard		N
4.4.3.10	Accessibility, glass, safeguard effectiveness	Safeguard remain effective.	P
4.4.4	Displacement of a safeguard by an insulating liquid		N
4.4.5	Safety interlocks	No such component within equipment.	N
<b>4.5</b>	<b>Explosion</b>		P
4.5.1	General	No explosion occurs during normal/abnormal operation and	P

Any report having not been signed by authorized approver, or having been altered without authorization, or having not been stamped by the "Dedicated Testing/Inspection Stamp" is deemed to be invalid. Copying or excerpting portion of, or altering the content of the report is not permitted without the written authorization of AGC. The test results presented in the report apply only to the tested sample. Any objections to report issued by AGC should be submitted to AGC within 15days after the issuance of the test report. Further enquiry of validity or verification of the test report should be addressed to AGC by agc01@agccert.com.



EN IEC 62368-1			
Clause	Requirement + Test	Result - Remark	Verdict
		single fault conditions	
4.5.2	No explosion during normal/abnormal operating condition	(See Clause B.2, B.3)	P
	No harm by explosion during single fault conditions	(See Clause B.4)	P
<b>4.6</b>	<b>Fixing of conductors</b>		N
	Fix conductors not to defeat a safeguard	Not defeat a safeguard.	N
	Compliance is checked by test..... :		N
<b>4.7</b>	<b>Equipment for direct insertion into mains socket-outlets</b>		N
4.7.2	Mains plug part complies with relevant standard.. :		N
4.7.3	Torque (Nm)..... :		N
<b>4.8</b>	<b>Equipment containing coin/button cell batteries</b>		N
4.8.1	General	No coin/button cell is used	N
4.8.2	Instructional safeguard..... :		N
4.8.3	Battery compartment door/cover construction		N
	Open torque test		N
4.8.4.2	Stress relief test		N
4.8.4.3	Battery replacement test		N
4.8.4.4	Drop test		N
4.8.4.5	Impact test		N
4.8.4.6	Crush test		N
4.8.5	Compliance		N
	30N force test with test probe		N
	20N force test with test hook		N
<b>4.9</b>	<b>Likelihood of fire or shock due to entry of conductive object</b>		N
<b>4.10</b>	<b>Component requirements</b>		N
4.10.1	Disconnect Device		N
4.10.2	Switches and relays		N
<b>5</b>	<b>ELECTRICALLY-CAUSED INJURY</b>		P
<b>5.2</b>	<b>Classification and limits of electrical energy sources</b>		P
5.2.2	ES1, ES2 and ES3 limits	(See appended table 5.2)	P
5.2.2.2	Steady-state voltage and current limits..... :	ES1	P
5.2.2.3	Capacitance limits..... :		N
5.2.2.4	Single pulse limits..... :	No such single pulses with the EUT	N

Any report having not been signed by authorized approver, or having been altered without authorization, or having not been stamped by the "Dedicated Testing/Inspection Stamp" is deemed to be invalid. Copying or excerpting portion of, or altering the content of the report is not permitted without the written authorization of AGC. The test results presented in the report apply only to the tested sample. Any objections to report issued by AGC should be submitted to AGC within 15days after the issuance of the test report. Further enquiry of validity or verification of the test report should be addressed to AGC by agc01@agccert.com.

EN IEC 62368-1			
Clause	Requirement + Test	Result - Remark	Verdict
5.2.2.5	Limits for repetitive pulses.....	No such repetitive pulses with the EUT	N
5.2.2.6	Ringing signals	No such ringing signals with the EUT	N
5.2.2.7	Audio signals	Internal speakers and supplied by ES1 circuit only.	N
<b>5.3</b>	<b>Protection against electrical energy sources</b>		N
5.3.1	General Requirements for accessible parts to ordinary, instructed and skilled persons	ES1	N
5.3.1 a)	Accessible ES1/ES2 derived from ES2/ES3 circuits		N
5.3.1 b)	Skilled persons not unintentional contact ES3 bare conductors		N
5.3.2.1	Accessibility to electrical energy sources and safeguards		N
	Accessibility to outdoor equipment bare parts		N
5.3.2.2	Contact requirements		N
	Test with test probe from Annex V		-
5.3.2.2 a)	Air gap – electric strength test potential (V).....		N
5.3.2.2 b)	Air gap – distance (mm) .....		N
5.3.2.3	Compliance		N
5.3.2.4	Terminals for connecting stripped wire		N
<b>5.4</b>	<b>Insulation materials and requirements</b>		N
5.4.1.2	Properties of insulating material		N
5.4.1.3	Material is non-hygroscopic		N
5.4.1.4	Maximum operating temperature for insulating materials.....		N
5.4.1.5	Pollution degrees.....		N
5.4.1.5.2	Test for pollution degree 1 environment and for an insulating compound		N
5.4.1.5.3	Thermal cycling test		N
5.4.1.6	Insulation in transformers with varying dimensions		N
5.4.1.7	Insulation in circuits generating starting pulses		N
5.4.1.8	Determination of working voltage.....		N
5.4.1.9	Insulating surfaces		N
5.4.1.10	Thermoplastic parts on which conductive metallic parts are directly mounted		N

Any report having not been signed by authorized approver, or having been altered without authorization, or having not been stamped by the “Dedicated Testing/Inspection Stamp” is deemed to be invalid. Copying or excerpting portion of, or altering the content of the report is not permitted without the written authorization of AGC. The test results presented in the report apply only to the tested sample. Any objections to report issued by AGC should be submitted to AGC within 15days after the issuance of the test report. Further enquiry of validity or verification of the test report should be addressed to AGC by agc01@agccert.com.

EN IEC 62368-1			
Clause	Requirement + Test	Result - Remark	Verdict
5.4.1.10.2	Vicat test.....		N
5.4.1.10.3	Ball pressure test.....		N
5.4.2	Clearances		N
5.4.2.1	General requirements		N
	Clearances in circuits connected to AC Mains, Alternative method		N
5.4.2.2	Procedure 1 for determining clearance		N
	Temporary overvoltage .....		—
5.4.2.3	Procedure 2 for determining clearance		N
5.4.2.3.2.2	a.c. mains transient voltage.....		—
5.4.2.3.2.3	d.c. mains transient voltage .....		—
5.4.2.3.2.4	External circuit transient voltage.....		—
5.4.2.3.2.5	Transient voltage determined by measurement.....		—
5.4.2.4	Determining the adequacy of a clearance using an electric strength test .....		N
5.4.2.5	Multiplication factors for clearances and test voltages.....		N
5.4.2.6	Clearance measurement.....		N
5.4.3	Creepage distances		N
5.4.3.1	General		N
5.4.3.3	Material group.....		—
5.4.3.4	Creepage distances measurement.....		N
5.4.4	Solid insulation		N
5.4.4.1	General requirements		N
5.4.4.2	Minimum distance through insulation .....		N
5.4.4.3	Insulating compound forming solid insulation		N
5.4.4.4	Solid insulation in semiconductor devices		N
5.4.4.5	Insulating compound forming cemented joints		N
5.4.4.6	Thin sheet material		N
5.4.4.6.1	General requirements		N
5.4.4.6.2	Separable thin sheet material		N
	Number of layers (pcs) .....		N
5.4.4.6.3	Non-separable thin sheet material		N
	Number of layers (pcs) .....		N

Any report having not been signed by authorized approver, or having been altered without authorization, or having not been stamped by the “Dedicated Testing/Inspection Stamp” is deemed to be invalid. Copying or excerpting portion of, or altering the content of the report is not permitted without the written authorization of AGC. The test results presented in the report apply only to the tested sample. Any objections to report issued by AGC should be submitted to AGC within 15days after the issuance of the test report. Further enquiry of validity or verification of the test report should be addressed to AGC by agc01@agccert.com.

EN IEC 62368-1			
Clause	Requirement + Test	Result - Remark	Verdict
5.4.4.6.4	Standard test procedure for non-separable thin sheet material.....		N
5.4.4.6.5	Mandrel test		N
5.4.4.7	Solid insulation in wound components		N
5.4.4.9	Solid insulation at frequencies >30 kHz, $E_P$ , $K_R$ , $d$ , $V_{PW}$ (V).....		N
	Alternative by electric strength test, tested voltage (V), $K_R$ .....		N
5.4.5	Antenna terminal insulation		N
5.4.5.1	General		N
5.4.5.2	Voltage surge test		N
5.4.5.3	Insulation resistance (M $\Omega$ ).....		N
	Electric strength test.....		N
5.4.6	Insulation of internal wire as part of supplementary safeguard		N
5.4.7	Tests for semiconductor components and for cemented joints		N
5.4.8	Humidity conditioning		N
	Relative humidity (%), temperature ( $^{\circ}$ C), duration (h).....		—
5.4.9	Electric strength test		N
5.4.9.1	Test procedure for type test of solid insulation.....		N
5.4.9.2	Test procedure for routine test		N
5.4.10	Safeguards against transient voltages from external circuits		N
5.4.10.1	Parts and circuits separated from external circuits		N
5.4.10.2	Test methods		N
5.4.10.2.1	General		N
5.4.10.2.2	Impulse test.....		N
5.4.10.2.3	Steady-state test.....		N
5.4.10.3	Verification for insulation breakdown for impulse test.....		N
5.4.11	Separation between external circuits and earth		N
5.4.11.1	Exceptions to separation between external circuits and earth		N
5.4.11.2	Requirements		N

Any report having not been signed by authorized approver, or having been altered without authorization, or having not been stamped by the “Dedicated Testing/Inspection Stamp” is deemed to be invalid. Copying or excerpting portion of, or altering the content of the report is not permitted without the written authorization of AGC. The test results presented in the report apply only to the tested sample. Any objections to report issued by AGC should be submitted to AGC within 15days after the issuance of the test report. Further enquiry of validity or verification of the test report should be addressed to AGC by agc01@agccert.com.

EN IEC 62368-1			
Clause	Requirement + Test	Result - Remark	Verdict
	SPDs bridge separation between external circuit and earth		N
	Rated operating voltage $U_{op}$ (V).....		—
	Nominal voltage $U_{peak}$ (V).....		—
	Max increase due to variation $\Delta U_{sp}$ .....		—
	Max increase due to ageing $\Delta U_{sa}$ .....		—
5.4.11.3	Test method and compliance.....		N
5.4.12	Insulating liquid		N
5.4.12.1	General requirements		N
5.4.12.2	Electric strength of an insulating liquid.....		N
5.4.12.3	Compatibility of an insulating liquid.....		N
5.4.12.4	Container for insulating liquid.....		N
<b>5.5</b>	<b>Components as safeguards</b>		N
5.5.1	General		N
5.5.2	Capacitors and RC units		N
5.5.2.1	General requirement		N
5.5.2.2	Safeguards against capacitor discharge after disconnection of a connector.....		N
5.5.3	Transformers		N
5.5.4	Optocouplers		N
5.5.5	Relays		N
5.5.6	Resistors		N
5.5.7	SPDs		N
5.5.8	Insulation between the mains and an external circuit consisting of a coaxial cable.....		N
5.5.9	Safeguards for socket-outlets in outdoor equipment		N
	RCD rated residual operating current (mA).....		—
<b>5.6</b>	<b>Protective conductor</b>		N
5.6.2	Requirement for protective conductors		N
5.6.2.1	General requirements		N
5.6.2.2	Colour of insulation		N
5.6.3	Requirement for protective earthing conductors		N
	Protective earthing conductor size (mm <sup>2</sup> ) .....		—

Any report having not been signed by authorized approver, or having been altered without authorization, or having not been stamped by the “Dedicated Testing/Inspection Stamp” is deemed to be invalid. Copying or excerpting portion of, or altering the content of the report is not permitted without the written authorization of AGC. The test results presented in the report apply only to the tested sample. Any objections to report issued by AGC should be submitted to AGC within 15days after the issuance of the test report. Further enquiry of validity or verification of the test report should be addressed to AGC by agc01@agccert.com.

EN IEC 62368-1			
Clause	Requirement + Test	Result - Remark	Verdict
	Protective earthing conductor serving as a reinforced safeguard		N
	Protective earthing conductor serving as a double safeguard		N
5.6.4	Requirements for protective bonding conductors		N
5.6.4.1	Protective bonding conductors		N
	Protective bonding conductor size (mm <sup>2</sup> )..... :		—
5.6.4.2	Protective current rating (A)..... :		N
5.6.5	Terminals for protective conductors		N
5.6.5.1	Terminal size for connecting protective earthing conductors (mm)..... :		N
	Terminal size for connecting protective bonding conductors (mm)..... :		N
5.6.5.2	Corrosion		N
5.6.6	Resistance of the protective bonding system		N
5.6.6.1	Requirements		N
5.6.6.2	Test Method..... :		N
5.6.6.3	Resistance ( $\Omega$ ) or voltage drop..... :		N
5.6.7	Reliable connection of a protective earthing conductor		N
5.6.8	Functional earthing		N
	Conductor size (mm <sup>2</sup> )..... :		N
	Class II with functional earthing marking .....		N
	Appliance inlet cl & cr (mm)..... :		N
<b>5.7</b>	<b>Prospective touch voltage, touch current and protective conductor current</b>		N
5.7.2	Measuring devices and networks		N
5.7.2.1	Measurement of touch current		N
5.7.2.2	Measurement of voltage		N
5.7.3	Equipment set-up, supply connections and earth connections		N
5.7.4	Unearthed accessible parts..... :		N
5.7.5	Earthed accessible conductive parts..... :		N
5.7.6	Requirements when touch current exceeds ES2 limits		N
	Protective conductor current (mA)..... :		N
	Instructional Safeguard..... :		N

Any report having not been signed by authorized approver, or having been altered without authorization, or having not been stamped by the “Dedicated Testing/Inspection Stamp” is deemed to be invalid. Copying or excerpting portion of, or altering the content of the report is not permitted without the written authorization of AGC. The test results presented in the report apply only to the tested sample. Any objections to report issued by AGC should be submitted to AGC within 15days after the issuance of the test report. Further enquiry of validity or verification of the test report should be addressed to AGC by agc01@agccert.com.

EN IEC 62368-1			
Clause	Requirement + Test	Result - Remark	Verdict
5.7.7	Prospective touch voltage and touch current associated with external circuits		N
5.7.7.1	Touch current from coaxial cables		N
5.7.7.2	Prospective touch voltage and touch current associated with paired conductor cables		N
5.7.8	Summation of touch currents from external circuits		N
	a) Equipment connected to earthed external circuits, current (mA).....:		N
	b) Equipment connected to unearthed external circuits, current (mA).....:		N
<b>5.8</b>	<b>Backfeed safeguard in battery backed up supplies</b>		N
	Mains terminal ES.....:		N
	Air gap (mm).....:		N
<b>6</b>	<b>ELECTRICALLY- CAUSED FIRE</b>		P
<b>6.2</b>	<b>Classification of PS and PIS</b>		P
6.2.2	Power source circuit classifications.....:	PS (power source) classification determined by measuring the maximum power in Figures 34 and 35 for load and power source circuits.	P
6.2.3	Classification of potential ignition sources		P
6.2.3.1	Arcing PIS .....		N
6.2.3.2	Resistive PIS .....		P
<b>6.3</b>	<b>Safeguards against fire under normal operating and abnormal operating conditions</b>		P
6.3.1	No ignition and attainable temperature value less than 90 % defined by ISO 871 or less than 300 °C for unknown materials.....:	(See appended table B.1.5 and B.3)	P
	Combustible materials outside fire enclosure.....:	No such materials used.	N
<b>6.4</b>	<b>Safeguards against fire under single fault conditions</b>		P
6.4.1	Safeguard method		P
6.4.2	Reduction of the likelihood of ignition under single fault conditions in PS1 circuits		N
6.4.3	Reduction of the likelihood of ignition under single fault conditions in PS2 and PS3 circuits	Method by control of fire spread.	N
6.4.3.1	Supplementary safeguards		N
6.4.3.2	Single Fault Conditions.....:		N

Any report having not been signed by authorized approver, or having been altered without authorization, or having not been stamped by the "Dedicated Testing/Inspection Stamp" is deemed to be invalid. Copying or excerpting portion of, or altering the content of the report is not permitted without the written authorization of AGC. The test results presented in the report apply only to the tested sample. Any objections to report issued by AGC should be submitted to AGC within 15days after the issuance of the test report. Further enquiry of validity or verification of the test report should be addressed to AGC by agc01@agccert.com.



EN IEC 62368-1			
Clause	Requirement + Test	Result - Remark	Verdict
	Special conditions for temperature limited by fuse		N
6.4.4	Control of fire spread in PS1 circuits		P
6.4.5	Control of fire spread in PS2 circuits		P
6.4.5.2	Supplementary safeguards	Refer to appended table 4.1.2 for detail. PCB rated V-0, Plastic enclosure V-0 used.	P
6.4.6	Control of fire spread in PS3 circuits		N
6.4.7	Separation of combustible materials from a PIS		N
6.4.7.2	Separation by distance		N
6.4.7.3	Separation by a fire barrier		N
6.4.8	Fire enclosures and fire barriers	Equipment enclosure was evaluated as a fire enclosure.	P
6.4.8.2	Fire enclosure and fire barrier material properties	See the following details.	P
6.4.8.2.1	Requirements for a fire barrier	No such construction.	N
6.4.8.2.2	Requirements for a fire enclosure	Equipment fire enclosure was made of min. V-0 material.	P
6.4.8.3	Constructional requirements for a fire enclosure and a fire barrier	See the following details.	P
6.4.8.3.1	Fire enclosure and fire barrier openings	No opening	N
6.4.8.3.2	Fire barrier dimensions	No barrier used.	N
6.4.8.3.3	Top openings and properties		N
	Openings dimensions (mm)..... :		N
6.4.8.3.4	Bottom openings and properties		N
	Openings dimensions (mm)..... :		N
	Flammability tests for the bottom of a fire enclosure		N
	Instructional Safeguard..... :		N
6.4.8.3.5	Side openings and properties		N
	Openings dimensions (mm)..... :		N
6.4.8.3.6	Integrity of a fire enclosure, condition met: a), b) or c)..... :		N
6.4.8.4	Separation of a PIS from a fire enclosure and a fire barrier distance (mm) or flammability rating... :	Equipment fire enclosure was made of min. V-0 material.	P
6.4.9	Flammability of insulating liquid..... :		N
<b>6.5</b>	<b>Internal and external wiring</b>		P
6.5.1	General requirements		P

Any report having not been signed by authorized approver, or having been altered without authorization, or having not been stamped by the "Dedicated Testing/Inspection Stamp" is deemed to be invalid. Copying or excerpting portion of, or altering the content of the report is not permitted without the written authorization of AGC. The test results presented in the report apply only to the tested sample. Any objections to report issued by AGC should be submitted to AGC within 15days after the issuance of the test report. Further enquiry of validity or verification of the test report should be addressed to AGC by agc01@agccert.com.

EN IEC 62368-1			
Clause	Requirement + Test	Result - Remark	Verdict
6.5.2	Requirements for interconnection to building wiring.....:	(See appended table 4.1.2)	—
6.5.3	Internal wiring size (mm <sup>2</sup> ) for socket-outlets.....:	No such wiring, outlet and inlet.	N
<b>6.6</b>	<b>Safeguards against fire due to the connection to additional equipment</b>		N
<b>7</b>	<b>INJURY CAUSED BY HAZARDOUS SUBSTANCES</b>		P
<b>7.2</b>	<b>Reduction of exposure to hazardous substances</b>		N
<b>7.3</b>	<b>Ozone exposure</b>		N
<b>7.4</b>	<b>Use of personal safeguards or personal protective equipment (PPE)</b>		N
	Personal safeguards and instructions.....:	No PPE used.	—
<b>7.5</b>	<b>Use of instructional safeguards and instructions</b>		N
	Instructional safeguard (ISO 7010).....:		—
<b>7.6</b>	<b>Batteries and their protection circuits</b>		P
<b>8</b>	<b>MECHANICALLY-CAUSED INJURY</b>		P
<b>8.2</b>	<b>Mechanical energy source classifications</b>		P
<b>8.3</b>	<b>Safeguards against mechanical energy sources</b>		N
<b>8.4</b>	<b>Safeguards against parts with sharp edges and corners</b>		N
8.4.1	Safeguards	MS1 only	N
	Instructional Safeguard.....:		N
8.4.2	Sharp edges or corners	No sharp edges and corners	N
<b>8.5</b>	<b>Safeguards against moving parts</b>		N
8.5.1	Fingers, jewellery, clothing, hair, etc., contact with MS2 or MS3 parts		N
	MS2 or MS3 part required to be accessible for the function of the equipment		N
	Moving MS3 parts only accessible to skilled person		N
8.5.2	Instructional safeguard.....:		N
8.5.4	Special categories of equipment containing moving parts		N
8.5.4.1	General		N
8.5.4.2	Equipment containing work cells with MS3 parts		N
8.5.4.2.1	Protection of persons in the work cell		N
8.5.4.2.2	Access protection override		N
8.5.4.2.2.1	Override system		N
8.5.4.2.2.2	Visual indicator		N

Any report having not been signed by authorized approver, or having been altered without authorization, or having not been stamped by the “Dedicated Testing/Inspection Stamp” is deemed to be invalid. Copying or excerpting portion of, or altering the content of the report is not permitted without the written authorization of AGC. The test results presented in the report apply only to the tested sample. Any objections to report issued by AGC should be submitted to AGC within 15days after the issuance of the test report. Further enquiry of validity or verification of the test report should be addressed to AGC by agc01@agccert.com.

EN IEC 62368-1			
Clause	Requirement + Test	Result - Remark	Verdict
8.5.4.2.3	Emergency stop system		N
	Maximum stopping distance from the point of activation (m)..... :		N
	Space between end point and nearest fixed mechanical part (mm)..... :		N
8.5.4.2.4	Endurance requirements		N
	Mechanical system subjected to 100 000 cycles of operation		N
	- Mechanical function check and visual inspection		N
	- Cable assembly..... :		N
8.5.4.3	Equipment having electromechanical device for destruction of media		N
8.5.4.3.1	Equipment safeguards		N
8.5.4.3.2	Instructional safeguards against moving parts..... :		N
8.5.4.3.3	Disconnection from the supply		N
8.5.4.3.4	Cut type and test force (N)..... :		N
8.5.4.3.5	Compliance		N
8.5.5	High pressure lamps		N
	Explosion test..... :		N
8.5.5.3	Glass particles dimensions (mm)..... :		N
<b>8.6</b>	<b>Stability of equipment</b>		N
8.6.1	General		N
	Instructional safeguard..... :		N
8.6.2	Static stability		N
8.6.2.2	Static stability test..... :		N
8.6.2.3	Downward force test		N
8.6.3	Relocation stability		N
	Wheels diameter (mm)..... :		—
	Tilt test		N
8.6.4	Glass slide test		N
8.6.5	Horizontal force test..... :		N
<b>8.7</b>	<b>Equipment mounted to wall, ceiling or other structure</b>		N
8.7.1	Mount means type..... :		N
8.7.2	Test methods		N

Any report having not been signed by authorized approver, or having been altered without authorization, or having not been stamped by the “Dedicated Testing/Inspection Stamp” is deemed to be invalid. Copying or excerpting portion of, or altering the content of the report is not permitted without the written authorization of AGC. The test results presented in the report apply only to the tested sample. Any objections to report issued by AGC should be submitted to AGC within 15days after the issuance of the test report. Further enquiry of validity or verification of the test report should be addressed to AGC by agc01@agccert.com.

EN IEC 62368-1			
Clause	Requirement + Test	Result - Remark	Verdict
	Test 1, additional downwards force (N)..... :		N
	Test 2, number of attachment points and test force (N)..... :		N
	Test 3 Nominal diameter (mm) and applied torque (Nm)..... :		N
<b>8.8</b>	<b>Handles strength</b>		N
8.8.1	General	No handles.	N
8.8.2	Handle strength test		N
	Number of handles..... :		—
	Force applied (N)..... :		—
<b>8.9</b>	<b>Wheels or casters attachment requirements</b>		N
8.9.2	Pull test	No wheels or casters	N
<b>8.10</b>	<b>Carts, stands and similar carriers</b>		N
8.10.1	General	No such part	N
8.10.2	Marking and instructions..... :		N
8.10.3	Cart, stand or carrier loading test		N
	Loading force applied (N)..... :		N
8.10.4	Cart, stand or carrier impact test		N
8.10.5	Mechanical stability		N
	Force applied (N)..... :		—
8.10.6	Thermoplastic temperature stability		N
<b>8.11</b>	<b>Mounting means for slide-rail mounted equipment (SRME)</b>		N
8.11.1	General	No slide-rail mounted.	N
8.11.2	Requirements for slide rails		N
	Instructional Safeguard..... :		N
8.11.3	Mechanical strength test		N
8.11.3.1	Downward force test, force (N) applied..... :		N
8.11.3.2	Lateral push force test		N
8.11.3.3	Integrity of slide rail end stops		N
8.11.4	Compliance		N
<b>8.12</b>	<b>Telescoping or rod antennas</b>		N
	Button/ball diameter (mm)..... :	No antenna	—
<b>9</b>	<b>THERMAL BURN INJURY</b>		P
<b>9.2</b>	<b>Thermal energy source classifications</b>		P

Any report having not been signed by authorized approver, or having been altered without authorization, or having not been stamped by the “Dedicated Testing/Inspection Stamp” is deemed to be invalid. Copying or excerpting portion of, or altering the content of the report is not permitted without the written authorization of AGC. The test results presented in the report apply only to the tested sample. Any objections to report issued by AGC should be submitted to AGC within 15days after the issuance of the test report. Further enquiry of validity or verification of the test report should be addressed to AGC by agc01@agccert.com.

EN IEC 62368-1			
Clause	Requirement + Test	Result - Remark	Verdict
<b>9.3</b>	<b>Touch temperature limits</b>		P
9.3.1	Touch temperatures of accessible parts.....:	(See appended table 9.3)	P
9.3.2	Test method and compliance	Checked by test.	P
<b>9.4</b>	<b>Safeguards against thermal energy sources</b>		P
<b>9.5</b>	<b>Requirements for safeguards</b>		P
9.5.1	Equipment safeguard	Enclosure as a safe guard.	P
9.5.2	Instructional safeguard.....:		N
<b>9.6</b>	<b>Requirements for wireless power transmitters</b>		N
9.6.1	General	No wireless power transmitters	N
9.6.2	Specification of the foreign objects		N
9.6.3	Test method and compliance.....:		N
<b>10</b>	<b>RADIATION</b>		P
<b>10.2</b>	<b>Radiation energy source classification</b>		P
10.2.1	General classification		P
	Lasers.....:		—
	Lamps and lamp systems.....:	RS1: Indicator LED	—
	Image projectors.....:		—
	X-Ray.....:		—
	Personal music player.....:		—
<b>10.3</b>	<b>Safeguards against laser radiation</b>		N
	The standard(s) equipment containing laser(s) comply.....:	No laser	N
<b>10.4</b>	<b>Safeguards against optical radiation from lamps and lamp systems (including LED types)</b>		N
10.4.1	General requirements		N
	Instructional safeguard provided for accessible radiation level needs to exceed		N
	Risk group marking and location.....:		N
	Information for safe operation and installation		N
10.4.2	Requirements for enclosures		N
	UV radiation exposure.....:		N
10.4.3	Instructional safeguard.....:		N
<b>10.5</b>	<b>Safeguards against X-radiation</b>		N
10.5.1	Requirements	No X-radiation	N

Any report having not been signed by authorized approver, or having been altered without authorization, or having not been stamped by the “Dedicated Testing/Inspection Stamp” is deemed to be invalid. Copying or excerpting portion of, or altering the content of the report is not permitted without the written authorization of AGC. The test results presented in the report apply only to the tested sample. Any objections to report issued by AGC should be submitted to AGC within 15days after the issuance of the test report. Further enquiry of validity or verification of the test report should be addressed to AGC by agc01@agccert.com.

EN IEC 62368-1			
Clause	Requirement + Test	Result - Remark	Verdict
	Instructional safeguard for skilled persons..... :		—
10.5.3	Maximum radiation (pA/kg)..... :		—
<b>10.6</b>	<b>Safeguards against acoustic energy sources</b>		P
10.6.1	General		P
10.6.2	Classification		N
	Acoustic output $L_{Aeq,T}$ , dB(A)..... :		N
	Unweighted RMS output voltage (mV)..... :		N
	Digital output signal (dBFS)..... :		N
10.6.3	Requirements for dose-based systems		N
10.6.3.1	General requirements		N
10.6.3.2	Dose-based warning and automatic decrease		N
10.6.3.3	Exposure-based warning and requirements		N
	30 s integrated exposure level (MEL30)..... :		N
	Warning for MEL $\geq 100$ dB(A)..... :		N
10.6.4	Measurement methods		N
10.6.5	Protection of persons		N
	Instructional safeguards..... :		N
10.6.6	Requirements for listening devices (headphones, earphones, etc.)		P
10.6.6.1	Corded listening devices with analogue input		N
	Listening device input voltage (mV)..... :		N
10.6.6.2	Corded listening devices with digital input		N
	Max. acoustic output $L_{Aeq,T}$ , dB(A)..... :		N
10.6.6.3	Cordless listening devices		P
	Max. acoustic output $L_{Aeq,T}$ , dB(A)..... :	Left: 83.33dB Right: 89.02dB Limit: $\leq 100$ dB	P
<b>B</b>	<b>NORMAL OPERATING CONDITION TESTS, ABNORMAL OPERATING CONDITION TESTS AND SINGLE FAULT CONDITION TESTS</b>		P
<b>B.1</b>	<b>General</b>		P
B.1.5	Temperature measurement conditions	(See appended table B.1.5)	P
<b>B.2</b>	<b>Normal operating conditions</b>		P
B.2.1	General requirements..... :	(See Test Item Particulars and appended test tables)	P

Any report having not been signed by authorized approver, or having been altered without authorization, or having not been stamped by the "Dedicated Testing/Inspection Stamp" is deemed to be invalid. Copying or excerpting portion of, or altering the content of the report is not permitted without the written authorization of AGC. The test results presented in the report apply only to the tested sample. Any objections to report issued by AGC should be submitted to AGC within 15days after the issuance of the test report. Further enquiry of validity or verification of the test report should be addressed to AGC by agc01@agccert.com.



EN IEC 62368-1			
Clause	Requirement + Test	Result - Remark	Verdict
	Audio Amplifiers and equipment with audio amplifiers..... :		N
B.2.3	Supply voltage and tolerances	(See appended table B.2.5)	P
B.2.5	Input test..... :	(See appended table B.2.5)	P
<b>B.3</b>	<b>Simulated abnormal operating conditions</b>		P
B.3.1	General		P
B.3.2	Covering of ventilation openings	No ventilation openings	N
	Instructional safeguard..... :		N
B.3.3	DC mains polarity test	No DC mains	N
B.3.4	Setting of voltage selector	No such device.	N
B.3.5	Maximum load at output terminals		N
B.3.6	Reverse battery polarity		N
B.3.7	Audio amplifier abnormal operating conditions		P
B.3.8	Safeguards functional during and after abnormal operating conditions..... :		P
<b>B.4</b>	<b>Simulated single fault conditions</b>		P
B.4.1	General		P
B.4.2	Temperature controlling device		N
B.4.3	Blocked motor test		N
B.4.4	Functional insulation	See the following details.	P
B.4.4.1	Short circuit of clearances for functional insulation	(See appended table B.3 &B.4)	P
B.4.4.2	Short circuit of creepage distances for functional insulation	(See appended table B.3 &B.4)	P
B.4.4.3	Short circuit of functional insulation on coated printed boards	No coated printed boards within the EUT	N
B.4.5	Short-circuit and interruption of electrodes in tubes and semiconductors		P
B.4.6	Short circuit or disconnection of passive components	(See appended table B.3 &B.4)	P
B.4.7	Continuous operation of components	The EUT is continuous operating type and no such components intended for short time operation or intermittent operation	N
B.4.8	Compliance during and after single fault conditions..... :	(See appended table B.3&B.4)	P
B.4.9	Battery charging and discharging under single fault conditions	Complied with the annex M	P

Any report having not been signed by authorized approver, or having been altered without authorization, or having not been stamped by the “Dedicated Testing/Inspection Stamp” is deemed to be invalid. Copying or excerpting portion of, or altering the content of the report is not permitted without the written authorization of AGC. The test results presented in the report apply only to the tested sample. Any objections to report issued by AGC should be submitted to AGC within 15days after the issuance of the test report. Further enquiry of validity or verification of the test report should be addressed to AGC by agc01@agccert.com.



EN IEC 62368-1			
Clause	Requirement + Test	Result - Remark	Verdict
<b>C</b>	<b>UV RADIATION</b>		N
<b>C.1</b>	<b>Protection of materials in equipment from UV radiation</b>		N
C.1.2	Requirements	No UV radiation	N
C.1.3	Test method		N
<b>C.2</b>	<b>UV light conditioning test</b>		N
C.2.1	Test apparatus..... :		N
C.2.2	Mounting of test samples		N
C.2.3	Carbon-arc light-exposure test		N
C.2.4	Xenon-arc light-exposure test		N
<b>D</b>	<b>TEST GENERATORS</b>		N
<b>D.1</b>	<b>Impulse test generators</b>		N
<b>D.2</b>	<b>Antenna interface test generator</b>		N
<b>D.3</b>	<b>Electronic pulse generator</b>		N
<b>E</b>	<b>TEST CONDITIONS FOR EQUIPMENT CONTAINING AUDIO AMPLIFIERS</b>		P
<b>E.1</b>	<b>Electrical energy source classification for audio signals</b>		N
	Maximum non-clipped output power (W)..... :		—
	Rated load impedance ( $\Omega$ ) ..... :		—
	Open-circuit output voltage (V)..... :		—
	Instructional safeguard..... :		—
<b>E.2</b>	<b>Audio amplifier normal operating conditions</b>		N
	Audio signal source type..... :		—
	Audio output power (W)..... :		—
	Audio output voltage (V)..... :		—
	Rated load impedance ( $\Omega$ ) ..... :		—
	Requirements for temperature measurement		N
E.3	Audio amplifier abnormal operating conditions		P
<b>F</b>	<b>EQUIPMENT MARKINGS, INSTRUCTIONS, AND INSTRUCTIONAL SAFEGUARDS</b>		P
<b>F.1</b>	<b>General</b>		P
	Language ..... :	Only english version review. Versions in other language will be provided when submitted for national approval.	—
<b>F.2</b>	<b>Letter symbols and graphical symbols</b>		P

Any report having not been signed by authorized approver, or having been altered without authorization, or having not been stamped by the “Dedicated Testing/Inspection Stamp” is deemed to be invalid. Copying or excerpting portion of, or altering the content of the report is not permitted without the written authorization of AGC. The test results presented in the report apply only to the tested sample. Any objections to report issued by AGC should be submitted to AGC within 15days after the issuance of the test report. Further enquiry of validity or verification of the test report should be addressed to AGC by agc01@agccert.com.

EN IEC 62368-1			
Clause	Requirement + Test	Result - Remark	Verdict
F.2.1	Letter symbols according to IEC60027-1	Letter symbols for quantities and units are complied with IEC 60027-1.	P
F.2.2	Graphic symbols according to IEC, ISO or manufacturer specific	Graphical symbols are complied with IEC 60417, ISO 3864-2, ISO 7000 or ISO 7010.	P
<b>F.3</b>	<b>Equipment markings</b>		P
F.3.1	Equipment marking locations	Equipment marking is located on the exterior surface and is easily visible.	P
F.3.2	Equipment identification markings	See the following details.	P
F.3.2.1	Manufacturer identification .....	See copy of marking plate.	—
F.3.2.2	Model identification .....	See copy of marking plate.	—
F.3.3	Equipment rating markings	See the following details.	P
F.3.3.1	Equipment with direct connection to mains		N
F.3.3.2	Equipment without direct connection to mains	See above.	P
F.3.3.3	Nature of the supply voltage.....	--- (no show)	P
F.3.3.4	Rated voltage.....	5V(no show)	P
F.3.3.5	Rated frequency.....		N
F.3.3.6	Rated current or rated power.....	185mA (no show)	P
F.3.3.7	Equipment with multiple supply connections		N
F.3.4	Voltage setting device		N
F.3.5	Terminals and operating devices		N
F.3.5.1	Mains appliance outlet and socket-outlet markings.....	No such devices on the equipment.	N
F.3.5.2	Switch position identification marking.....	No such switch on the equipment.	N
F.3.5.3	Replacement fuse identification and rating markings.....		N
	Instructional safeguards for neutral fuse.....		N
F.3.5.4	Replacement battery identification marking.....		N
F.3.5.5	Neutral conductor terminal		N
F.3.5.6	Terminal marking location		N
F.3.6	Equipment markings related to equipment classification	Class III	N
F.3.6.1	Class I equipment		N
F.3.6.1.1	Protective earthing conductor terminal.....		N
F.3.6.1.2	Protective bonding conductor terminals .....		N

Any report having not been signed by authorized approver, or having been altered without authorization, or having not been stamped by the "Dedicated Testing/Inspection Stamp" is deemed to be invalid. Copying or excerpting portion of, or altering the content of the report is not permitted without the written authorization of AGC. The test results presented in the report apply only to the tested sample. Any objections to report issued by AGC should be submitted to AGC within 15days after the issuance of the test report. Further enquiry of validity or verification of the test report should be addressed to AGC by agc01@agccert.com.

EN IEC 62368-1			
Clause	Requirement + Test	Result - Remark	Verdict
F.3.6.2	Equipment class marking..... :		N
F.3.6.3	Functional earthing terminal marking..... :		N
F.3.7	Equipment IP rating marking.....:	This equipment is classified as IPX0.	—
F.3.8	External power supply output marking..... :		N
F.3.9	Durability, legibility and permanence of marking	See the following details.	P
F.3.10	Test for permanence of markings	The label was subjected to the permanence of marking test, 15 sec. for water and 15 sec. for petroleum spirit. After each test, the marking remained legible.	P
<b>F.4</b>	<b>Instructions</b>		P
	a)... Information prior to installation and initial use		N
	b)... Equipment for use in locations where children not likely to be present	Relevant safety caution texts and installation instruction are available.	P
	c)... Instructions for installation and interconnection		P
	d)... Equipment intended for use only in restricted access area		N
	e)... Equipment intended to be fastened in place	No such terminal	N
	f)... Instructions for audio equipment terminals		N
	g)... Protective earthing used as a safeguard		N
	h)... Protective conductor current exceeding ES2 limits		N
	i).... Graphic symbols used on equipment	The EUT is not a permanently connected equipment	N
	j).... Permanently connected equipment not provided with all-pole mains switch		N
	k)... Replaceable components or modules providing safeguard function		N
	l).... Equipment containing insulating liquid		N
	m).. Installation instructions for outdoor equipment		N
<b>F.5</b>	<b>Instructional safeguards</b>		P
<b>G</b>	<b>COMPONENTS</b>		P
<b>G.1</b>	<b>Switches</b>		N
G.1.1	General		N

Any report having not been signed by authorized approver, or having been altered without authorization, or having not been stamped by the “Dedicated Testing/Inspection Stamp” is deemed to be invalid. Copying or excerpting portion of, or altering the content of the report is not permitted without the written authorization of AGC. The test results presented in the report apply only to the tested sample. Any objections to report issued by AGC should be submitted to AGC within 15days after the issuance of the test report. Further enquiry of validity or verification of the test report should be addressed to AGC by agc01@agccert.com.

EN IEC 62368-1			
Clause	Requirement + Test	Result - Remark	Verdict
G.1.2	Ratings, endurance, spacing, maximum load		N
G.1.3	Test method and compliance		N
<b>G.2</b>	<b>Relays</b>		N
G.2.1	Requirements	No relays	N
G.2.2	Overload test		N
G.2.3	Relay controlling connectors supplying power to other equipment		N
G.2.4	Test method and compliance		N
<b>G.3</b>	<b>Protective devices</b>		N
G.3.1	Thermal cut-offs	No such device	N
	Thermal cut-outs separately approved according to IEC 60730 with conditions indicated in a) & b)	No thermal cut-off provided within the equipment.	N
	Thermal cut-outs tested as part of the equipment as indicated in c)		N
G.3.1.2	Test method and compliance		N
G.3.2	Thermal links		N
G.3.2.1	a) Thermal links tested separately according to IEC 60691 with specifics		N
	b) Thermal links tested as part of the equipment		N
G.3.2.2	Test method and compliance		N
G.3.3	PTC thermistors	No such device	N
G.3.4	Overcurrent protection devices		N
G.3.5	Safeguards components not mentioned in G.3.1 to G.3.4		N
G.3.5.1	Non-resettable devices suitably rated and marking provided		N
G.3.5.2	Single faults conditions..... :		N
<b>G.4</b>	<b>Connectors</b>		N
G.4.1	Spacings	No such connector within the EUT	N
G.4.2	Mains connector configuration..... :		N
G.4.3	Plug is shaped that insertion into mains socket-outlets or appliance coupler is unlikely		N
<b>G.5</b>	<b>Wound components</b>		N
G.5.1	Wire insulation in wound components	No such component.	N
G.5.1.2	Protection against mechanical stress		N
G.5.2	Endurance test		N

Any report having not been signed by authorized approver, or having been altered without authorization, or having not been stamped by the "Dedicated Testing/Inspection Stamp" is deemed to be invalid. Copying or excerpting portion of, or altering the content of the report is not permitted without the written authorization of AGC. The test results presented in the report apply only to the tested sample. Any objections to report issued by AGC should be submitted to AGC within 15days after the issuance of the test report. Further enquiry of validity or verification of the test report should be addressed to AGC by agc01@agccert.com.

EN IEC 62368-1			
Clause	Requirement + Test	Result - Remark	Verdict
G.5.2.1	General test requirements		N
G.5.2.2	Heat run test		N
	Test time (days per cycle)..... :		—
	Test temperature (°C)..... :		—
G.5.2.3	Wound components supplied from the mains		N
G.5.2.4	No insulation breakdown		N
G.5.3	Transformers		N
G.5.3.1	Compliance method.....:		N
	Position.....:		N
	Method of protection.....:		N
G.5.3.2	Insulation		N
	Protection from displacement of windings..... :		—
G.5.3.3	Transformer overload tests		N
G.5.3.3.1	Test conditions		N
G.5.3.3.2	Winding temperatures		N
G.5.3.3.3	Winding temperatures - alternative test method		N
G.5.3.4	Transformers using FIW		N
G.5.3.4.1	General		N
	FIW wire nominal diameter.....:		—
G.5.3.4.2	Transformers with basic insulation only		N
G.5.3.4.3	Transformers with double insulation or reinforced insulation..... :		N
G.5.3.4.4	Transformers with FIW wound on metal or ferrite core		N
G.5.3.4.5	Thermal cycling test and compliance		N
G.5.3.4.6	Partial discharge test		N
G.5.3.4.7	Routine test		N
G.5.4	Motors		N
G.5.4.1	General requirements		N
G.5.4.2	Motor overload test conditions		N
G.5.4.3	Running overload test		N
G.5.4.4.2	Locked-rotor overload test		N
	Test duration (days) ..... :		—
G.5.4.5	Running overload test for DC motors		N

Any report having not been signed by authorized approver, or having been altered without authorization, or having not been stamped by the “Dedicated Testing/Inspection Stamp” is deemed to be invalid. Copying or excerpting portion of, or altering the content of the report is not permitted without the written authorization of AGC. The test results presented in the report apply only to the tested sample. Any objections to report issued by AGC should be submitted to AGC within 15days after the issuance of the test report. Further enquiry of validity or verification of the test report should be addressed to AGC by agc01@agccert.com.

EN IEC 62368-1			
Clause	Requirement + Test	Result - Remark	Verdict
G.5.4.5.2	Tested in the unit		N
G.5.4.5.3	Alternative method		N
G.5.4.6	Locked-rotor overload test for DC motors		N
G.5.4.6.2	Tested in the unit		N
	Maximum Temperature .....		N
G.5.4.6.3	Alternative method		N
G.5.4.7	Motors with capacitors		N
G.5.4.8	Three-phase motors		N
G.5.4.9	Series motors		N
	Operating voltage .....		—
<b>G.6</b>	<b>Wire Insulation</b>		N
G.6.1	General		N
G.6.2	Enamelled winding wire insulation		N
<b>G.7</b>	<b>Mains supply cords</b>		N
G.7.1	General requirements		N
	Type.....		—
G.7.2	Cross sectional area (mm <sup>2</sup> or AWG).....		N
G.7.3	Cord anchorages and strain relief for non-detachable power supply cords		N
G.7.3.2	Cord strain relief		N
G.7.3.2.1	Requirements		N
	Strain relief test force (N).....		N
G.7.3.2.2	Strain relief mechanism failure		N
G.7.3.2.3	Cord sheath or jacket position, distance (mm).....		N
G.7.3.2.4	Strain relief and cord anchorage material		N
G.7.4	Cord Entry		N
G.7.5	Non-detachable cord bend protection		N
G.7.5.1	Requirements		N
G.7.5.2	Test method and compliance		N
	Overall diameter or minor overall dimension, <i>D</i> (mm).....		—
	Radius of curvature after test (mm).....		—
G.7.6	Supply wiring space		N
G.7.6.1	General requirements		N

Any report having not been signed by authorized approver, or having been altered without authorization, or having not been stamped by the “Dedicated Testing/Inspection Stamp” is deemed to be invalid. Copying or excerpting portion of, or altering the content of the report is not permitted without the written authorization of AGC. The test results presented in the report apply only to the tested sample. Any objections to report issued by AGC should be submitted to AGC within 15days after the issuance of the test report. Further enquiry of validity or verification of the test report should be addressed to AGC by agc01@agccert.com.

EN IEC 62368-1			
Clause	Requirement + Test	Result - Remark	Verdict
G.7.6.2	Stranded wire		N
G.7.6.2.1	Requirements		N
G.7.6.2.2	Test with 8 mm strand		N
<b>G.8</b>	<b>Varistors</b>		N
G.8.1	General requirements	No such device.	N
G.8.2	Safeguards against fire		N
G.8.2.1	General		N
G.8.2.2	Varistor overload test		N
G.8.2.3	Temporary overvoltage test		N
<b>G.9</b>	<b>Integrated circuit (IC) current limiters</b>		N
G.9.1	Requirements		N
	IC limiter output current (max. 5A)..... :		—
	Manufacturers' defined drift .....:		—
G.9.2	Test Program		N
G.9.3	Compliance		N
<b>G.10</b>	<b>Resistors</b>		N
G.10.1	General	No such device.	N
G.10.2	Conditioning		N
G.10.3	Resistor test		N
G.10.4	Voltage surge test		N
G.10.5	Impulse test		N
G.10.6	Overload test		N
<b>G.11</b>	<b>Capacitors and RC units</b>		N
G.11.1	General requirements		N
G.11.2	Conditioning of capacitors and RC units		N
G.11.3	Rules for selecting capacitors		N
<b>G.12</b>	<b>Optocouplers</b>		N
	Optocouplers comply with IEC 60747-5-5 with specifics	No such device.	N
	Type test voltage $V_{ini,a}$ ..... :		—
	Routine test voltage, $V_{ini,b}$ ..... :		—
<b>G.13</b>	<b>Printed boards</b>		P
G.13.1	General requirements		P
G.13.2	Uncoated printed boards		P

Any report having not been signed by authorized approver, or having been altered without authorization, or having not been stamped by the "Dedicated Testing/Inspection Stamp" is deemed to be invalid. Copying or excerpting portion of, or altering the content of the report is not permitted without the written authorization of AGC. The test results presented in the report apply only to the tested sample. Any objections to report issued by AGC should be submitted to AGC within 15days after the issuance of the test report. Further enquiry of validity or verification of the test report should be addressed to AGC by agc01@agccert.com.



EN IEC 62368-1			
Clause	Requirement + Test	Result - Remark	Verdict
G.13.3	Coated printed boards	No coated printed board provided within the equipment.	N
G.13.4	Insulation between conductors on the same inner surface		N
G.13.5	Insulation between conductors on different surfaces		N
	Distance through insulation..... :		N
	Number of insulation layers (pcs) ..... :		—
G.13.6	Tests on coated printed boards		N
G.13.6.1	Sample preparation and preliminary inspection		N
G.13.6.2	Test method and compliance		N
<b>G.14</b>	<b>Coating on components terminals</b>		N
G.14.1	Requirements ..... :		N
<b>G.15</b>	<b>Pressurized liquid filled components</b>		N
G.15.1	Requirements	No such components used	N
G.15.2	Test methods and compliance		N
G.15.2.1	Hydrostatic pressure test		N
G.15.2.2	Creep resistance test		N
G.15.2.3	Tubing and fittings compatibility test		N
G.15.2.4	Vibration test		N
G.15.2.5	Thermal cycling test		N
G.15.2.6	Force test		N
G.15.3	Compliance		N
<b>G.16</b>	<b>IC including capacitor discharge function (ICX)</b>		N
G.16.1	Condition for fault tested is not required	No such device	N
	ICX with associated circuitry tested in equipment		N
	ICX tested separately		N
G.16.2	Tests		N
	Smallest capacitance and smallest resistance specified by ICX manufacturer for impulse test.... :		—
	Mains voltage that impulses to be superimposed on..... :		—
	Largest capacitance and smallest resistance for ICX tested by itself for 10000 cycles test..... :		—
G.16.3	Capacitor discharge test..... :		N

Any report having not been signed by authorized approver, or having been altered without authorization, or having not been stamped by the “Dedicated Testing/Inspection Stamp” is deemed to be invalid. Copying or excerpting portion of, or altering the content of the report is not permitted without the written authorization of AGC. The test results presented in the report apply only to the tested sample. Any objections to report issued by AGC should be submitted to AGC within 15days after the issuance of the test report. Further enquiry of validity or verification of the test report should be addressed to AGC by agc01@agccert.com.

EN IEC 62368-1			
Clause	Requirement + Test	Result - Remark	Verdict
<b>H</b>	<b>CRITERIA FOR TELEPHONE RINGING SIGNALS</b>		N
<b>H.1</b>	<b>General</b>		N
<b>H.2</b>	<b>Method A</b>		N
<b>H.3</b>	<b>Method B</b>		N
H.3.1	Ringling signal	No such telephone ringing signal	N
H.3.1.1	Frequency (Hz) .....		—
H.3.1.2	Voltage (V) .....		—
H.3.1.3	Cadence; time (s) and voltage (V) .....		—
H.3.1.4	Single fault current (mA):.....		—
H.3.2	Tripping device and monitoring voltage		N
H.3.2.1	Conditions for use of a tripping device or a monitoring voltage		N
H.3.2.2	Tripping device		N
H.3.2.3	Monitoring voltage (V).....		N
<b>J</b>	<b>INSULATED WINDING WIRES FOR USE WITHOUT INTERLEAVED INSULATION</b>		N
<b>J.1</b>	<b>General</b>		N
	Winding wire insulation.....		—
	Solid round winding wire, diameter (mm).....		N
	Solid square and rectangular (flatwise bending) winding wire, cross-sectional area (mm <sup>2</sup> ).....		N
<b>J.2/J.3</b>	Tests and Manufacturing		—
<b>K</b>	<b>SAFETY INTERLOCKS</b>		N
<b>K.1</b>	<b>General requirements</b>		N
	Instructional safeguard.....	No such device.	N
<b>K.2</b>	<b>Components of safety interlock safeguard mechanism</b>		N
<b>K.3</b>	<b>Inadvertent change of operating mode</b>		N
<b>K.4</b>	<b>Interlock safeguard override</b>		N
<b>K.5</b>	<b>Fail-safe</b>		N
K.5.1	Under single fault condition		N
<b>K.6</b>	<b>Mechanically operated safety interlocks</b>		N
K.6.1	Endurance requirement		N
K.6.2	Test method and compliance.....		N
<b>K.7</b>	<b>Interlock circuit isolation</b>		N

Any report having not been signed by authorized approver, or having been altered without authorization, or having not been stamped by the “Dedicated Testing/Inspection Stamp” is deemed to be invalid. Copying or excerpting portion of, or altering the content of the report is not permitted without the written authorization of AGC. The test results presented in the report apply only to the tested sample. Any objections to report issued by AGC should be submitted to AGC within 15days after the issuance of the test report. Further enquiry of validity or verification of the test report should be addressed to AGC by agc01@agccert.com.

EN IEC 62368-1			
Clause	Requirement + Test	Result - Remark	Verdict
K.7.1	Separation distance for contact gaps & interlock circuit elements		N
	In circuit connected to mains, separation distance for contact gaps (mm)..... :		N
	In circuit isolated from mains, separation distance for contact gaps (mm)..... :		N
	Electric strength test before and after the test of K.7.2..... :		N
K.7.2	Overload test, Current (A)..... :		N
K.7.3	Endurance test		N
K.7.4	Electric strength test		N
<b>L</b>	<b>DISCONNECT DEVICES</b>		N
L.1	General requirements		N
L.2	Permanently connected equipment		N
L.3	Parts that remain energized		N
L.4	Single-phase equipment		N
L.5	Three-phase equipment		N
L.6	Switches as disconnect devices		N
L.7	Plugs as disconnect devices		N
L.8	Multiple power sources		N
	Instructional safeguard..... :		N
<b>M</b>	<b>EQUIPMENT CONTAINING BATTERIES AND THEIR PROTECTION CIRCUITS</b>		P
<b>M.1</b>	<b>General requirements</b>		P
<b>M.2</b>	<b>Safety of batteries and their cells</b>		P
M.2.1	Batteries and their cells comply with relevant IEC standards..... :		P
<b>M.3</b>	<b>Protection circuits for batteries provided within the equipment</b>		P
M.3.1	Requirements		P
M.3.2	Test method		P
	Overcharging of a rechargeable battery		P
	Excessive discharging		P
	Unintentional charging of a non-rechargeable battery		N
	Reverse charging of a rechargeable battery		N

Any report having not been signed by authorized approver, or having been altered without authorization, or having not been stamped by the "Dedicated Testing/Inspection Stamp" is deemed to be invalid. Copying or excerpting portion of, or altering the content of the report is not permitted without the written authorization of AGC. The test results presented in the report apply only to the tested sample. Any objections to report issued by AGC should be submitted to AGC within 15days after the issuance of the test report. Further enquiry of validity or verification of the test report should be addressed to AGC by agc01@agccert.com.

EN IEC 62368-1			
Clause	Requirement + Test	Result - Remark	Verdict
M.3.3	Compliance	No chemical leakage, no liquid spillage, no explosion, no emission fo flame or expulsion of molten metal	P
<b>M.4</b>	<b>Additional safeguards for equipment containing a portable secondary lithium battery</b>		P
M.4.1	General		P
M.4.2	Charging safeguards		P
M.4.2.1	Requirements		P
M.4.2.2	Compliance..... :		P
M.4.3	Fire enclosure..... :		P
M.4.4	Drop test of equipment containing a secondary lithium battery		P
M.4.4.2	Preparation and procedure for the drop test		P
M.4.4.3	Drop, Voltage on reference and dropped batteries (V); voltage difference during 24 h period (%): ....	After Drop test, the open circuit voltage difference: 0.2% in the 24H.	P
M.4.4.4	Check of the charge/discharge function	Charging and Discharging normally	P
M.4.4.5	Charge / discharge cycle test		P
M.4.4.6	Compliance	No fire, no explosion, and no hazards produced during tests.	P
<b>M.5</b>	<b>Risk of burn due to short-circuit during carrying</b>		P
M.5.1	Requirement	No opening	P
M.5.2	Test method and compliance		N
<b>M.6</b>	<b>Safeguards against short-circuits</b>		P
M.6.1	External and internal faults	No such explosion or fire likely to result from short circuits.	P
M.6.2	Compliance		N
<b>M.7</b>	<b>Risk of explosion from lead acid and NiCd batteries</b>		N
M.7.1	Ventilation preventing explosive gas concentration		N
	Calculated hydrogen generation rate..... :		N
M.7.2	Test method and compliance		N
	Minimum air flow rate, Q (m <sup>3</sup> /h)..... :		N
M.7.3	Ventilation tests		N
M.7.3.1	General		N
M.7.3.2	Ventilation test – alternative 1		N

Any report having not been signed by authorized approver, or having been altered without authorization, or having not been stamped by the “Dedicated Testing/Inspection Stamp” is deemed to be invalid. Copying or excerpting portion of, or altering the content of the report is not permitted without the written authorization of AGC. The test results presented in the report apply only to the tested sample. Any objections to report issued by AGC should be submitted to AGC within 15days after the issuance of the test report. Further enquiry of validity or verification of the test report should be addressed to AGC by agc01@agccert.com.

EN IEC 62368-1			
Clause	Requirement + Test	Result - Remark	Verdict
	Hydrogen gas concentration (%).....:		N
M.7.3.3	Ventilation test – alternative 2		N
	Obtained hydrogen generation rate..... :		N
M.7.3.4	Ventilation test – alternative 3		N
	Hydrogen gas concentration (%).....:		N
M.7.4	Marking.....:		N
<b>M.8</b>	<b>Protection against internal ignition from external spark sources of batteries with aqueous electrolyte</b>		N
M.8.1	General		N
M.8.2	Test method		N
M.8.2.1	General		N
M.8.2.2	Estimation of hypothetical volume $V_z$ (m <sup>3</sup> /s).....:		—
M.8.2.3	Correction factors.....:		—
M.8.2.4	Calculation of distance $d$ (mm) .....:		—
<b>M.9</b>	<b>Preventing electrolyte spillage</b>		N
M.9.1	Protection from electrolyte spillage		N
M.9.2	Tray for preventing electrolyte spillage		N
<b>M.10</b>	<b>Instructions to prevent reasonably foreseeable misuse</b>		P
	Instructional safeguard.....:		N
<b>N</b>	<b>ELECTROCHEMICAL POTENTIALS</b>		N
	Material(s) used..... :		—
<b>O</b>	<b>MEASUREMENT OF CREEPAGE DISTANCES AND CLEARANCES</b>		N
	Value of $X$ (mm)..... :		—
<b>P</b>	<b>SAFEGUARDS AGAINST CONDUCTIVE OBJECTS</b>		N
<b>P.1</b>	<b>General</b>	No opening	N
<b>P.2</b>	<b>Safeguards against entry or consequences of entry of a foreign object</b>		N
P.2.1	General		N
P.2.2	Safeguards against entry of a foreign object		N
	Location and Dimensions (mm) .....:		—
P.2.3	Safeguards against the consequences of entry of a foreign object		N
P.2.3.1	Safeguard requirements		N
	The ES3 and PS3 keep-out volume in Figure P.3 not applicable to transportable equipment		N

Any report having not been signed by authorized approver, or having been altered without authorization, or having not been stamped by the “Dedicated Testing/Inspection Stamp” is deemed to be invalid. Copying or excerpting portion of, or altering the content of the report is not permitted without the written authorization of AGC. The test results presented in the report apply only to the tested sample. Any objections to report issued by AGC should be submitted to AGC within 15days after the issuance of the test report. Further enquiry of validity or verification of the test report should be addressed to AGC by agc01@agccert.com.

EN IEC 62368-1			
Clause	Requirement + Test	Result - Remark	Verdict
	Transportable equipment with metalized plastic parts..... :		N
P.2.3.2	Consequence of entry test..... :		N
<b>P.3</b>	<b>Safeguards against spillage of internal liquids</b>		N
P.3.1	General	No such part.	N
P.3.2	Determination of spillage consequences		N
P.3.3	Spillage safeguards		N
P.3.4	Compliance		N
<b>P.4</b>	<b>Metallized coatings and adhesives securing parts</b>		N
P.4.1	General	No such application	N
P.4.2	Tests		N
	Conditioning, T <sub>c</sub> (°C)..... :		—
	Duration (weeks)..... :		—
<b>Q</b>	<b>CIRCUITS INTENDED FOR INTERCONNECTION WITH BUILDING WIRING</b>		N
<b>Q.1</b>	<b>Limited power sources</b>		N
Q.1.1	Requirements		N
	a) Inherently limited output		N
	b) Impedance limited output		N
	c) Regulating network limited output		N
	d) Overcurrent protective device limited output		N
	e) IC current limiter complying with G.9		N
Q.1.2	Test method and compliance..... :		N
	Current rating of overcurrent protective device (A) ..... :		N
<b>Q.2</b>	<b>Test for external circuits – paired conductor cable</b>	No such circuit.	N
	Maximum output current (A) ..... :		N
	Current limiting method..... :		—
<b>R</b>	<b>LIMITED SHORT CIRCUIT TEST</b>		N
<b>R.1</b>	<b>General</b>	Class III equipment	N
<b>R.2</b>	<b>Test setup</b>		N
	Overcurrent protective device for test..... :		—
<b>R.3</b>	<b>Test method</b>		N
	Cord/cable used for test..... :		—

Any report having not been signed by authorized approver, or having been altered without authorization, or having not been stamped by the “Dedicated Testing/Inspection Stamp” is deemed to be invalid. Copying or excerpting portion of, or altering the content of the report is not permitted without the written authorization of AGC. The test results presented in the report apply only to the tested sample. Any objections to report issued by AGC should be submitted to AGC within 15days after the issuance of the test report. Further enquiry of validity or verification of the test report should be addressed to AGC by agc01@agccert.com.

EN IEC 62368-1			
Clause	Requirement + Test	Result - Remark	Verdict
<b>R.4</b>	<b>Compliance</b>		N
<b>S</b>	<b>TESTS FOR RESISTANCE TO HEAT AND FIRE</b>		N
<b>S.1</b>	<b>Flammability test for fire enclosures and fire barrier materials of equipment where the steady state power does not exceed 4 000 W</b>		N
	Samples, material..... :	Approved material used.	—
	Wall thickness (mm)..... :		—
	Conditioning (°C)..... :		—
	Test flame according to IEC 60695-11-5 with conditions as set out		N
	- Material not consumed completely		N
	- Material extinguishes within 30s		N
	- No burning of layer or wrapping tissue		N
<b>S.2</b>	<b>Flammability test for fire enclosure and fire barrier integrity</b>		
	Samples, material..... :		—
	Wall thickness (mm)..... :		—
	Conditioning (°C)..... :		—
<b>S.3</b>	<b>Flammability test for the bottom of a fire enclosure</b>		N
S.3.1	Mounting of samples		N
S.3.2	Test method and compliance		N
	Mounting of samples ..... :		—
	Wall thickness (mm)..... :		—
<b>S.4</b>	<b>Flammability classification of materials</b>		N
<b>S.5</b>	<b>Flammability test for fire enclosures and fire barrier materials of equipment where the steady state power exceeding 4 000 W</b>		N
	Samples, material..... :		—
	Wall thickness (mm)..... :		—
	Conditioning (°C)..... :		—
<b>T</b>	<b>MECHANICAL STRENGTH TESTS</b>		P
<b>T.1</b>	<b>General</b>		P
<b>T.2</b>	<b>Steady force test, 10 N ..... :</b>		N
<b>T.3</b>	<b>Steady force test, 30 N ..... :</b>		N
<b>T.4</b>	<b>Steady force test, 100 N ..... :</b>	(See appended table T.4)	P
<b>T.5</b>	<b>Steady force test, 250 N ..... :</b>		N
<b>T.6</b>	<b>Enclosure impact test</b>		N

Any report having not been signed by authorized approver, or having been altered without authorization, or having not been stamped by the “Dedicated Testing/Inspection Stamp” is deemed to be invalid. Copying or excerpting portion of, or altering the content of the report is not permitted without the written authorization of AGC. The test results presented in the report apply only to the tested sample. Any objections to report issued by AGC should be submitted to AGC within 15days after the issuance of the test report. Further enquiry of validity or verification of the test report should be addressed to AGC by agc01@agccert.com.



EN IEC 62368-1			
Clause	Requirement + Test	Result - Remark	Verdict
	Fall test		N
	Swing test		N
<b>T.7</b>	<b>Drop test</b> .....	(See appended table T.7)	P
<b>T.8</b>	<b>Stress relief test</b> .....	(See appended table T.8)	P
<b>T.9</b>	<b>Glass Impact Test</b> .....		N
<b>T.10</b>	<b>Glass fragmentation test</b>		N
	Number of particles counted.....	No glass	N
<b>T.11</b>	<b>Test for telescoping or rod antennas</b>		N
	Torque value (Nm) .....	No antenna	N
<b>U</b>	<b>MECHANICAL STRENGTH OF CATHODE RAY TUBES (CRT) AND PROTECTION AGAINST THE EFFECTS OF IMPLOSION</b>		N
<b>U.1</b>	<b>General</b>		N
	Instructional safeguard.....		N
<b>U.2</b>	<b>Test method and compliance for non-intrinsically protected CRTs</b>		N
<b>U.3</b>	<b>Protective screen</b>		N
<b>V</b>	<b>DETERMINATION OF ACCESSIBLE PARTS</b>		N
<b>V.1</b>	<b>Accessible parts of equipment</b>		N
V.1.1	General	No hazards can be accessible by figure V.1 and V.5	N
V.1.2	Surfaces and openings tested with jointed test probes		N
V.1.3	Openings tested with straight unjointed test probes		N
V.1.4	Plugs, jacks, connectors tested with blunt probe		N
V.1.5	Slot openings tested with wedge probe		N
V.1.6	Terminals tested with rigid test wire		N
<b>V.2</b>	<b>Accessible part criterion</b>		N
<b>X</b>	<b>ALTERNATIVE METHOD FOR DETERMINING CLEARANCES FOR INSULATION IN CIRCUITS CONNECTED TO AN AC MAINS NOT EXCEEDING 420 V PEAK (300 V RMS)</b>		N
	Clearance.....		N
<b>Y</b>	<b>CONSTRUCTION REQUIREMENTS FOR OUTDOOR ENCLOSURES</b>		N
<b>Y.1</b>	<b>General</b>		N
<b>Y.2</b>	<b>Resistance to UV radiation</b>		N
<b>Y.3</b>	<b>Resistance to corrosion</b>		N
<b>Y.3</b>	<b>Resistance to corrosion</b>		N

Any report having not been signed by authorized approver, or having been altered without authorization, or having not been stamped by the "Dedicated Testing/Inspection Stamp" is deemed to be invalid. Copying or excerpting portion of, or altering the content of the report is not permitted without the written authorization of AGC. The test results presented in the report apply only to the tested sample. Any objections to report issued by AGC should be submitted to AGC within 15days after the issuance of the test report. Further enquiry of validity or verification of the test report should be addressed to AGC by agc01@agccert.com.

EN IEC 62368-1			
Clause	Requirement + Test	Result - Remark	Verdict
Y.3.1	Metallic parts of outdoor enclosures are resistant to effects of water-borne contaminants by.....:		N
Y.3.2	Test apparatus		N
Y.3.3	Water – saturated sulphur dioxide atmosphere		N
Y.3.4	Test procedure.....:		N
Y.3.5	Compliance		N
<b>Y.4</b>	<b>Gaskets</b>		N
Y.4.1	General		N
Y.4.2	Gasket tests		N
Y.4.3	Tensile strength and elongation tests		N
	Alternative test methods.....:		N
Y.4.4	Compression test		N
Y.4.5	Oil resistance		N
Y.4.6	Securing means		N
<b>Y.5</b>	<b>Protection of equipment within an outdoor enclosure</b>		N
Y.5.1	General		N
Y.5.2	Protection from moisture		N
	Relevant tests of IEC 60529 or Y.5.3.....:		N
Y.5.3	Water spray test		N
Y.5.4	Protection from plants and vermin		N
Y.5.5	Protection from excessive dust		N
Y.5.5.1	General		N
Y.5.5.2	IP5X equipment		N
Y.5.5.3	IP6X equipment		N
<b>Y.6</b>	<b>Mechanical strength of enclosures</b>		N
Y.6.1	General		N
Y.6.2	Impact test.....:		N

Any report having not been signed by authorized approver, or having been altered without authorization, or having not been stamped by the “Dedicated Testing/Inspection Stamp” is deemed to be invalid. Copying or excerpting portion of, or altering the content of the report is not permitted without the written authorization of AGC. The test results presented in the report apply only to the tested sample. Any objections to report issued by AGC should be submitted to AGC within 15days after the issuance of the test report. Further enquiry of validity or verification of the test report should be addressed to AGC by agc01@agccert.com.

EN IEC 62368-1			
Clause	Requirement – Test	Result – Remark	Verdict
ATTACHMENT TO TEST REPORT IEC 62368-1 EUROPEAN GROUP DIFFERENCES AND NATIONAL DIFFERENCES (Audio/video, information and communication technology equipment Part 1: Safety requirements)			
	<b>CENELEC COMMON MODIFICATIONS (EN)</b>		--
	<p>Clause numbers in the cells that are shaded light grey are clause references in EN IEC 62368-1:2020+A11:2020. All other clause numbers in that column, except for those in the paragraph below, refers to IEC 62368-1:2018.</p> <p>Clauses, subclauses, notes, tables, figures and annexes which are additional to those in IEC 62368-1:2018 are prefixed “Z”.</p>		P
	<p>Add the following annexes:</p> <p>Annex ZA (normative) Normative references to international publications with their corresponding European publications</p> <p>Annex ZB (normative) Special national conditions</p> <p>Annex ZC (informative) A-deviations</p> <p>Annex ZD (informative) IEC and CENELEC code designations for flexible cords</p>		P
<b>1</b>	<b>Modification to Clause 3.</b>		N
<b>3.3.19</b>	<b>Sound exposure</b> <i>Replace 3.3.19 of IEC 62368-1 with the following definitions:</i>		N
<b>3.3.19.1</b>	<p><b>momentary exposure level, MEL</b></p> <p>metric for estimating 1 s sound exposure level from the HD 483-1 S2 test signal applied to both channels, based on EN 50332-1:2013, 4.2.</p> <p>Note 1 to entry: MEL is measured as A-weighted levels in dB.</p> <p>Note 2 to entry: See B.3 of EN 50332-3:2017 for additional information.</p>		N
<b>3.3.19.3</b>	<p><b>sound exposure, E</b></p> <p>A-weighted sound pressure (<math>p</math>) squared and integrated over a stated period of time, <math>T</math></p> <p>Note 1 to entry: The SI unit is Pa<sup>2</sup> s.</p> $E = \int_0^T p(t)^2 dt$		N

Any report having not been signed by authorized approver, or having been altered without authorization, or having not been stamped by the “Dedicated Testing/Inspection Stamp” is deemed to be invalid. Copying or excerpting portion of, or altering the content of the report is not permitted without the written authorization of AGC. The test results presented in the report apply only to the tested sample. Any objections to report issued by AGC should be submitted to AGC within 15days after the issuance of the test report. Further enquiry of validity or verification of the test report should be addressed to AGC by agc01@agccert.com.

EN IEC 62368-1			
Clause	Requirement – Test	Result – Remark	Verdict
3.3.19.4	<p><b>sound exposure level, SEL</b></p> <p>logarithmic measure of sound exposure relative to a reference value, <math>E_0</math>, typically the 1 kHz threshold of hearing in humans.</p> <p>Note 1 to entry: <i>SEL</i> is measured as A-weighted levels in dB.</p> $SEL = 10 \lg \left( \frac{E}{E_0} \right) \text{ dB}$ <p>Note 2 to entry: See B.4 of EN 50332-3:2017 for additional information.</p>		N
3.3.19.5	<p><b>digital signal level relative to full scale, dBFS</b></p> <p>levels reported in dBFS are always r.m.s. Full scale level, 0 dBFS, is the level of a dc-free 997-Hz sine wave whose undithered positive peak value is positive digital full scale, leaving the code corresponding to negative digital full scale unused</p> <p>Note 1 to entry: It is invalid to use dBFS for non-r.m.s. levels. Because the definition of full scale is based on a sine wave, the level of signals with a crest factor lower than that of a sine wave may exceed 0 dBFS. In particular, square wave signals may reach +3,01 dBFS.</p>		N
2	<b>Modification to Clause 10</b>		P
10.6	<p><b>Safeguards against acoustic energy sources</b></p> <p>Replace 10.6 of IEC 62368-1 with the following:</p>		P
10.6.1.1	<p><b>Introduction</b></p> <p><b>Safeguard</b> requirements for protection against long-term exposure to excessive sound pressure levels from personal music players closely coupled to the ear are specified below. Requirements for earphones and headphones intended for use with personal music players are also covered. A personal music player is a portable equipment intended for use by an <b>ordinary person</b>, that:</p> <ul style="list-style-type: none"> <li>– is designed to allow the user to listen to audio or audiovisual content / material; and</li> <li>– uses a listening device, such as headphones or earphones that can be worn in or on or around the ears; and</li> <li>– has a player that can be body worn (of a size suitable to be carried in a clothing pocket) and is intended for the user to walk around with while in continuous use (for example, on a street, in a subway, at an airport, etc.).</li> </ul> <p>EXAMPLES Portable CD players, MP3 audio players, mobile phones with MP3 type features, PDAs or similar equipment.</p>		P

Any report having not been signed by authorized approver, or having been altered without authorization, or having not been stamped by the “Dedicated Testing/Inspection Stamp” is deemed to be invalid. Copying or excerpting portion of, or altering the content of the report is not permitted without the written authorization of AGC. The test results presented in the report apply only to the tested sample. Any objections to report issued by AGC should be submitted to AGC within 15days after the issuance of the test report. Further enquiry of validity or verification of the test report should be addressed to AGC by agc01@agccert.com.

EN IEC 62368-1			
Clause	Requirement – Test	Result – Remark	Verdict
	<p>Personal music players shall comply with the requirements of either 10.6.2 or 10.6.3.</p> <p>NOTE 1 Protection against acoustic energy sources from telecom applications is referenced to ITU-T P.360.</p> <p>NOTE 2 It is the intention of the Committee to allow the alternative methods for now, but to only use the dose measurement method as given in 10.6.5 in future. Therefore, manufacturers are encouraged to implement 10.6.5 as soon as possible.</p> <p>Listening devices sold separately shall comply with the requirements of 10.6.6. These requirements are valid for music or video mode only. The requirements do not apply to: – professional equipment;</p> <p>NOTE 3 Professional equipment is equipment sold through special sales channels. All products sold through normal electronics stores are considered not to be professional equipment.</p> <p>– hearing aid equipment and other devices for assistive listening; – the following type of analogue personal music players: • long distance radio receiver (for example, a multiband radio receiver or world band radio receiver, an AM radio receiver), and • cassette player/recorder;</p> <p>NOTE 4 This exemption has been allowed because this technology is falling out of use and it is expected that within a few years it will no longer exist. This exemption will not be extended to other technologies.</p> <p>– a player while connected to an external amplifier that does not allow the user to walk around while in use.</p> <p>For equipment that is clearly designed or intended primarily for use by children, the limits of the relevant toy standards may apply.</p> <p>The relevant requirements are given in EN 71-1:2011, 4.20 and the related tests methods and measurement distances apply.</p>		
<b>10.6.1.2</b>	<p><b>Non-ionizing radiation from radio frequencies in the range 0 to 300 GHz</b></p> <p>The amount of non-ionizing radiation is regulated by European Council Recommendation 1999/519/EC of 12 July 1999 on the limitation of exposure of the general public to electromagnetic fields (0 Hz to 300 GHz). For intentional radiators, ICNIRP guidelines should be</p>		N

Any report having not been signed by authorized approver, or having been altered without authorization, or having not been stamped by the “Dedicated Testing/Inspection Stamp” is deemed to be invalid. Copying or excerpting portion of, or altering the content of the report is not permitted without the written authorization of AGC. The test results presented in the report apply only to the tested sample. Any objections to report issued by AGC should be submitted to AGC within 15days after the issuance of the test report. Further enquiry of validity or verification of the test report should be addressed to AGC by agc01@agccert.com.

EN IEC 62368-1			
Clause	Requirement – Test	Result – Remark	Verdict
	taken into account for Limiting Exposure to Time-Varying Electric, Magnetic, and Electromagnetic Fields (up to 300 GHz). For hand-held and body mounted devices, attention is drawn to EN 50360 and EN 50566.		
<b>10.6.2</b>	<b>Classification of devices without the capacity to estimate sound dose</b>		<b>N</b>
<b>10.6.2.1</b>	<p><b>General</b></p> <p>This standard is transitioning from short-term based (30 s) requirements to long-term based (40 hour) requirements. These clauses remain in effect only for devices that do not comply with sound dose estimation as stipulated in EN 50332-3.</p> <p>For classifying the acoustic output <math>L_{Aeq,T}</math>, measurements are based on the A-weighted equivalent sound pressure level over a 30 s period.</p> <p>For music where the average sound pressure (long term <math>L_{Aeq,T}</math>) measured over the duration of the song is lower than the average produced by the programme simulation noise, measurements may be done over the duration of the complete song. In this case, <math>T</math> becomes the duration of the song.</p> <p>NOTE Classical music, acoustic music and broadcast typically has an average sound pressure (long term <math>L_{Aeq,T}</math>) which is much lower than the average programme simulation noise. Therefore, if the player is capable to analyse the content and compare it with the programme simulation noise, the warning does not need to be given as long as the average sound pressure of the song does not exceed the required limit.</p> <p>For example, if the player is set with the programme simulation noise to 85 dB, but the average music level of the song is only 65 dB, there is no need to give a warning or ask an acknowledgement as long as the average sound level of the song is not above the basic limit of 85 dB.</p>		<b>N</b>
<b>10.6.2.2</b>	<p><b>RS1 limits (to be superseded, see 10.6.3.2)</b></p> <p>RS1 is a class 1 acoustic energy source that does not exceed the following:</p> <ul style="list-style-type: none"> <li>– for equipment provided as a package (player with its listening device), and with a proprietary connector between the player and its listening device, or where the combination of player and listening device is known by other means such as setting or automatic detection, the <math>L_{Aeq,T}</math> acoustic output shall be <math>\leq 85</math> dB when playing the fixed “programme simulation noise” described in EN 50332-1.</li> <li>– for equipment provided with a standardized connector (for example, a 3,5 phone jack) that allows connection to a listening device for general use, the unweighted r.m.s. output voltage shall be <math>\leq 27</math> mV (analogue interface) or <math>-25</math> dBFS (digital interface) when playing the fixed</li> </ul>		<b>N</b>

Any report having not been signed by authorized approver, or having been altered without authorization, or having not been stamped by the “Dedicated Testing/Inspection Stamp” is deemed to be invalid. Copying or excerpting portion of, or altering the content of the report is not permitted without the written authorization of AGC. The test results presented in the report apply only to the tested sample. Any objections to report issued by AGC should be submitted to AGC within 15days after the issuance of the test report. Further enquiry of validity or verification of the test report should be addressed to AGC by agc01@agccert.com.



EN IEC 62368-1			
Clause	Requirement – Test	Result – Remark	Verdict
	“programme simulation noise” described in EN 50332-1. – The RS1 limits will be updated for all devices as per 10.6.3.2.		
<b>10.6.2.3</b>	<b>RS2 limits (to be superseded, see 10.6.3.3)</b>  RS2 is a class 2 acoustic energy source that does not exceed the following: – for equipment provided as a package (player with its listening device), and with a proprietary connector between the player and its listening device, or when the combination of player and listening device is known by other means such as setting or automatic 130 detection, the $L_{Aeq,T}$ acoustic output shall be $\leq 100$ dB(A) when playing the fixed “programme simulation noise” as described in EN 50332-1. – for equipment provided with a standardized connector (for example, a 3,5 phone jack) that allows connection to a listening device for general use, the unweighted r.m.s. output voltage shall be $\leq 150$ mV (analogue interface) or -10 dBFS (digital interface) when playing the fixed “programme simulation noise” as described in EN 50332-1.		N
<b>10.6.3</b>	<b>Classification of devices (new)</b>		N
<b>10.6.3.1</b>	<b>General</b>  Previous limits (10.6.2) created abundant false negative and false positive PMP sound level warnings. New limits, compliant with The Commission Decision of 23 June 2009, are given below.		N
<b>10.6.3.2</b>	<b>RS1 limits (new)</b>  RS1 is a class 1 acoustic energy source that does not exceed the following: – for equipment provided as a package (player with its listening device), and with a proprietary connector between the player and its listening device, or where the combination of player and listening device is known by other means such as setting or automatic detection, the $L_{Aeq,T}$ acoustic output shall be $\leq 80$ dB when playing the fixed “programme simulation noise” described in EN 50332-1. – for equipment provided with a standardized connector (for example, a 3,5 phone jack) that allows connection to a listening device for general use, the unweighted r.m.s. output voltage shall be $\leq 15$ mV (analogue interface) or -30 dBFS (digital interface) when playing the fixed “programme simulation noise” described in EN 50332-1.		N
<b>10.6.3.3</b>	<b>RS2 limits (new)</b>  RS2 is a class 2 acoustic energy source that does not exceed the following: – for equipment provided as a package (player with its		N

Any report having not been signed by authorized approver, or having been altered without authorization, or having not been stamped by the “Dedicated Testing/Inspection Stamp” is deemed to be invalid. Copying or excerpting portion of, or altering the content of the report is not permitted without the written authorization of AGC. The test results presented in the report apply only to the tested sample. Any objections to report issued by AGC should be submitted to AGC within 15days after the issuance of the test report. Further enquiry of validity or verification of the test report should be addressed to AGC by [agc01@agccert.com](mailto:agc01@agccert.com).



EN IEC 62368-1			
Clause	Requirement – Test	Result – Remark	Verdict
	listening device), and with a proprietary connector between the player and its listening device, or where the combination of player and listening device is known by other means such as setting or automatic detection, the weekly sound exposure level, as described in EN 50332-3, shall be $\leq 80$ dB when playing the fixed "programme simulation noise" described in EN 50332-1. – for equipment provided with a standardized connector (for example, a 3,5 phone jack) that allows connection to a listening device for general use, the unweighted r.m.s. output level, integrated over one week, as described in EN50332-3, shall be $\leq 15$ mV (analogue interface) or - 30 dBFS (digital interface) when playing the fixed "programme simulation noise" described in EN 50332-1.		
<b>10.6.4</b>	<b>Requirements for maximum sound exposure</b>		N
<b>10.6.4.1</b>	<b>Measurement methods</b>  All volume controls shall be turned to maximum during tests.  Measurements shall be made in accordance with EN 50332-1 or EN 50332-2 as applicable.		N
<b>10.6.4.2</b>	<b>Protection of persons</b>  Except as given below, protection requirements for parts <b>accessible to ordinary persons, instructed persons and skilled persons</b> are given in 4.3.  NOTE 1 Volume control is not considered a <b>safeguard</b> .  Between RS2 and an <b>ordinary person</b> , the <b>basic safeguard</b> may be replaced by an <b>instructional safeguard</b> in accordance with Clause F.5, except that the <b>instructional safeguard</b> shall be placed on the equipment, or on the packaging, or in the instruction manual. Alternatively, the <b>instructional safeguard</b> may be given through the equipment display during use.  The elements of the <b>instructional safeguard</b> shall be as follows:  – element 1a: the symbol  , IEC 60417-6044 (2011-01) – element 2: "High sound pressure" or equivalent wording – element 3: "Hearing damage risk" or equivalent wording – element 4: "Do not listen at high volume levels for long periods." or equivalent wording  <b>An equipment safeguard shall prevent exposure of an</b>		N

Any report having not been signed by authorized approver, or having been altered without authorization, or having not been stamped by the "Dedicated Testing/Inspection Stamp" is deemed to be invalid. Copying or excerpting portion of, or altering the content of the report is not permitted without the written authorization of AGC. The test results presented in the report apply only to the tested sample. Any objections to report issued by AGC should be submitted to AGC within 15days after the issuance of the test report. Further enquiry of validity or verification of the test report should be addressed to AGC by agc01@agccert.com.

EN IEC 62368-1			
Clause	Requirement – Test	Result – Remark	Verdict
	<p><b>ordinary person</b> to an RS2 source without intentional physical action from the <b>ordinary person</b> and shall automatically return to an output level not exceeding what is specified for an RS1 source when the power is switched off.</p> <p>The equipment shall provide a means to actively inform the user of the increased sound level when the equipment is operated with an output exceeding RS1. Any means used shall be acknowledged by the user before activating a mode of operation which allows for an output exceeding RS1. The acknowledgement does not need to be repeated more than once every 20 h of cumulative listening time.</p> <p>NOTE 2 Examples of means include visual or audible signals. Action from the user is always needed.</p> <p>NOTE 3 The 20 h listening time is the accumulative listening time, independent of how often and how long the personal music player has been switched off.</p> <p>A <b>skilled person</b> shall not be unintentionally exposed to RS3.</p>		
<b>10.6.5</b>	<b>Requirements for dose-based systems</b>		<b>N</b>
<b>10.6.5.1</b>	<p><b>General requirements</b></p> <p>Personal music players shall give the warnings as provided below when tested according to EN 50332-3, using the limits from this clause.</p> <p>The manufacturer may offer optional settings to allow the users to modify when and how they wish to receive the notifications and warnings to promote a better user experience without defeating the safeguards. This allows the users to be informed in a method that best meets their physical capabilities and device usage needs. If such optional settings are offered, an administrator (for example, parental restrictions, business/educational administrators, etc.) shall be able to lock any optional settings into a specific configuration.</p> <p>The personal music player shall be supplied with easy to understand explanation to the user of the dose management system, the risks involved, and how to use the system safely. The user shall be made aware that other sources may significantly contribute to their sound exposure, for example work, transportation, concerts, clubs, cinema, car races, etc.</p>		<b>N</b>
<b>10.6.5.2</b>	<p><b>Dose-based warning and requirements</b></p> <p>When a dose of 100 % <i>CSD</i> is reached, and at least at every 100 % further increase of <i>CSD</i>, the device shall</p>		<b>N</b>

Any report having not been signed by authorized approver, or having been altered without authorization, or having not been stamped by the “Dedicated Testing/Inspection Stamp” is deemed to be invalid. Copying or excerpting portion of, or altering the content of the report is not permitted without the written authorization of AGC. The test results presented in the report apply only to the tested sample. Any objections to report issued by AGC should be submitted to AGC within 15days after the issuance of the test report. Further enquiry of validity or verification of the test report should be addressed to AGC by agc01@agccert.com.

EN IEC 62368-1			
Clause	Requirement – Test	Result – Remark	Verdict
	<p>warn the user and require an acknowledgement. In case the user does not acknowledge, the output level shall automatically decrease to compliance with class RS1.</p> <p>The warning shall at least clearly indicate that listening above 100 % <i>CSD</i> leads to the risk of hearing damage or loss.</p>		
<b>10.6.5.3</b>	<p><b>Exposure-based requirements</b></p> <p>With only dose-based requirements, cause and effect could be far separated in time, defying the purpose of educating users about safe listening practice. In addition to dose-based requirements, a PMP shall therefore also put a limit to the short-term sound level a user can listen at.</p> <p>The exposure-based limiter (EL) shall automatically reduce the sound level not to exceed 100 dB(A) or 150 mV integrated over the past 180 s, based on methodology defined in EN 50332-3.</p> <p>The EL settling time (time from starting level reduction to reaching target output) shall be 10 s or faster.</p> <p>Test of EL functionality is conducted according to EN 50332-3, using the limits from this clause. For equipment provided as a package (player with its listening device), the level integrated over 180 s shall be 100 dB or lower. For equipment provided with a standardized connector, the unweighted level integrated over 180 s shall be no more than 150 mV for an analogue interface and no more than -10 dBFS for a digital interface.</p> <p>NOTE In case the source is known not to be music (or test signal), the EL may be disabled.</p>		N
<b>10.6.6</b>	<b>Requirements for listening devices (headphones, earphones, etc.)</b>		P
<b>10.6.6.1</b>	<p><b>Corded listening devices with analogue input</b></p> <p>With 94 dB <i>L<sub>Aeq</sub></i> acoustic pressure output of the listening device, and with the volume and sound settings in the listening device (for example, built-in volume level control, additional sound features like equalization, etc.) set to the combination of positions that maximize the measured acoustic output, the input voltage of the listening device when playing the fixed “programme simulation noise” as described in EN 50332-1 shall be <math>\geq 75</math> mV.</p> <p>NOTE The values of 94 dB and 75 mV correspond with 85 dB and 27 mV or 100 dB and 150 mV.</p>		N
<b>10.6.6.2</b>	<p><b>Corded listening devices with digital input</b></p> <p>With any playing device playing the fixed “programme</p>		N

Any report having not been signed by authorized approver, or having been altered without authorization, or having not been stamped by the “Dedicated Testing/Inspection Stamp” is deemed to be invalid. Copying or excerpting portion of, or altering the content of the report is not permitted without the written authorization of AGC. The test results presented in the report apply only to the tested sample. Any objections to report issued by AGC should be submitted to AGC within 15days after the issuance of the test report. Further enquiry of validity or verification of the test report should be addressed to AGC by agc01@agccert.com.

EN IEC 62368-1			
Clause	Requirement – Test	Result – Remark	Verdict
	simulation noise” described in EN 50332-1, and with the volume and sound settings in the listening device (for example, built-in volume level control, additional sound features like equalization, etc.) set to the combination of positions that maximize the measured acoustic output, the $L_{Aeq,T}$ acoustic output of the listening device shall be $\leq 100$ dB with an input signal of -10 dBFS.		
<b>10.6.6.3</b>	<p><b>Cordless listening devices</b></p> <p>In cordless mode,</p> <ul style="list-style-type: none"> <li>– with any playing and transmitting device playing the fixed programme simulation noise described in EN 50332-1; and</li> <li>– respecting the cordless transmission standards, where an air interface standard exists that specifies the equivalent acoustic level; and</li> <li>– with volume and sound settings in the receiving device (for example, built-in volume level control, additional sound features like equalization, etc.) set to the combination of positions that maximize the measured acoustic output for the above mentioned programme simulation noise, the <math>L_{Aeq,T}</math> acoustic output of the listening device shall be <math>\leq 100</math> dB with an input signal of -10 dBFS.</li> </ul>		P
<b>10.6.6.4</b>	<p><b>Measurement method</b></p> <p><i>Measurements shall be made in accordance with EN 50332-2 as applicable.</i></p>		P
<b>3</b>	<b>Modification to the whole document</b>		P
	<b>Delete</b> all the “country” notes in the reference document according to the following list:		P

Any report having not been signed by authorized approver, or having been altered without authorization, or having not been stamped by the “Dedicated Testing/Inspection Stamp” is deemed to be invalid. Copying or excerpting portion of, or altering the content of the report is not permitted without the written authorization of AGC. The test results presented in the report apply only to the tested sample. Any objections to report issued by AGC should be submitted to AGC within 15days after the issuance of the test report. Further enquiry of validity or verification of the test report should be addressed to AGC by agc01@agccert.com.

EN IEC 62368-1							
Clause	Requirement – Test				Result – Remark		Verdict
	0.2.1	Note 1 and 2	1	Note 4 and 5	3.3.8.1	Note 2	
	3.3.8.3	Note 1	4.1.15	Note	4.7.3	Note 1 and 2	
	5.2.2.2	Note	5.4.2.3.2.2 Table 12	Note c	5.4.2.3.2.4	Note 1 and 3	
	5.4.2.3.2.4 Table 13	Note 2	5.4.2.5	Note 2	5.4.5.1	Note	
	5.4.10.2.1	Note	5.4.10.2.2	Note	5.4.10.2.3	Note	
	5.5.2.1	Note	5.5.6	Note	5.6.4.2.1	Note 2 and 3 and 4	
	5.6.8	Note 2	5.7.6	Note	5.7.7.1	Note 1 and Note 2	
	8.5.4.2.3	Note	10.2.1 Table 39	Note 3 and 4 and 5	10.5.3	Note 2	
	40.6.1	Note 3	F.3.3.6	Note 3	Y.4.1	Note	
	Y.4.5	Note					
<b>4</b>	<b>Modification to Clause 1</b>						<b>P</b>
<b>1</b>	<b>Add the following note:</b>  <i>NOTE Z1 The use of certain substances in electrical and electronic equipment is restricted within the EU: see Directive 2011/65/EU.</i>						<b>P</b>
<b>5</b>	<b>Modification to 4.Z1</b>						<b>N</b>
<b>4.Z1</b>	<b>Add the following new subclause after 4.9:</b>  To protect against excessive current, short-circuits and earth faults in circuits connected to an a.c. <b>mains</b> , protective devices shall be included either as integral parts of the equipment or as parts of the building installation, subject to the following, a), b) and c): a) except as detailed in b) and c), protective devices necessary to comply with the requirements of B.3.1 and B.4 shall be included as parts of the equipment; b) for components in series with the mains input to the equipment such as the supply cord, appliance coupler, r.f.i. filter and switch, short-circuit and earth fault protection may be provided by protective devices in the building installation; c) it is permitted for <b>pluggable equipment type B</b> or <b>permanently connected equipment</b> , to rely on dedicated overcurrent and short-circuit protection in the building installation, provided that the means of						<b>N</b>

Any report having not been signed by authorized approver, or having been altered without authorization, or having not been stamped by the “Dedicated Testing/Inspection Stamp” is deemed to be invalid. Copying or excerpting portion of, or altering the content of the report is not permitted without the written authorization of AGC. The test results presented in the report apply only to the tested sample. Any objections to report issued by AGC should be submitted to AGC within 15days after the issuance of the test report. Further enquiry of validity or verification of the test report should be addressed to AGC by agc01@agccert.com.

EN IEC 62368-1			
Clause	Requirement – Test	Result – Remark	Verdict
	<p>protection, e.g. fuses or circuit breakers, is fully specified in the installation instructions.</p> <p>If reliance is placed on protection in the building installation, the installation instructions shall so state, except that for <b>pluggable equipment type A</b> the building installation shall be regarded as providing protection in accordance with the rating of the wall socket outlet.</p>		
<b>6</b>	<b>Modification to 5.4.2.3.2.4</b>		<b>N</b>
<b>5.4.2.3.2.4</b>	<p><i>Add the following to the end of this subclause:</i></p> <p>The requirement for interconnection with <b>external circuit</b> is in addition given in EN 50491-3:2009.</p>		<b>N</b>
<b>7</b>	<b>Modification to 10.2.1</b>		<b>N</b>
<b>10.2.1</b>	<p>Add the following to <sup>c)</sup> and <sup>d)</sup> in table 39:</p> <p>For additional requirements, see 10.5.1.</p>		<b>N</b>
<b>8</b>	<b>Modification to 10.5.1</b>		<b>N</b>
<b>10.5.1</b>	<p><i>Add the following after the first paragraph:</i></p> <p>For RS1 compliance is checked by measurement under the following conditions:</p> <p>In addition to the normal operating conditions, all controls adjustable from the outside by hand, by any object such as a tool or a coin, and those internal adjustments or pre-sets which are not locked in a reliable manner, are adjusted so as to give maximum radiation whilst maintaining an intelligible picture for 1 h, at the end of which the measurement is made.</p> <p>NOTE Z1 Soldered joints and paint lockings are examples of adequate locking.</p> <p>The dose-rate is determined by means of a radiation monitor with an effective area of 10 cm<sup>2</sup>, at any point 10 cm from the outer surface of the apparatus.</p> <p>Moreover, the measurement shall be made under fault conditions causing an increase of the high voltage, provided an intelligible picture is maintained for 1 h, at the end of which the measurement is made.</p> <p>For RS1, the dose-rate shall not exceed 1 µSv/h taking account of the background level.</p> <p>NOTE Z2 These values appear in Directive 96/29/Euratom of 13 May 1996.</p>		<b>N</b>
<b>9</b>	<b>Modification to G.7.1</b>		<b>N</b>

Any report having not been signed by authorized approver, or having been altered without authorization, or having not been stamped by the “Dedicated Testing/Inspection Stamp” is deemed to be invalid. Copying or excerpting portion of, or altering the content of the report is not permitted without the written authorization of AGC. The test results presented in the report apply only to the tested sample. Any objections to report issued by AGC should be submitted to AGC within 15days after the issuance of the test report. Further enquiry of validity or verification of the test report should be addressed to AGC by agc01@agccert.com.



EN IEC 62368-1			
Clause	Requirement – Test	Result – Remark	Verdict
<b>G.7.1</b>	<b>Add the following note:</b>  NOTE Z1 The harmonized code designations corresponding to the IEC cord types are given in Annex ZD.		N
<b>10</b>	<b>Modification to Bibliography</b>		N
	<b>Add the following notes for the standards indicated:</b>  IEC 60130-9 NOTE Harmonized as EN 60130-9. IEC 60289-2 NOTE Harmonized as HD 60289-2. IEC 60309-1 NOTE Harmonized as EN 60309-1. IEC 60364 NOTE some parts harmonized in HD 3 IEC 60601-2-4 NOTE Harmonized as EN 60601-2-4. IEC 60664-5 NOTE Harmonized as EN 60664-5. IEC 61032:1997 NOTE Harmonized as EN 61032:1998 IEC 61508-1 NOTE Harmonized as EN 61508-1. IEC 61558-2-1 NOTE Harmonized as EN 61558-2-1. IEC 61558-2-4 NOTE Harmonized as EN 61558-2-4. IEC 61558-2-6 NOTE Harmonized as EN 61558-2-6. IEC 61643-1 NOTE Harmonized as EN 61643-1. IEC 61643-21 NOTE Harmonized as EN 61643-21. IEC 61643-311 NOTE Harmonized as EN 61643-311. IEC 61643-321 NOTE Harmonized as EN 61643-321. IEC 61643-331 NOTE Harmonized as EN 61643-331.		N
<b>11</b>	<b>ADDITION OF ANNEXES</b>		N
<b>ZB</b>	<b>ANNEX ZB, SPECIAL NATIONAL CONDITIONS (EN)</b>		N
<b>4.1.15</b>	<b>Denmark, Finland, Norway and Sweden</b>  To the end of the subclause the following is added: <b>Class I pluggable equipment type A</b> intended for connection to other equipment or a network shall, if safety relies on connection to reliable earthing or if surge suppressors are connected between the network terminals and <b>accessible</b> parts, have a marking stating that the equipment shall be connected to an earthed <b>mains</b> socket-outlet.  The marking text in the applicable countries shall be as follows:  In <b>Denmark</b> : "Apparatets stikprop skal tilsluttes en stikkontakt med jord som giver forbindelse til stikproppens jord." In <b>Finland</b> : "Laitte on liitettävä suojakoskettimilla varustettuun pistorasiaan" In <b>Norway</b> : "Apparatet må tilkoples jordet stikkontakt" In <b>Sweden</b> : "Apparaten skall anslutas till jordat uttag"		N
<b>4.7.3</b>	<b>United Kingdom</b>		N

Any report having not been signed by authorized approver, or having been altered without authorization, or having not been stamped by the "Dedicated Testing/Inspection Stamp" is deemed to be invalid. Copying or excerpting portion of, or altering the content of the report is not permitted without the written authorization of AGC. The test results presented in the report apply only to the tested sample. Any objections to report issued by AGC should be submitted to AGC within 15days after the issuance of the test report. Further enquiry of validity or verification of the test report should be addressed to AGC by agc01@agccert.com.



EN IEC 62368-1			
Clause	Requirement – Test	Result – Remark	Verdict
	<p>To the end of the subclause the following is added:</p> <p>The torque test is performed using a socket-outlet complying with BS 1363, and the plug part shall be assessed to the relevant clauses of BS 1363. Also see Annex G.4.2 of this annex</p>		
<b>5.2.2.2</b>	<p><b>Denmark</b></p> <p>After the 2nd paragraph add the following:</p> <p>A warning (marking safeguard) for high touch current is required if the touch current exceeds the limits of 3,5 mA a.c. or 10 mA d.c.</p>		N
<b>5.4.11.1 and Annex G</b>	<p><b>Finland and Sweden</b></p> <p>To the end of the subclause the following is added:</p> <p>For separation of the telecommunication network from earth the following is applicable:</p> <p>If this insulation is solid, including insulation forming part of a component, it shall at least consist of either</p> <ul style="list-style-type: none"> <li>• two layers of thin sheet material, each of which shall pass the electric strength test below, or</li> <li>• one layer having a distance through insulation of at least 0,4 mm, which shall pass the electric strength test below.</li> </ul> <p>If this insulation forms part of a semiconductor component (e.g. an optocoupler), there is no distance through insulation requirement for the insulation consisting of an insulating compound completely filling the casing, so that clearances and creepage distances do not exist, if the component passes the electric strength test in accordance with the compliance clause below and in addition</p> <ul style="list-style-type: none"> <li>• passes the tests and inspection criteria of 5.4.8 with an electric strength test of 1,5 kV multiplied by 1,6 (the electric strength test of 5.4.9 shall be performed using 1,5 kV),</li> </ul> <p>and</p> <ul style="list-style-type: none"> <li>• is subject to routine testing for electric strength during manufacturing, using a test voltage of 1,5 kV.</li> </ul> <p>It is permitted to bridge this insulation with a capacitor complying with EN 60384-14:2005, subclass Y2.</p>		N

Any report having not been signed by authorized approver, or having been altered without authorization, or having not been stamped by the "Dedicated Testing/Inspection Stamp" is deemed to be invalid. Copying or excerpting portion of, or altering the content of the report is not permitted without the written authorization of AGC. The test results presented in the report apply only to the tested sample. Any objections to report issued by AGC should be submitted to AGC within 15days after the issuance of the test report. Further enquiry of validity or verification of the test report should be addressed to AGC by agc01@agccert.com.

EN IEC 62368-1			
Clause	Requirement – Test	Result – Remark	Verdict
	<p>A capacitor classified Y3 according to EN 60384-14:2005, may bridge this insulation under the following conditions:</p> <ul style="list-style-type: none"> <li>the insulation requirements are satisfied by having a capacitor classified Y3 as defined by EN 60384-14, which in addition to the Y3 testing, is tested with an impulse test of 2,5 kV defined in 5.4.11;</li> <li>the additional testing shall be performed on all the test specimens as described in EN 60384-14;</li> </ul> <p>the impulse test of 2,5 kV is to be performed before the endurance test in EN 60384-14, in the sequence of tests as described in EN 60384-14.</p>		
5.5.2.1	<p><b>Norway</b></p> <p>After the 3rd paragraph the following is added:</p> <p>Due to the IT power system used, capacitors are required to be rated for the applicable line-to-line voltage (230 V).</p>		N
5.5.6	<p><b>Finland, Norway and Sweden</b></p> <p>To the end of the subclause the following is added:</p> <p>Resistors used as <b>basic safeguard</b> or bridging <b>basic insulation in class I pluggable equipment type A</b> shall comply with G.10.1 and the test of G.10.2.</p>		N
5.6.1	<p><b>Denmark</b></p> <p><b>Add</b> to the end of the subclause Due to many existing installations where the socket-outlets can be protected with fuses with higher rating than the rating of the socket-outlets the protection for pluggable equipment type A shall be an integral part of the equipment. <i>Justification:</i> In Denmark an existing 13 A socket outlet can be protected by a 20 A fuse.</p>		N
5.6.4.2.1	<p><b>Ireland and United Kingdom</b></p> <p>After the indent for <b>pluggable equipment type A</b>, the following is added: – the <b>protective current rating</b> is taken to be 13 A, this being the largest rating of fuse used in the <b>mains</b> plug.</p>		N
5.6.4.2.1	<p><b>France</b></p> <p>After the indent for <b>pluggable equipment type A</b>, the following is added: – in certain cases, the <b>protective current rating</b> of the</p>		N

Any report having not been signed by authorized approver, or having been altered without authorization, or having not been stamped by the “Dedicated Testing/Inspection Stamp” is deemed to be invalid. Copying or excerpting portion of, or altering the content of the report is not permitted without the written authorization of AGC. The test results presented in the report apply only to the tested sample. Any objections to report issued by AGC should be submitted to AGC within 15days after the issuance of the test report. Further enquiry of validity or verification of the test report should be addressed to AGC by agc01@agccert.com.

EN IEC 62368-1			
Clause	Requirement – Test	Result – Remark	Verdict
	circuit supplied from the mains is taken as 20 A instead of 16 A.		
<b>5.6.5.1</b>	To the second paragraph the following is added:  The range of conductor sizes of flexible cords to be accepted by terminals for equipment with a rated current over 10 A and up to and including 13 A is: 1,25 mm <sup>2</sup> to 1,5 mm <sup>2</sup> in cross-sectional area.		N
<b>5.6.8</b>	<b>Norway</b>  To the end of the subclause the following is added: Equipment connected with an earthed mains plug is classified as <b>class I equipment</b> . See the Norway marking requirement in 4.1.15. The symbol IEC 60417-6092, as specified in F.3.6.2, is accepted.		N
<b>5.7.6</b>	<b>Denmark</b>  To the end of the subclause the following is added:  The installation instruction shall be affixed to the equipment if the <b>protective conductor current</b> exceeds the limits of 3,5 mA a.c. or 10 mA d.c.		N
<b>5.7.6.2</b>	<b>Denmark</b>  To the end of the subclause the following is added: The warning (marking safeguard) for high touch current is required if the touch current or the protective current exceed the limits of 3,5 mA .		N
<b>5.7.7.1</b>	<b>Norway and Sweden</b>  To the end of the subclause the following is added: The screen of the television distribution system is normally not earthed at the entrance of the building and there is normally no equipotential bonding system within the building. Therefore the protective earthing of the building installation needs to be isolated from the screen of a cable distribution system.  It is however accepted to provide the insulation external to the equipment by an adapter or an interconnection cable with galvanic isolator, which may be provided by a retailer, for example.  The user manual shall then have the following or similar information in Norwegian and Swedish language respectively, depending on in what country the equipment is intended to be used in:  “Apparatus connected to the protective earthing of the building installation through the mains connection or through other apparatus with a connection to protective		N

Any report having not been signed by authorized approver, or having been altered without authorization, or having not been stamped by the “Dedicated Testing/Inspection Stamp” is deemed to be invalid. Copying or excerpting portion of, or altering the content of the report is not permitted without the written authorization of AGC. The test results presented in the report apply only to the tested sample. Any objections to report issued by AGC should be submitted to AGC within 15days after the issuance of the test report. Further enquiry of validity or verification of the test report should be addressed to AGC by agc01@agccert.com.

EN IEC 62368-1			
Clause	Requirement – Test	Result – Remark	Verdict
	<p>earthing – and to a television distribution system using coaxial cable, may in some circumstances create a fire hazard. Connection to a television distribution system therefore has to be provided through a device providing electrical isolation below a certain frequency range (galvanic isolator, see EN 60728-11)”</p> <p>NOTE In Norway, due to regulation for CATV-installations, and in Sweden, a galvanic isolator shall provide electrical insulation below 5 MHz. The insulation shall withstand a dielectric strength of 1,5 kV r.m.s., 50 Hz or 60 Hz, for 1 min.</p> <p>Translation to Norwegian (the Swedish text will also be accepted in Norway):</p> <p>“Apparater som er koplet til beskyttelsesjord via nettplugg og/eller via annet jordtilkoplet utstyr – og er tilkoplet et koaksialbasert kabel-TV nett, kan forårsake brannfare. For å unngå dette skal det ved tilkopling av apparater til kabel-TV nett installeres en galvanisk isolator mellom apparatet og kabel-TV nettet.”</p> <p>Translation to Swedish: ”Apparater som är kopplad till skyddsjord via jordat vägguttag och/eller via annan utrustning och samtidigt är kopplad till kabel-TV nät kan i vissa fall medföra risk för brand. För att undvika detta skall vid anslutning av apparaten till kabel-TV nät galvanisk isolator finnas mellan apparaten och kabel-TV nätet.”.</p>		
<b>8.5.4.2.3</b>	<p><b>United Kingdom</b></p> <p>Add the following after the 2<sup>nd</sup> dash bullet in 3<sup>rd</sup> paragraph:</p> <p>An emergency stop system complying with the requirements of IEC 60204-1 and ISO 13850 is required where there is a risk of personal injury.</p>		N
<b>B.3.1 and B.4</b>	<p><b>Ireland and United Kingdom</b></p> <p>The following is applicable:</p> <p>To protect against excessive currents and short-circuits in the primary circuit of <b>direct plug-in equipment</b>, tests according to Annexes B.3.1 and B.4 shall be conducted using an external miniature circuit breaker complying with EN 60898-1, Type B, rated 32A. If the equipment does not pass these tests, suitable protective devices shall be included as an integral part of the <b>direct plug-in equipment</b>, until the requirements of Annexes B.3.1 and B.4 are met</p>		N
<b>G.4.2</b>	<p><b>Denmark</b></p>		N

Any report having not been signed by authorized approver, or having been altered without authorization, or having not been stamped by the “Dedicated Testing/Inspection Stamp” is deemed to be invalid. Copying or excerpting portion of, or altering the content of the report is not permitted without the written authorization of AGC. The test results presented in the report apply only to the tested sample. Any objections to report issued by AGC should be submitted to AGC within 15days after the issuance of the test report. Further enquiry of validity or verification of the test report should be addressed to AGC by agc01@agccert.com.

EN IEC 62368-1			
Clause	Requirement – Test	Result – Remark	Verdict
	<p>To the end of the subclause the following is added:</p> <p>Supply cords of single phase appliances having a rated current not exceeding 13 A shall be provided with a plug according to DS 60884-2-D1:2011.</p> <p>CLASS I EQUIPMENT provided with socket-outlets with earth contacts or which are intended to be used in locations where protection against indirect contact is required according to the wiring rules shall be provided with a plug in accordance with standard sheet DK 2-1a or DK 2-5a.</p> <p>If a single-phase equipment having a RATED CURRENT exceeding 13 A or if a polyphase equipment is provided with a supply cord with a plug, this plug shall be in accordance with the standard sheets DK 6-1a in DS 60884-2-D1 or EN 60309-2.</p> <p>Mains socket outlets intended for providing power to Class II apparatus with a rated current of 2,5 A shall be in accordance DS 60884-2-D1:2011 standard sheet DKA 1-4a.</p> <p>Other current rating socket outlets shall be in compliance with Standard Sheet DKA 1-3a or DKA 1-1c.</p> <p>Mains socket-outlets with earth shall be in compliance with DS 60884-2-D1:2011 Standard Sheet DK 1-3a, DK 1-1c, DK1-1d, DK 1-5a or DK 1-7a</p> <p><i>Justification:</i> Heavy Current Regulations, Section 6c</p>		
<b>G.4.2</b>	<p><b>United Kingdom</b></p> <p>To the end of the subclause the following is added:</p> <p>The plug part of direct plug-in equipment shall be assessed to BS 1363: Part 1, 12.1, 12.2, 12.3, 12.9, 12.11, 12.12, 12.13, 12.16, and 12.17, except that the test of 12.17 is performed at not less than 125 °C. Where the metal earth pin is replaced by an Insulated Shutter Opening Device (ISOD), the requirements of clauses 22.2 and 23 also apply.</p>		<b>N</b>
<b>G.7.1</b>	<p><b>United Kingdom</b></p> <p>To the first paragraph the following is added:</p> <p>Equipment which is fitted with a flexible cable or cord and is designed to be connected to a mains socket</p>		<b>N</b>

Any report having not been signed by authorized approver, or having been altered without authorization, or having not been stamped by the "Dedicated Testing/Inspection Stamp" is deemed to be invalid. Copying or excerpting portion of, or altering the content of the report is not permitted without the written authorization of AGC. The test results presented in the report apply only to the tested sample. Any objections to report issued by AGC should be submitted to AGC within 15days after the issuance of the test report. Further enquiry of validity or verification of the test report should be addressed to AGC by agc01@agccert.com.

EN IEC 62368-1			
Clause	Requirement – Test	Result – Remark	Verdict
	<p>conforming to BS 1363 by means of that flexible cable or cord shall be fitted with a 'standard plug' in accordance with the Plugs and Sockets etc. (Safety) Regulations 1994, Statutory Instrument 1994 No. 1768, unless exempted by those regulations.</p> <p>NOTE "Standard plug" is defined in SI 1768:1994 and essentially means an approved plug conforming to BS 1363 or an approved conversion plug.</p>		
<b>G.7.1</b>	<p><b>Ireland</b></p> <p>To the first paragraph the following is added:</p> <p>Apparatus which is fitted with a flexible cable or cord shall be provided with a plug in accordance with Statutory Instrument 525: 1997, "13 A Plugs and Conversion Adapters for Domestic Use Regulations: 1997. S.I. 525 provides for the recognition of a standard of another Member State which is equivalent to the relevant Irish Standard</p>		<b>N</b>
<b>G.7.2</b>	<p><b>Ireland and United Kingdom</b></p> <p>To the first paragraph the following is added:</p> <p>A power supply cord with a conductor of 1,25 mm<sup>2</sup> is allowed for equipment which is rated over 10 A and up to and including 13 A.</p>		<b>N</b>

<b>ZC</b>	<b>ANNEX ZC, NATIONAL DEVIATIONS (EN)</b>		<b>N</b>
<b>10.5.2</b>	<p><b>Germany</b></p> <p>The following requirement applies:</p> <p>For the operation of any cathode ray tube intended for the display of visual images operating at an acceleration voltage exceeding 40 kV, authorization is required, or application of type approval (Bauartzulassung) and marking.</p> <p><i>Justification:</i> German ministerial decree against ionizing radiation (Röntgenverordnung), in force since 2002-07-01, implementing the European Directive 96/29/EURATOM.</p> <p><b>NOTE</b> Contact address: Physikalisch-Technische Bundesanstalt, Bundesallee 100, D-38116 Braunschweig, Tel.: Int+49-531-592-6320, Internet: <a href="http://www.ptb.de">http://www.ptb.de</a></p>		<b>N</b>

Any report having not been signed by authorized approver, or having been altered without authorization, or having not been stamped by the "Dedicated Testing/Inspection Stamp" is deemed to be invalid. Copying or excerpting portion of, or altering the content of the report is not permitted without the written authorization of AGC. The test results presented in the report apply only to the tested sample. Any objections to report issued by AGC should be submitted to AGC within 15days after the issuance of the test report. Further enquiry of validity or verification of the test report should be addressed to AGC by [agc01@agccert.com](mailto:agc01@agccert.com).



EN IEC 62368-1																																																							
Clause	Requirement – Test	Result – Remark	Verdict																																																				
ZD	<b>IEC and CENELEC CODE DESIGNATIONS FOR FLEXIBLE CORDS (EN)</b>		N																																																				
	<table border="1"> <thead> <tr> <th rowspan="2">Type of flexible cord</th> <th colspan="2">Code designations</th> </tr> <tr> <th>IEC</th> <th>CENELEC</th> </tr> </thead> <tbody> <tr> <td colspan="3"><b>PVC insulated cords</b></td> </tr> <tr> <td>Flat twin tinsel cord</td> <td>60227 IEC 41</td> <td>H03VH-Y</td> </tr> <tr> <td>Light polyvinyl chloride sheathed flexible cord</td> <td>60227 IEC 52</td> <td>H03VV-F H03VVH2-F</td> </tr> <tr> <td>Ordinary polyvinyl chloride sheathed flexible cord</td> <td>60227 IEC 53</td> <td>H05VV-F H05VVH2-F</td> </tr> <tr> <td colspan="3"><b>Rubber insulated cords</b></td> </tr> <tr> <td>Braided cord</td> <td>60245 IEC 51</td> <td>H03RT-F</td> </tr> <tr> <td>Ordinary tough rubber sheathed flexible cord</td> <td>60245 IEC 53</td> <td>H05RR-F</td> </tr> <tr> <td>Ordinary polychloroprene sheathed flexible cord</td> <td>60245 IEC 57</td> <td>H05RN-F</td> </tr> <tr> <td>Heavy polychloroprene sheathed flexible cord</td> <td>60245 IEC 66</td> <td>H07RN-F</td> </tr> <tr> <td colspan="3"><b>Cords having high flexibility</b></td> </tr> <tr> <td>Rubber insulated and sheathed cord</td> <td>60245 IEC 86</td> <td>H03RR-H</td> </tr> <tr> <td>Rubber insulated, crosslinked PVC sheathed cord</td> <td>60245 IEC 87</td> <td>H03RV4-H</td> </tr> <tr> <td>Crosslinked PVC insulated and sheathed cord</td> <td>60245 IEC 88</td> <td>H03V4V4-H</td> </tr> <tr> <td colspan="3"><b>Cords insulated and sheathed with halogen-free thermoplastic compounds</b></td> </tr> <tr> <td>Light halogen-free thermoplastic insulated and sheathed flexible cords</td> <td></td> <td>H03Z1Z1-F H03Z1Z1H2-F</td> </tr> <tr> <td>Ordinary halogen-free thermoplastic insulated and sheathed flexible cords</td> <td></td> <td>H05Z1Z1-F H05Z1Z1H2-F</td> </tr> </tbody> </table>	Type of flexible cord	Code designations		IEC	CENELEC	<b>PVC insulated cords</b>			Flat twin tinsel cord	60227 IEC 41	H03VH-Y	Light polyvinyl chloride sheathed flexible cord	60227 IEC 52	H03VV-F H03VVH2-F	Ordinary polyvinyl chloride sheathed flexible cord	60227 IEC 53	H05VV-F H05VVH2-F	<b>Rubber insulated cords</b>			Braided cord	60245 IEC 51	H03RT-F	Ordinary tough rubber sheathed flexible cord	60245 IEC 53	H05RR-F	Ordinary polychloroprene sheathed flexible cord	60245 IEC 57	H05RN-F	Heavy polychloroprene sheathed flexible cord	60245 IEC 66	H07RN-F	<b>Cords having high flexibility</b>			Rubber insulated and sheathed cord	60245 IEC 86	H03RR-H	Rubber insulated, crosslinked PVC sheathed cord	60245 IEC 87	H03RV4-H	Crosslinked PVC insulated and sheathed cord	60245 IEC 88	H03V4V4-H	<b>Cords insulated and sheathed with halogen-free thermoplastic compounds</b>			Light halogen-free thermoplastic insulated and sheathed flexible cords		H03Z1Z1-F H03Z1Z1H2-F	Ordinary halogen-free thermoplastic insulated and sheathed flexible cords		H05Z1Z1-F H05Z1Z1H2-F	N
Type of flexible cord	Code designations																																																						
	IEC	CENELEC																																																					
<b>PVC insulated cords</b>																																																							
Flat twin tinsel cord	60227 IEC 41	H03VH-Y																																																					
Light polyvinyl chloride sheathed flexible cord	60227 IEC 52	H03VV-F H03VVH2-F																																																					
Ordinary polyvinyl chloride sheathed flexible cord	60227 IEC 53	H05VV-F H05VVH2-F																																																					
<b>Rubber insulated cords</b>																																																							
Braided cord	60245 IEC 51	H03RT-F																																																					
Ordinary tough rubber sheathed flexible cord	60245 IEC 53	H05RR-F																																																					
Ordinary polychloroprene sheathed flexible cord	60245 IEC 57	H05RN-F																																																					
Heavy polychloroprene sheathed flexible cord	60245 IEC 66	H07RN-F																																																					
<b>Cords having high flexibility</b>																																																							
Rubber insulated and sheathed cord	60245 IEC 86	H03RR-H																																																					
Rubber insulated, crosslinked PVC sheathed cord	60245 IEC 87	H03RV4-H																																																					
Crosslinked PVC insulated and sheathed cord	60245 IEC 88	H03V4V4-H																																																					
<b>Cords insulated and sheathed with halogen-free thermoplastic compounds</b>																																																							
Light halogen-free thermoplastic insulated and sheathed flexible cords		H03Z1Z1-F H03Z1Z1H2-F																																																					
Ordinary halogen-free thermoplastic insulated and sheathed flexible cords		H05Z1Z1-F H05Z1Z1H2-F																																																					

Any report having not been signed by authorized approver, or having been altered without authorization, or having not been stamped by the “Dedicated Testing/Inspection Stamp” is deemed to be invalid. Copying or excerpting portion of, or altering the content of the report is not permitted without the written authorization of AGC. The test results presented in the report apply only to the tested sample. Any objections to report issued by AGC should be submitted to AGC within 15days after the issuance of the test report. Further enquiry of validity or verification of the test report should be addressed to AGC by agc01@agccert.com.



5.2		TABLE: Classification of electrical energy sources					P
Supply Voltage	Location (e.g. circuit designation)	Test conditions	Parameters				ES Class
			U (V)	I (mA)	Type <sup>1)</sup>	Additional Info <sup>2)</sup>	
Earphone							
5Vdc	Internal circuit	Normal	5.0	--	DC	--	ES1 (By declared)
		Abnormal	--	--	--	--	
		Single fault – SC/OC	--	--	--	--	
Fully charged battery	Battery pack	Normal	4.20	--	DC	--	ES1
		Abnormal	--	--	--	--	
		Single fault	--	--	--	--	
Charging base							
5Vdc	Internal circuit	Normal	5.0	--	DC	--	ES1 (By declared)
		Abnormal	--	--	--	--	
		Single fault – SC/OC	--	--	--	--	
Fully charged battery	Battery pack	Normal	4.20	--	DC	--	ES1
		Abnormal	--	--	--	--	
		Single fault	--	--	--	--	
Supplementary information:							

5.4.1.8		TABLE: Working voltage measurement				N
Location		RMS voltage (V)	Peak voltage (V)	Frequency (Hz)	Comments	
--		--	--	--	--	
--		--	--	--	--	
Supplementary information:						

5.4.1.10.2		TABLE: Vicat softening temperature of thermoplastics			N
Method..... : .....				ISO 306 / B50	—
Object/ Part No./Material	Manufacturer/trademark		Thickness (mm)	T softening (°C)	
--	--		--	--	
--	--		--	--	
Supplementary information:					

Any report having not been signed by authorized approver, or having been altered without authorization, or having not been stamped by the “Dedicated Testing/Inspection Stamp” is deemed to be invalid. Copying or excerpting portion of, or altering the content of the report is not permitted without the written authorization of AGC. The test results presented in the report apply only to the tested sample. Any objections to report issued by AGC should be submitted to AGC within 15days after the issuance of the test report. Further enquiry of validity or verification of the test report should be addressed to AGC by agc01@agccert.com.

5.4.1.10.3	TABLE: Ball pressure test of thermoplastics				N
Allowed impression diameter (mm)..... :					—
Object/Part No./Material	Manufacturer/trademark	Thickness (mm)	Test temperature (°C)	Impression diameter (mm)	
--	--	--	--	--	
Supplementary information:					

5.4.2, 5.4.3	TABLE: Minimum Clearances/Creepage distance							N
Clearance (cl) and creepage distance (cr) at/of/between:	U <sub>p</sub> (V)	U <sub>rms</sub> (V)	Freq <sup>1)</sup> (Hz)	Required cl (mm)	cl (mm)	E.S. <sup>2)</sup> (V)	Required cr (mm)	cr (mm)
--	--	--	--	--	--	--	--	--
Supplementary information:								

5.4.4.2	TABLE: Minimum distance through insulation				N
Distance through insulation (DTI) at/of	Peak voltage (V)	Insulation	Required DTI (mm)	Measured DTI (mm)	
--	--	--	--	--	
Supplementary information:					

5.4.4.9	TABLE: Solid insulation at frequencies >30 kHz						N
Insulation material	E <sub>P</sub>	Frequency (kHz)	K <sub>R</sub>	Thickness d (mm)	Insulation	V <sub>PW</sub> (Vpk)	
--	--	--	--	--	--	--	
Supplementary information:							

5.4.9	TABLE: Electric strength tests			N
Test voltage applied between:	Voltage shape (Surge, Impulse, AC, DC, etc.)	Test voltage (V)	Breakdown Yes / No	
--	--	--	--	
--	--	--	--	
Supplementary information:				

5.5.2.2	TABLE: Stored discharge on capacitors				N
Location	Supply voltage (V)	Operating and fault condition <sup>1)</sup>	Switch position	Measured voltage (Vpk)	ES Class
--	--	--	--	--	--

Any report having not been signed by authorized approver, or having been altered without authorization, or having not been stamped by the “Dedicated Testing/Inspection Stamp” is deemed to be invalid. Copying or excerpting portion of, or altering the content of the report is not permitted without the written authorization of AGC. The test results presented in the report apply only to the tested sample. Any objections to report issued by AGC should be submitted to AGC within 15days after the issuance of the test report. Further enquiry of validity or verification of the test report should be addressed to AGC by agc01@agccert.com.

Supplementary information:  
 X-capacitors installed for testing:  
 bleeding resistor rating:  
 ICX:  
 1) Normal operating condition (e.g., normal operation, or open fuse), SC= short circuit, OC= open circuit

5.6.6	TABLE: Resistance of protective conductors and terminations				N
Location	Test current (A)	Duration (min)	Voltage drop (V)	Resistance (Ω)	
--	--	--	--	--	

Supplementary information:

5.7.4	TABLE: Unearthed accessible parts					N
Location	Operating and fault conditions	Supply Voltage (V)	Parameters			ES class
			Voltage (V <sub>rms</sub> or V <sub>pk</sub> )	Current (A <sub>rms</sub> or A <sub>pk</sub> )	Freq. (Hz)	
--	--	--	--	--	--	--

Supplementary information:  
 Abbreviation: SC= short circuit; OC= open circuit

5.7.5	TABLE: Earthed accessible conductive part				N
Supply voltage (V).....:					---
Phase(s) .....		<input type="checkbox"/> Single Phase; <input type="checkbox"/> Three Phase: <input type="checkbox"/> Delta <input type="checkbox"/> Wye			
Power Distribution System .....		<input type="checkbox"/> TN <input type="checkbox"/> TT <input type="checkbox"/> IT			
Location	Fault Condition No in IEC 60990 clause 6.2.2	Touch current (mA)	Comment		
--	--	--	--		

Supplementary Information:

5.8	TABLE: Backfeed safeguard in battery backed up supplies					N
Location	Supply voltage (V)	Operating and fault condition	Time (s)	Open-circuit voltage (V)	Touch current (A)	ES Class
--	--	--	--	--	--	--

Supplementary information:  
 Abbreviation: SC= short circuit, OC= open circuit

6.2.2	TABLE: Power source circuit classifications					P
Location	Operating and fault condition	Voltage (V)	Current (A)	Max. Power <sup>1)</sup>	Time (S)	PS class

Any report having not been signed by authorized approver, or having been altered without authorization, or having not been stamped by the "Dedicated Testing/Inspection Stamp" is deemed to be invalid. Copying or excerpting portion of, or altering the content of the report is not permitted without the written authorization of AGC. The test results presented in the report apply only to the tested sample. Any objections to report issued by AGC should be submitted to AGC within 15days after the issuance of the test report. Further enquiry of validity or verification of the test report should be addressed to AGC by agc01@agccert.com.

				(W)		
Type-C port	Normal	--	--	--	--	PS2 by declared
Battery cell (Charging base)	Overload	2.31	7.60	17.56	5	PS2
Battery pack (Charging base)	Overload	3.38	1.78	6.02	3	PS1
Battery cell (Earphone)	Overload	2.24	2.30	5.15	3	PS1
Battery pack (Earphone)	Overload	3.49	0.48	1.68	3	PS1
Supplementary information:						

6.2.3.1	TABLE: Determination of Arcing PIS				N
Location	Open circuit voltage after 3 s (Vpk)	Measured r.m.s current (A)	Calculated value	Arcing PIS? Yes / No	
--	--	--	--	--	
Supplementary information:					

6.2.3.2	TABLE: Determination of resistive PIS			P
Location	Operating and fault condition	Dissipate power (W)		Resistive PIS? Yes / No
--	--	--		Yes (Declared)
Supplementary information: Abbreviation: SC= short circuit; OC= open circuit				

8.5.5	TABLE: High pressure lamp				N
Lamp manufacturer	Lamp type	Explosion method	Longest axis of glass particle (mm)	Particle found beyond 1 m Yes / No	
--	--	--	--	--	
Supplementary information:					

Any report having not been signed by authorized approver, or having been altered without authorization, or having not been stamped by the "Dedicated Testing/Inspection Stamp" is deemed to be invalid. Copying or excerpting portion of, or altering the content of the report is not permitted without the written authorization of AGC. The test results presented in the report apply only to the tested sample. Any objections to report issued by AGC should be submitted to AGC within 15days after the issuance of the test report. Further enquiry of validity or verification of the test report should be addressed to AGC by agc01@agccert.com.

9.6		TABLE: Temperature measurements for wireless power transmitters						N	
Supply voltage (V).....:								—	
Max. transmit power of transmitter (W).....:								—	
Foreign objects	w/o receiver and direct contact		with receiver and direct contact		with receiver and at distance of 2 mm		with receiver and at distance of 5 mm		
	Object (°C)	Ambient (°C)	Object (°C)	Ambient (°C)	Object (°C)	Ambient (°C)	Object (°C)	Ambient (°C)	
--	--	--	--	--	--	--	--	--	
Supplementary information:									

5.4.1.4, 9.3, B.1.5, B.2.6		TABLE: Temperature measurements			P
Supply voltage (V) .....		a) Only charge c) Charge and Discharge d) Only Discharge			—
Ambient temperature during test $T_{amb}$ (°C).....:		40.0	40.0	40.0	—
Maximum measured temperature $T$ of part/at:		$T$ (°C)			Allowed $T_{max}$ (°C)
Test condition No.:		a)	c)	d)	--
<b>Earphone</b>					
Battery surface		47.9	--	46.8	Ref.
Internal wire from battery		47.1	--	46.1	Ref.
PCB near U16		51.3	--	49.4	130
Plastic enclosure inside near PCB		48.2	--	48.0	Ref.
Ambient		45.0	--	45.0	--
For accessible part					
Button		27.1	--	25.7	48
Plastic enclosure outside near PCB		28.3	--	25.9	48
Ambient		25.0	--	25.0	--
<b>Charging base</b>					
Internal wire from battery		45.2	52.3	52.3	Ref.
Battery surface		45.8	52.8	52.5	Ref.
PCB near U1		52.1	57.6	55.9	130
Plastic enclosure inside near PCB		47.0	54.4	52.9	Ref.
Ambient		45.0	45.0	45.0	--
For accessible part					
Plastic enclosure outside near PCB		28.4	28.6	27.5	77
Ambient		25.0	25.0	25.0	--

Any report having not been signed by authorized approver, or having been altered without authorization, or having not been stamped by the "Dedicated Testing/Inspection Stamp" is deemed to be invalid. Copying or excerpting portion of, or altering the content of the report is not permitted without the written authorization of AGC. The test results presented in the report apply only to the tested sample. Any objections to report issued by AGC should be submitted to AGC within 15days after the issuance of the test report. Further enquiry of validity or verification of the test report should be addressed to AGC by agc01@agccert.com.

Supplementary information: \*) Temperature limits for winding include less 10K for thermocouple measurement method.

Temperature T of winding:	t <sub>1</sub> (°C)	R <sub>1</sub> (Ω)	t <sub>2</sub> (°C)	R <sub>2</sub> (Ω)	T (°C)	Allowed T <sub>max</sub> (°C)	Insulation class
--	--	--	--	--	--	--	--
--	--	--	--	--	--	--	--

Supplementary information: Note 1: Tma should be considered as directed by applicable requirement  
Note 2: Tma is not included in assessment of Touch Temperatures (Clause 9)

B.2.5		TABLE: Input test						P
U (V)	Hz	I (A)	I rated (A)	P (W)	P rated (W)	Fuse No	I fuse (A)	Condition/status
5.0	--	0.197	0.185	0.99	--	--	--	Condition a. Battery current for charging base: 140mA Earphone: 28mA
5.0	--	0.196	0.185	0.98	--	--	--	Condition b Battery current for charging base: 183mA
4.20	--	0.093	--	0.39	--	--	--	Condition c Battery current for Earphone: 28mA
4.20	--	0.014	--	0.059	--	--	--	Condition d

Supplementary information:  
Condition a: The charging base and Earphones were equipped with fully discharged battery.  
Condition b: The charging base was equipped with fully discharged battery only.  
Condition c: The charging base was equipped with fully charged battery, and Earphones were equipped with fully discharge battery.  
Condition d: Discharge, Earphones were equipped with fully charge battery.

B.3, B.4		TABLE: Abnormal operating and fault condition tests					P
Ambient temperature T <sub>amb</sub> (°C)..... :		25					—
Power source for EUT: Manufacturer, model/type, outputrating... :		--					—
Component No.	Condition	Supply voltage (V)	Test time	Fuse no.	Fuse current (A)	Observation	
The EUT was supplied by fully charged battery (Earphone)							
Speaker	S-C	4.20	1h45mins	--	--	Unit shutdown at last, no damage and hazards.	
U16, Pin 6-19	S-C	4.20	10mins	--	--	Unit shutdown at last, no damage and hazards.	
The EUT was supplied by fully discharged battery (Earphone)							
U16, Pin 6-7	S-C	5.0	7h	--	--	Unit shutdown at last, no damage and hazards.	
The EUT was supplied by fully charged battery (Charging base)							

Any report having not been signed by authorized approver, or having been altered without authorization, or having not been stamped by the "Dedicated Testing/Inspection Stamp" is deemed to be invalid. Copying or excerpting portion of, or altering the content of the report is not permitted without the written authorization of AGC. The test results presented in the report apply only to the tested sample. Any objections to report issued by AGC should be submitted to AGC within 15days after the issuance of the test report. Further enquiry of validity or verification of the test report should be addressed to AGC by agc01@agccert.com.

U1, Pin 2-8	S-C	4.20	30mins	--	--	Unit shutdown at last, no damage and hazards.
B- and P-	S-C	4.20	30mins	--	--	EUT working normally, no damage and hazards.
The EUT was supplied by fully discharged battery (Charging base)						
B- and P-	S-C	5.0	7h	--	--	EUT working normally, no damage and hazards.
U1, pin 2-3	S-C	5.0	30mins	--	--	Unit shutdown at last, no damage and hazards.
Supplementary information: S-C= short circuit.						

<b>M.3</b>	<b>TABLE: Protection circuits for batteries provided within the equipment</b>						<b>P</b>
Is it possible to install the battery in a reverse polarity position?.....:					Impossible		—
Equipment Specification	Charging						
	Voltage (V)			Current (A)			
	5.0			0.185			
Manufacturer/type	Battery specification						
	Non-rechargeable batteries		Rechargeable batteries				
	Discharging current (A)	Unintentional charging current (A)	Charging		Discharging current (A)	Reverse charging current (A)	
			Voltage (V)	Current (A)			
Earphone							
401010	--	--	--	0.030	0.030	--	
Charging base							
402030	--	--	--	0.185	0.185	--	
Note: The tests of M.3.2 are applicable only when above appropriate data is not available.							
Specified battery temperature (°C).....:				Earphone: Charge: 0 – 45°C Charging base: Charge: 0 –45°C		--	
Component No.	Fault condition	Charge/discharge mode	Test time	Temp. (°C)	Current (A)	Voltage (V)	Observation
--	--	--	--	--	--	--	--
--	--	--	--	--	--	--	--
Supplementary information: see table Annex B.2.5 and B.3, B.4 for detail							

<b>M.4.2</b>	<b>TABLE: Charging safeguards for equipment containing a secondary lithium battery</b>						<b>P</b>
--------------	--	--	--	--	--	--	----------

Any report having not been signed by authorized approver, or having been altered without authorization, or having not been stamped by the “Dedicated Testing/Inspection Stamp” is deemed to be invalid. Copying or excerpting portion of, or altering the content of the report is not permitted without the written authorization of AGC. The test results presented in the report apply only to the tested sample. Any objections to report issued by AGC should be submitted to AGC within 15days after the issuance of the test report. Further enquiry of validity or verification of the test report should be addressed to AGC by agc01@agccert.com.



Maximum specified charging voltage (V)..... :	4.20 (Earphone) 4.20 (Charging base)	—
Maximum specified charging current (A) .....	0.030 (Earphone) 0.185 (Charging base)	—
Highest specified charging temperature (°C) .....	45 (Earphone) 45 (Charging base)	
Lowest specified charging temperature (°C) .....	0 (Earphone) 0 (Charging base)	

Battery manufacturer/type	Operating and fault condition	Measurement			Observation
		Charging voltage (V)	Charging current (A)	Temp. (°C)	

**Earphone**

401010	Normal	4.17	0.028	Battery surface: 26.5 Ambient: 25.0	The battery charging voltage does not exceed 4.2V and the battery charging current does not exceed 30mA.
401010	Single fault: S-C	4.19	0	Battery surface: 25.5 Ambient: 25.0	The battery charging voltage does not exceed 4.2V and the battery charging current does not exceed 30mA.
401010	Normal	4.16	0.016	0	The battery charging current does not exceed 30mA.
401010	Normal	4.16	0	45	The battery stopped charging.

**Charging base**

402030	Normal	4.17	0.183	Battery surface: 28.7 Ambient: 25.0	The battery charging voltage does not exceed 4.28V and the battery charging current does not exceed 185mA.
402030	Single fault: S-C	4.18	0	Battery surface: 26.0 Ambient: 25.0	The battery charging voltage does not exceed 4.28V and the battery charging current does not exceed 185mA.
402030	Normal	4.17	0.089	0	The battery charging current does not exceed 185mA.
402030	Normal	4.16	0	45	The battery stopped charging.

**Supplementary information:**

Any report having not been signed by authorized approver, or having been altered without authorization, or having not been stamped by the "Dedicated Testing/Inspection Stamp" is deemed to be invalid. Copying or excerpting portion of, or altering the content of the report is not permitted without the written authorization of AGC. The test results presented in the report apply only to the tested sample. Any objections to report issued by AGC should be submitted to AGC within 15days after the issuance of the test report. Further enquiry of validity or verification of the test report should be addressed to AGC by agc01@agccert.com.

Q.1	TABLE: Circuits intended for interconnection with building wiring (LPS)						N
Output Circuit	Condition	U <sub>oc</sub> (V)	Time (s)	I <sub>sc</sub> (A)		S (VA)	
				Meas.	Limit	Meas.	Limit
--	--	--	--	--	--	--	--
Supplementary Information:							

T.2, T.3, T.4, T.5	TABLE: Steady force test						P
Part/Location	Material	Thickness (mm)	Probe	Force (N)	Test Duration (s)	Observation	
Earphone							
Top enclosure	Plastic	See table 4.1.2	30mm probe	100	5	No damaged	
Side enclosure	Plastic	See table 4.1.2	30mm probe	100	5	No damaged	
Bottom enclosure	Plastic	See table 4.1.2	30mm probe	100	5	No damaged	
Charging base(MO6128)							
Top enclosure	Plastic	See table 4.1.2	30mm probe	100	5	No damaged	
Side enclosure	Plastic	See table 4.1.2	30mm probe	100	5	No damaged	
Bottom enclosure	Plastic	See table 4.1.2	30mm probe	100	5	No damaged	
Charging base(MO6780)							
Top enclosure	Plastic	See table 4.1.2	30mm probe	100	5	No damaged	
Side enclosure	Plastic	See table 4.1.2	30mm probe	100	5	No damaged	
Bottom enclosure	Plastic	See table 4.1.2	30mm probe	100	5	No damaged	
Supplementary information:							

T.6, T.9	TABLE: Impact test				N
Location/part	Material	Thickness (mm)	Height (mm)	Observation	
--	--	--	--	--	
Supplementary information:					

T.7	TABLE: Drop test				P
Location/part	Material	Thickness (mm)	Height (mm)	Observation	
Earphone					
Top enclosure	Plastic	See table 4.1.2	1000	No damaged	
Side enclosure	Plastic	See table 4.1.2	1000	No damaged	

Any report having not been signed by authorized approver, or having been altered without authorization, or having not been stamped by the "Dedicated Testing/Inspection Stamp" is deemed to be invalid. Copying or excerpting portion of, or altering the content of the report is not permitted without the written authorization of AGC. The test results presented in the report apply only to the tested sample. Any objections to report issued by AGC should be submitted to AGC within 15days after the issuance of the test report. Further enquiry of validity or verification of the test report should be addressed to AGC by agc01@agccert.com.

Bottom enclosure	Plastic	See table 4.1.2	1000	No damaged
Charging base(MO6128)				
Top enclosure	Plastic	See table 4.1.2	1000	No damaged
Side enclosure	Plastic	See table 4.1.2	1000	No damaged
Bottom enclosure	Plastic	See table 4.1.2	1000	No damaged
Charging base(MO6780)				
Top enclosure	Plastic	See table 4.1.2	1000	No damaged
Side enclosure	Plastic	See table 4.1.2	1000	No damaged
Bottom enclosure	Plastic	See table 4.1.2	1000	No damaged
Supplementary information:				

T.8	TABLE: Stress relief test					P
Location/Part	Material	Thickness (mm)	Oven Temperature (°C)	Duration (h)	Observation	
Earphone						
Completed sample	Plastic enclosure (for all sources)	See table 4.1.2	70	7	No damaged, no hazards.	
Charging base(MO6128)						
Completed sample	Plastic enclosure (for all sources)	See table 4.1.2	70	7	No damaged, no hazards.	
Charging base(MO6780)						
Completed sample	Plastic enclosure (for all sources)	See table 4.1.2	70	7	No damaged, no hazards.	
Supplementary information:						

X	TABLE: Alternative method for determining minimum clearances distances			N
Clearance distanced between:	Peak of working voltage (V)	Required cl (mm)	Measured cl (mm)	
--	--	--	--	
Supplementary information:				

Any report having not been signed by authorized approver, or having been altered without authorization, or having not been stamped by the "Dedicated Testing/Inspection Stamp" is deemed to be invalid. Copying or excerpting portion of, or altering the content of the report is not permitted without the written authorization of AGC. The test results presented in the report apply only to the tested sample. Any objections to report issued by AGC should be submitted to AGC within 15days after the issuance of the test report. Further enquiry of validity or verification of the test report should be addressed to AGC by agc01@agccert.com.

4.1.2 TABLE: List of critical components					P
Object / part No.	Manufacturer/ trademark	Type / model	Technical data	Standard	Mark(s) of conformity
Earphone					
Battery	SHENZHEN BIYATE ENERGY CO., LTD	401010	3.7V, 30mAh Max charging current: 30mA Max discharging current: 30mA	IEC 62133-2:2017	IEC 62133 Report
Plastic enclosure	CHI MEI CORPORATION	PC-540 G(@@)(a)	Min.0.75mm, HB, 60°C	UL94	UL E56070
Speaker	Interchangeable	Interchangeable	32Ω 2mW	EN IEC 62368-1	Tested with appliance
PCB	Interchangeable	Interchangeable	V-0, 130°C	UL94, UL796	UL
Internal wire	Interchangeable	Interchangeable	Min. 28AWG, min. 80°C, min. 30V, VW-1	UL 758	UL
Charging base					
Battery	SHENZHEN BIYATE ENERGY CO., LTD	402030	3.7V, 185mAh, Max. charging current: 185mA; Max. discharge current: 185mA	IEC 62133-2:2017	IEC 62133 Report No TCT230223B1 35
Plastic enclosure (MO6128)	CHI MEI CORPORATION	PC-540 G(@@)(a)	Min.1.5mm, V-0, 80°C	UL94	UL E56070
Plastic enclosure (MO6780)	CHI MEI CORPORATION	EG-84(##)	Min.1.5mm, V-0, 80°C	UL94	UL E56070
PCB	Interchangeable	Interchangeable	V-0, 130°C	UL94, UL796	UL
Internal wire	Interchangeable	Interchangeable	Min. 28AWG, min. 80°C, min. 30V, VW-1	UL 758	UL
Supplementary information:--					

Any report having not been signed by authorized approver, or having been altered without authorization, or having not been stamped by the "Dedicated Testing/Inspection Stamp" is deemed to be invalid. Copying or excerpting portion of, or altering the content of the report is not permitted without the written authorization of AGC. The test results presented in the report apply only to the tested sample. Any objections to report issued by AGC should be submitted to AGC within 15days after the issuance of the test report. Further enquiry of validity or verification of the test report should be addressed to AGC by agc01@agccert.com.



**Attachment A**  
**Photos of product**



Fig.1 – over view (MO6128)

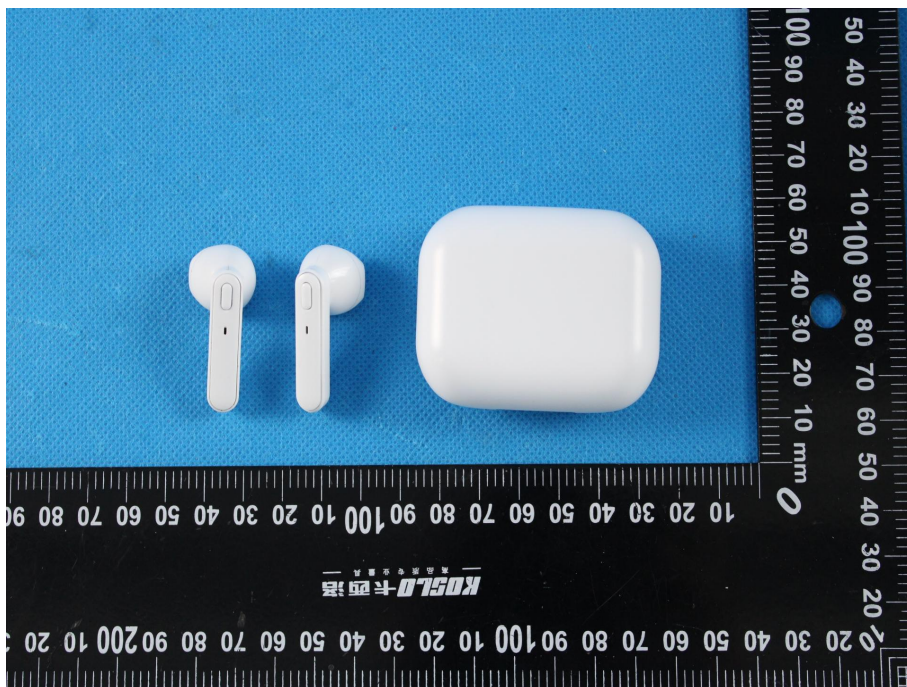

Fig.2 – over view (MO6780)

Any report having not been signed by authorized approver, or having been altered without authorization, or having not been stamped by the “Dedicated Testing/Inspection Stamp” is deemed to be invalid. Copying or excerpting portion of, or altering the content of the report is not permitted without the written authorization of AGC. The test results presented in the report apply only to the tested sample. Any objections to report issued by AGC should be submitted to AGC within 15days after the issuance of the test report. Further enquiry of validity or verification of the test report should be addressed to AGC by agc01@agccert.com.



Fig.3 – over view (MO6780)



Fig.4 – over view (charging base)

Any report having not been signed by authorized approver, or having been altered without authorization, or having not been stamped by the “Dedicated Testing/Inspection Stamp” is deemed to be invalid. Copying or excerpting portion of, or altering the content of the report is not permitted without the written authorization of AGC. The test results presented in the report apply only to the tested sample. Any objections to report issued by AGC should be submitted to AGC within 15days after the issuance of the test report. Further enquiry of validity or verification of the test report should be addressed to AGC by agc01@agccert.com.



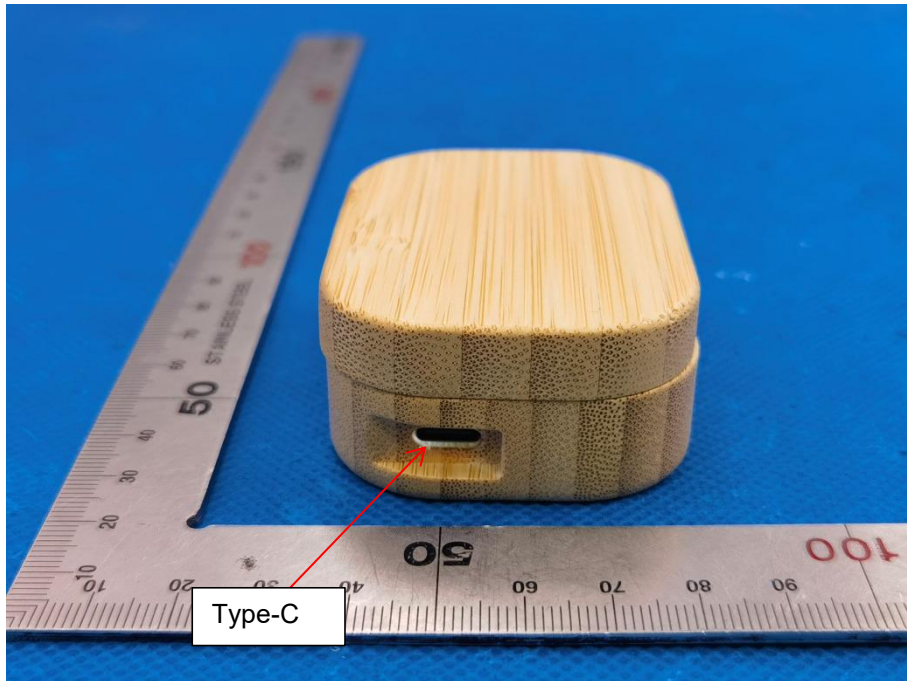

Fig.5 – over view (charging base)

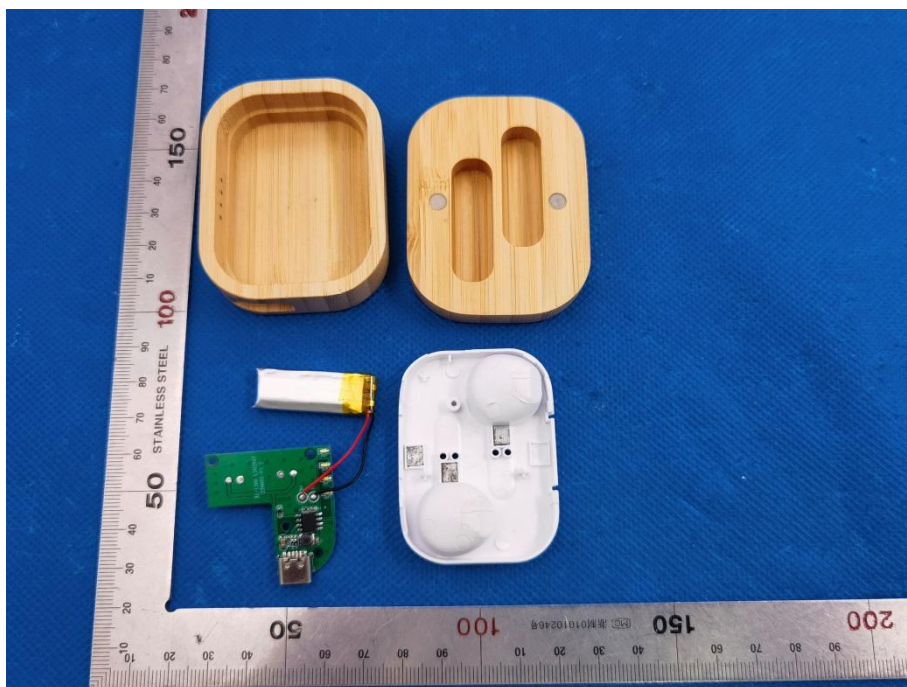

Fig.6 – open view (charging base)

Any report having not been signed by authorized approver, or having been altered without authorization, or having not been stamped by the “Dedicated Testing/Inspection Stamp” is deemed to be invalid. Copying or excerpting portion of, or altering the content of the report is not permitted without the written authorization of AGC. The test results presented in the report apply only to the tested sample. Any objections to report issued by AGC should be submitted to AGC within 15days after the issuance of the test report. Further enquiry of validity or verification of the test report should be addressed to AGC by agc01@agccert.com.



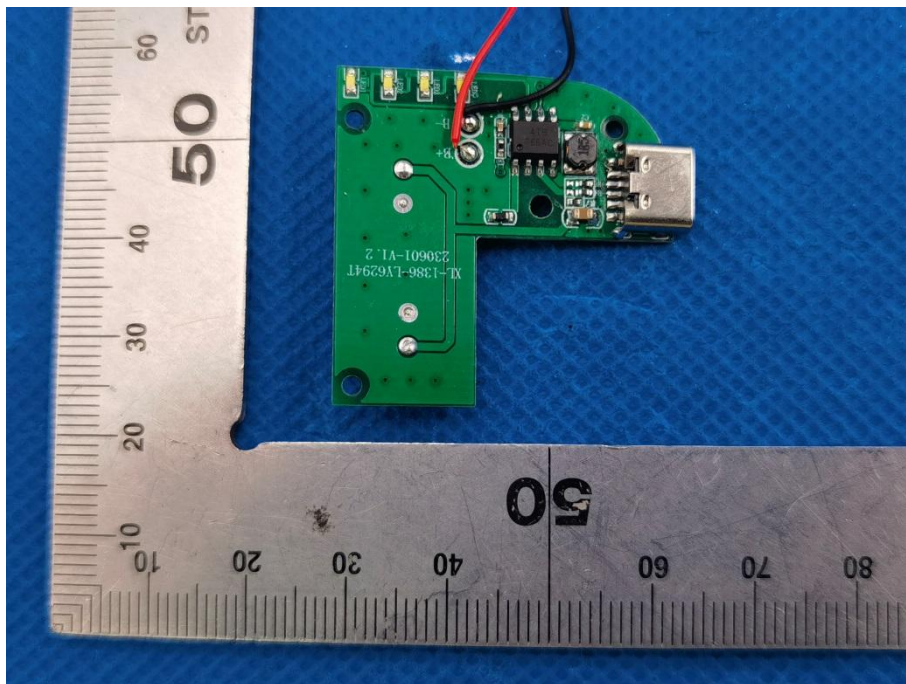

Fig.7 – PCB view (charging base)

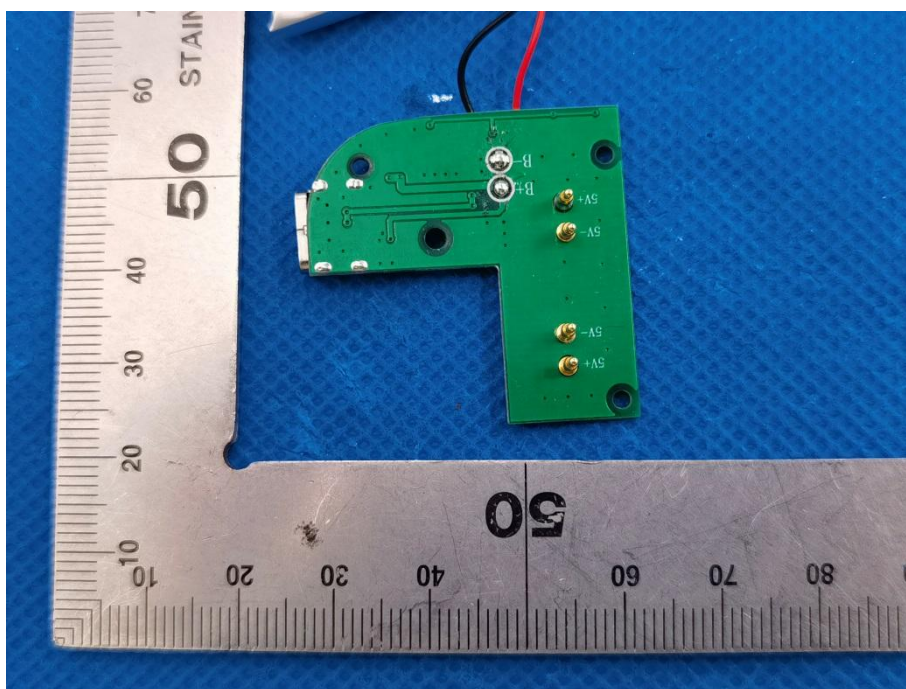

Fig.8 – PCB view (charging base)

Any report having not been signed by authorized approver, or having been altered without authorization, or having not been stamped by the “Dedicated Testing/Inspection Stamp” is deemed to be invalid. Copying or excerpting portion of, or altering the content of the report is not permitted without the written authorization of AGC. The test results presented in the report apply only to the tested sample. Any objections to report issued by AGC should be submitted to AGC within 15days after the issuance of the test report. Further enquiry of validity or verification of the test report should be addressed to AGC by agc01@agccert.com.

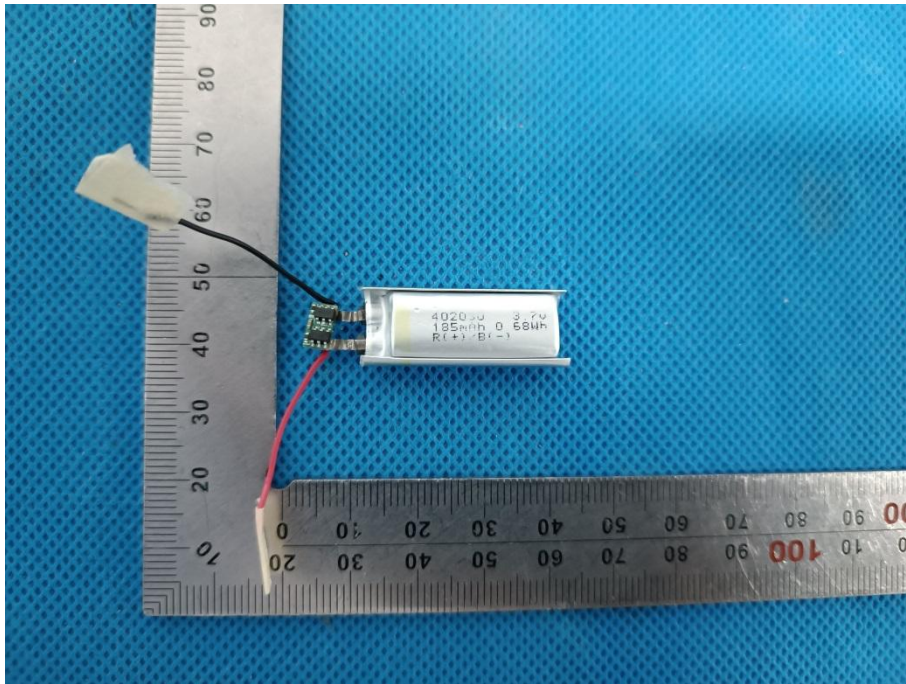

Fig.9 – battery view (charging base)

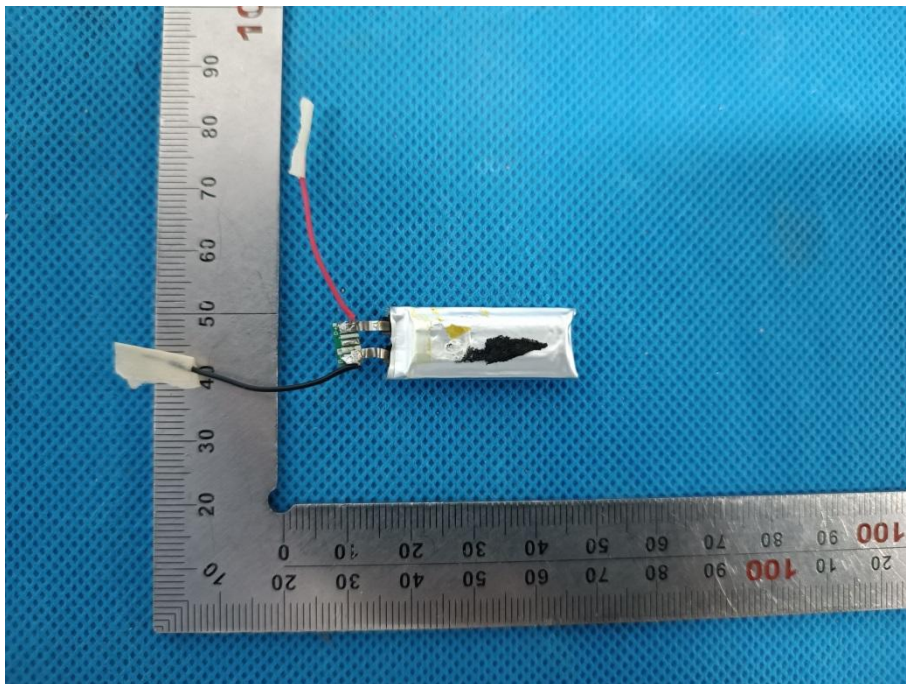

Fig.10 – battery view (charging base)

Any report having not been signed by authorized approver, or having been altered without authorization, or having not been stamped by the “Dedicated Testing/Inspection Stamp” is deemed to be invalid. Copying or excerpting portion of, or altering the content of the report is not permitted without the written authorization of AGC. The test results presented in the report apply only to the tested sample. Any objections to report issued by AGC should be submitted to AGC within 15days after the issuance of the test report. Further enquiry of validity or verification of the test report should be addressed to AGC by agc01@agccert.com.



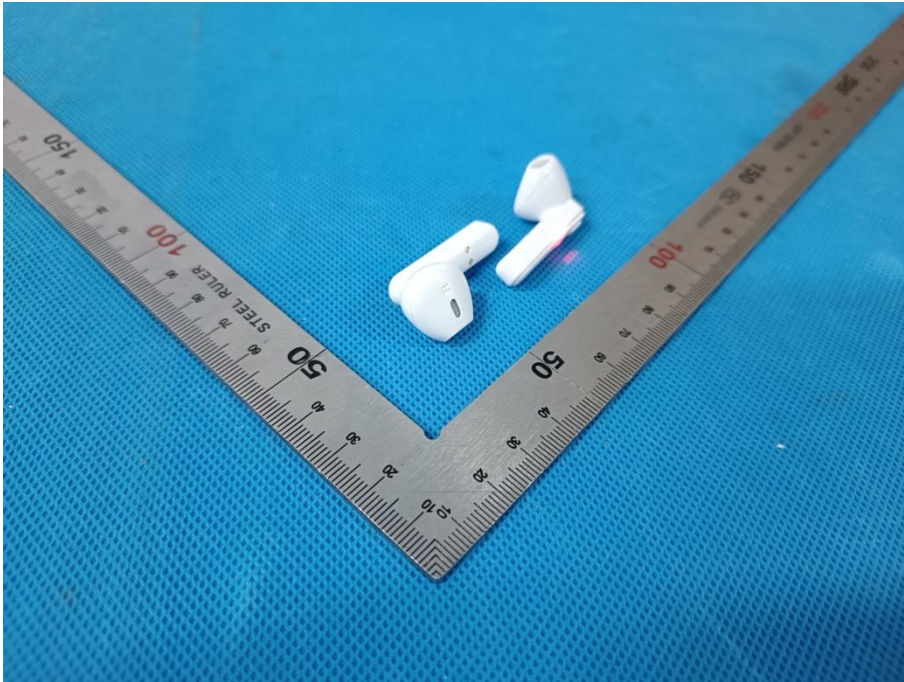

Fig.11 – over view (Earphone)



Fig.12 – over view (Earphone)

Any report having not been signed by authorized approver, or having been altered without authorization, or having not been stamped by the “Dedicated Testing/Inspection Stamp” is deemed to be invalid. Copying or excerpting portion of, or altering the content of the report is not permitted without the written authorization of AGC. The test results presented in the report apply only to the tested sample. Any objections to report issued by AGC should be submitted to AGC within 15days after the issuance of the test report. Further enquiry of validity or verification of the test report should be addressed to AGC by [agc01@agccert.com](mailto:agc01@agccert.com).



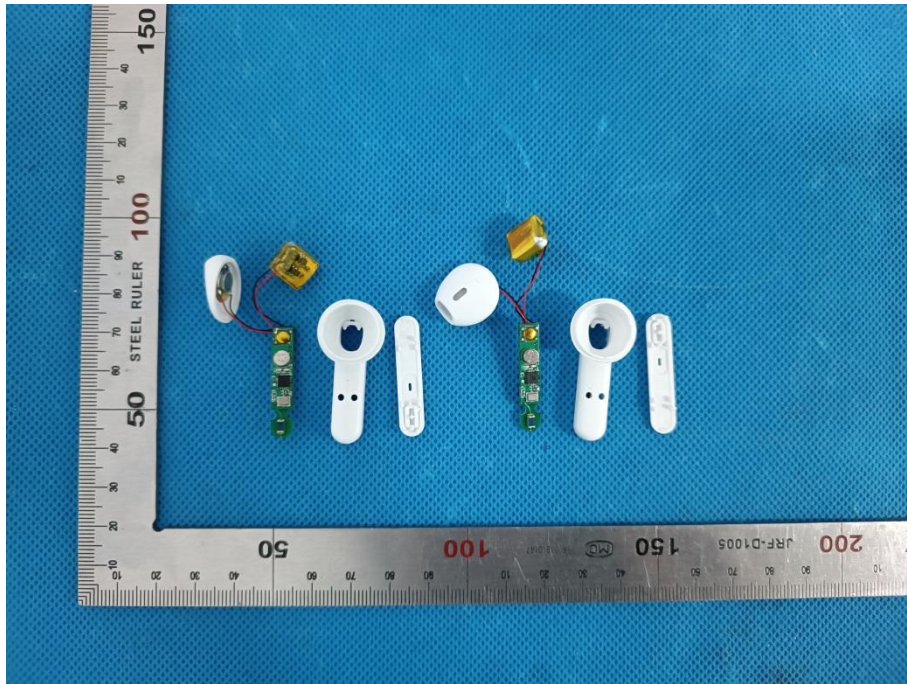

Fig.13 – open view (Earphone)

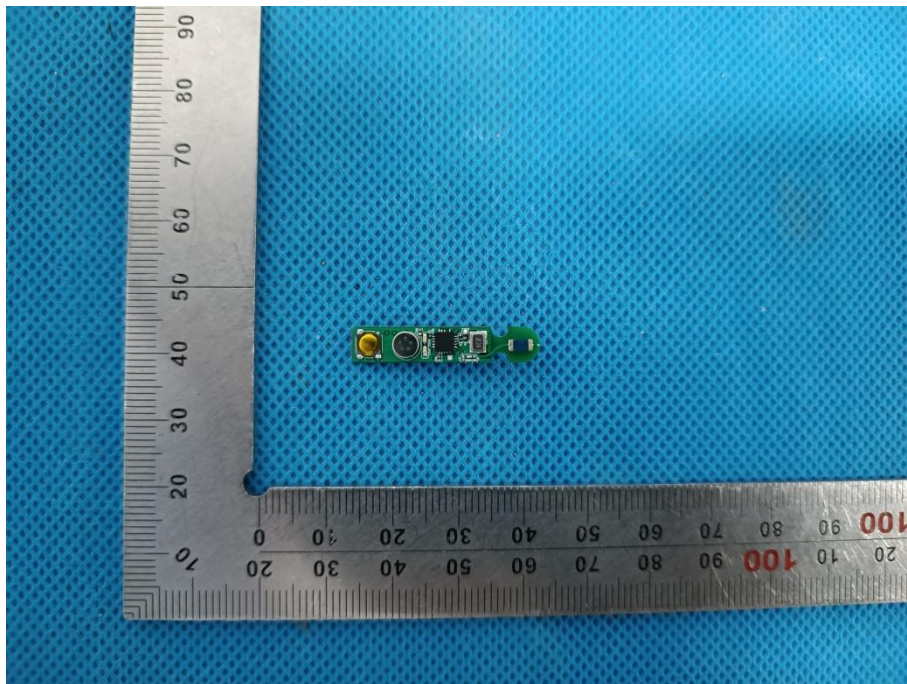

Fig.14 – PCB view (Earphone)

Any report having not been signed by authorized approver, or having been altered without authorization, or having not been stamped by the “Dedicated Testing/Inspection Stamp” is deemed to be invalid. Copying or excerpting portion of, or altering the content of the report is not permitted without the written authorization of AGC. The test results presented in the report apply only to the tested sample. Any objections to report issued by AGC should be submitted to AGC within 15days after the issuance of the test report. Further enquiry of validity or verification of the test report should be addressed to AGC by agc01@agccert.com.



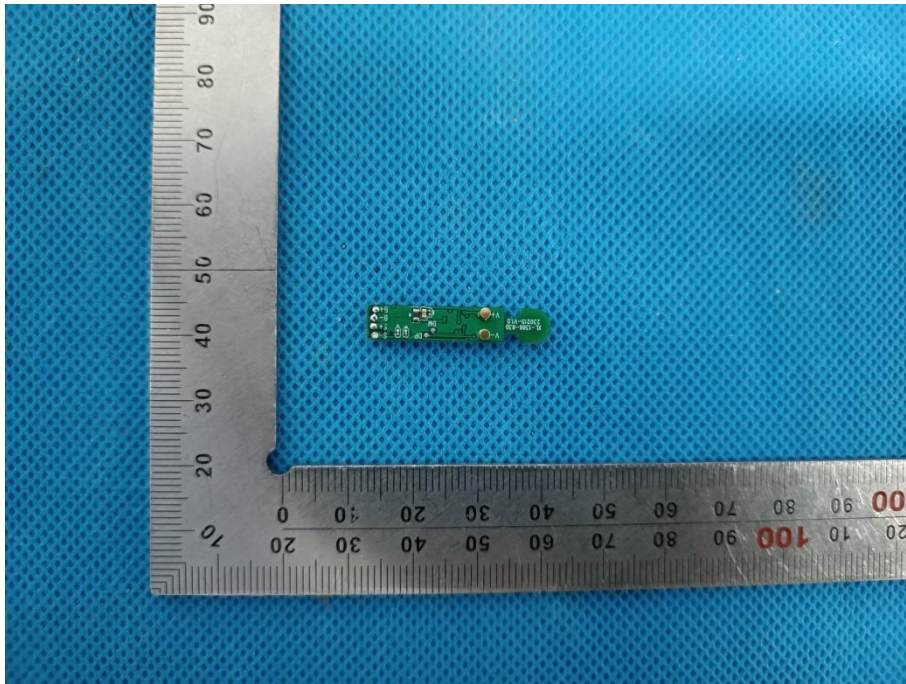

Fig.15 – PCB view (Earphone)

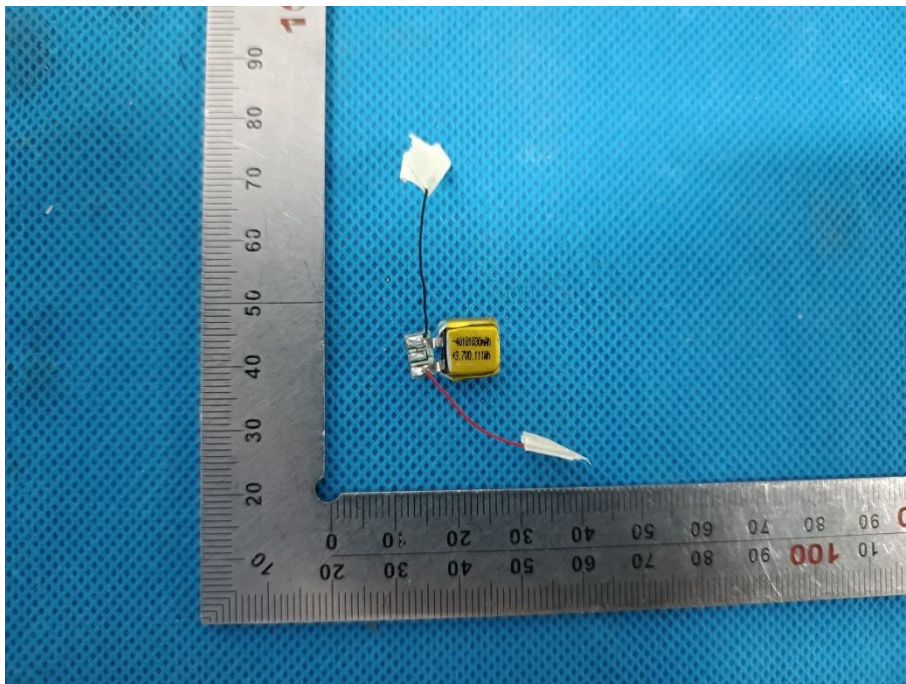

Fig.16 – battery view (Earphone)

Any report having not been signed by authorized approver, or having been altered without authorization, or having not been stamped by the “Dedicated Testing/Inspection Stamp” is deemed to be invalid. Copying or excerpting portion of, or altering the content of the report is not permitted without the written authorization of AGC. The test results presented in the report apply only to the tested sample. Any objections to report issued by AGC should be submitted to AGC within 15days after the issuance of the test report. Further enquiry of validity or verification of the test report should be addressed to AGC by agc01@agccert.com.

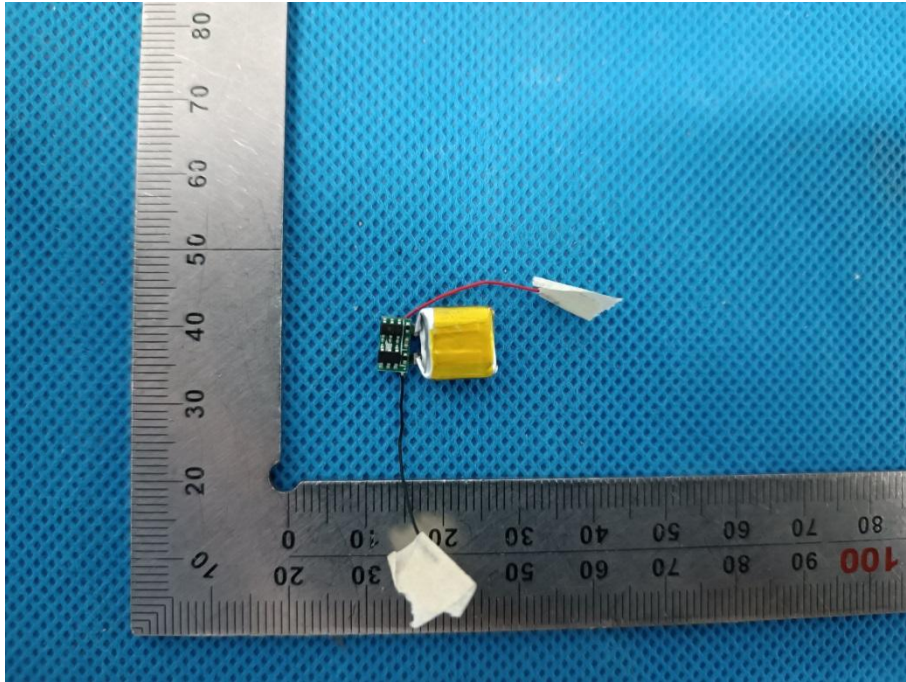

Fig.17 – battery view (Earphone)

**-----END OF REPORT-----**

Any report having not been signed by authorized approver, or having been altered without authorization, or having not been stamped by the “Dedicated Testing/Inspection Stamp” is deemed to be invalid. Copying or excerpting portion of, or altering the content of the report is not permitted without the written authorization of AGC. The test results presented in the report apply only to the tested sample. Any objections to report issued by AGC should be submitted to AGC within 15days after the issuance of the test report. Further enquiry of validity or verification of the test report should be addressed to AGC by [agc01@agccert.com](mailto:agc01@agccert.com).

Attestation of Global Compliance(Shenzhen)Co., Ltd  
Attestation of Global Compliance(Shenzhen)Std & Tech Co., Ltd  
Tel: +86-755 2523 4088 E-mail: [agc@agccert.com](mailto:agc@agccert.com) Web: <http://www.agccert.com/>





## Conditions of Issuance of Test Reports

1. All samples and goods are accepted by the Attestation of Global Compliance (Shenzhen) Co., Ltd (the “Company”) solely for testing and reporting in accordance with the following terms and conditions. The company provides its services on the basis that such terms and conditions constitute express agreement between the company and any person, firm or company requesting its services (the “Clients”).
2. Any report issued by Company as a result of this application for testing services (the “Report”) shall be issued in confidence to the Clients and the Report will be strictly treated as such by the Company. It may not be reproduced either in its entirety or in part and it may not be used for advertising or other unauthorized purposes without the written consent of the Company. The Clients to whom the Report is issued may, however, show or send it, or a certified copy thereof prepared by the Company to its customer, supplier or other persons directly concerned. The Company will not, without the consent of the Clients, enter into any discussion or correspondence with any third party concerning the contents of the Report, unless required by the relevant governmental authorities, laws or court orders.
3. The Company shall not be called or be liable to be called to give evidence or testimony on the Report in a court of law without its prior written consent, unless required by the relevant governmental authorities, laws or court orders.
4. In the event of the improper use of the report as determined by the Company, the Company reserves the right to withdraw it, and to adopt any other additional remedies which may be appropriate.
5. Samples submitted for testing are accepted on the understanding that the Report issued cannot form the basis of, or be the instrument for, any legal action against the Company.
6. The Company will not be liable for or accept responsibility for any loss or damage however arising from the use of information contained in any of its Reports or in any communication whatsoever about its said tests or investigations.
7. Clients wishing to use the Report in court proceedings or arbitration shall inform the Company to that effect prior to submitting the sample for testing.
8. The Company is not responsible for recalling the electronic version of the original report when any revision is made to them. The Client assumes the responsibility to providing the revised version to any interested party who uses them.
9. Subject to the variable length of retention time for test data and report stored hereinto as otherwise specifically required by individual accreditation authorities, the Company will only keep the supporting test data and information of the test report for a period of six years. The data and information will be disposed of after the aforementioned retention period has elapsed. Under no circumstances shall we provide any data and information which has been disposed of after retention period. Under no circumstances shall we be liable for damage of any kind, including (but not limited to) compensatory damages, lost profits, lost data, or any form of special, incidental, indirect, consequential or punitive damages of any kind, whether based on breach of contract of warranty, tort (including negligence), product liability or otherwise, even if we are informed in advance of the possibility of such damages.

Any report having not been signed by authorized approver, or having been altered without authorization, or having not been stamped by the “Dedicated Testing/Inspection Stamp” is deemed to be invalid. Copying or excerpting portion of, or altering the content of the report is not permitted without the written authorization of AGC. The test results presented in the report apply only to the tested sample. Any objections to report issued by AGC should be submitted to AGC within 15days after the issuance of the test report. Further enquiry of validity or verification of the test report should be addressed to AGC by [agc01@agccert.com](mailto:agc01@agccert.com).