RF Test Report

Report No.: AGC05443230405EE04

PRODUCT DESIGNATION : TWS earbuds with charging base

BRAND NAME : N/A

MODEL NAME : M06128, M06780

APPLICANT : MID OCEAN BRANDS B.V

DATE OF ISSUE : Jul. 03, 2023

STANDARD(S) : ETSI EN 300 328 V2.2.2 (2019-07)

REPORT VERSION : V1.0

Attestation of Global Compliance (Shenzhen) Co., Ltd



Any report having not been signed by authorized approver, or having been altered without authorization, or having not been stamped by the "Dedicated Testing/Inspection Stamp" is deemed to be invalid. Copying or excerpting portion of, or altering the content of the report is not permitted without the written authorization of AGC. The test results presented in the report apply only to the tested sample. Any objections to report issued by AGC should be submitted to AGC within 15days after the issuance of the test report. Further enquiry of validity or verification of the test report should be addressed to AGC by agc01@agccert.com.

Attestation of Global Compliance(Shenzhen)Co., Ltd
Attestation of Global Compliance(Shenzhen)Std & Tech Co., Ltd
Tel: +86-755 2523 4088 E-mail: agc@agccert.com Web: <http://www.agccert.com/>



REPORT REVISE RECORD

Report Version	Revise Time	Issued Date	Valid Version	Notes
V1.0	/	Jul. 03, 2023	Valid	Initial Release

Any report having not been signed by authorized approver, or having been altered without authorization, or having not been stamped by the “Dedicated Testing/Inspection Stamp” is deemed to be invalid. Copying or excerpting portion of, or altering the content of the report is not permitted without the written authorization of AGC. The test results presented in the report apply only to the tested sample. Any objections to report issued by AGC should be submitted to AGC within 15days after the issuance of the test report. Further enquiry of validity or verification of the test report should be addressed to AGC by agc01@agccert.com.

TABLE OF CONTENTS

1. VERIFICATION OF CONFORMITY 4

2. GENERAL INFORMATION 5

 2.1. EUT DESCRIPTION 5

 2.2. SUPPORT EQUIPMENT 6

 2.3. DESCRIPTION OF TEST MODES 6

 2.4. OBJECTIVE 7

 2.5. TEST ITEMS AND THE RESULTS 7

 2.6. ENVIRONMENTAL CONDITIONS 7

3. MEASUREMENT UNCERTAINTY 8

4. IDENTIFICATION OF THE RESPONSIBLE TESTING LOCATION 9

5. ETSI EN 300 328 REQUIREMENTS 10

 5.1. RF OUTPUT POWER 10

 5.2. ACCUMULATED TRANSMIT TIME, FREQUENCY OCCUPIATION AND HOPPING SEQUENCE 13

 5.3. HOPPING FREQUENCY SEPARATION 20

 5.4. OCCUPIED CHANNEL BANDWIDTH 22

 5.5. TRANSMITTER UNWANTED EMISSIONS IN THE OUT OF BAND DOMAIN 26

 5.6. TRANSMITTER SPURIOUS EMISSIONS 29

 5.7. RECEIVER SPURIOUS EMISSIONS 38

 5.8. RECEIVER BLOCKING 44

APPENDIX A: PHOTOGRAPHS OF THE TEST SETUP 49

APPENDIX B: PHOTOGRAPHS OF EUT 50

Any report having not been signed by authorized approver, or having been altered without authorization, or having not been stamped by the “Dedicated Testing/Inspection Stamp” is deemed to be invalid. Copying or excerpting portion of, or altering the content of the report is not permitted without the written authorization of AGC. The test results presented in the report apply only to the tested sample. Any objections to report issued by AGC should be submitted to AGC within 15days after the issuance of the test report. Further enquiry of validity or verification of the test report should be addressed to AGC by agc01@agccert.com.

1. VERIFICATION OF CONFORMITY

Applicant	MID OCEAN BRANDS B.V
Address	7/F, Kings Tower, 111 King Lam Street, Cheung Sha Wan, Kowloon, Hong Kong.
Manufacturer	MID OCEAN BRANDS B.V
Address	7/F, Kings Tower, 111 King Lam Street, Cheung Sha Wan, Kowloon, Hong Kong.
Factory	MID OCEAN BRANDS B.V
Address	7/F, Kings Tower, 111 King Lam Street, Cheung Sha Wan, Kowloon, Hong Kong.
Product Designation	TWS earbuds with charging base
Brand Name	N/A
Test Model	MO6128
Series Model	MO6780
Declaration Difference	All the same except for the model name and shell.
Date of receipt of test item	Jun. 19, 2023
Date of test	Jun. 19, 2023 to Jul. 03, 2023
Deviation	None
Condition of Test Sample	Normal
Test Result	Pass
Report Template	AGCRT-EC-BR/RF

We (AGC), Attestation of Global Compliance (Shenzhen) Co., Ltd. for compliance with the requirements set forth in the European Standard ETSI EN 300 328 V2.2.2. The results of test in this report apply to the product/system which was tested only. Other similar equipment will not necessarily produce the same results due to production tolerance and measurement uncertainties.

Prepared By



Cici Ci
(Project Engineer) Jul. 03, 2023

Reviewed By



Calvin Liu
(Reviewer) Jul. 03, 2023

Approved By



Max Zhang
(Authorized Officer) Jul. 03, 2023

Any report having not been signed by authorized approver, or having been altered without authorization, or having not been stamped by the "Dedicated Testing/Inspection Stamp" is deemed to be invalid. Copying or excerpting portion of, or altering the content of the report is not permitted without the written authorization of AGC. The test results presented in the report apply only to the tested sample. Any objections to report issued by AGC should be submitted to AGC within 15days after the issuance of the test report. Further enquiry of validity or verification of the test report should be addressed to AGC by agc01@agccert.com.

2. GENERAL INFORMATION

2.1. EUT DESCRIPTION

Operating Frequency Range(s)	2402MHz~2480MHz
The type of the equipment	FHSS adaptive equipment with only one antenna
The number of Hopping Frequencies	79
Modulation	BR: <input checked="" type="checkbox"/> GFSK EDR: <input checked="" type="checkbox"/> π /4-DQPSK, <input checked="" type="checkbox"/> 8DPSK
Bluetooth Version	V5.0
Hardware Version	V1
Software Version	V1
The maximum RF Output Power	-0.15dBm
Antenna designation	Ceramic Antenna
Antenna Gain	-0.58dBi
Power Supply (Headset)	DC 3.7V by battery
Power Supply (Charging dock)	DC 3.7V by battery or DC 5V by adapter
The extreme operating conditions	Lowest temperature range (LT): -10°C Normal temperature range (NT): 25°C Highest temperature range (HT): 45°C
Geo-location capability	<input type="checkbox"/> Yes <input checked="" type="checkbox"/> No

Note:

1. The above information was declared by the manufacturer.
2. The equipment submitted representative production models.
3. The EUT cannot operated unmodulated.
4. The EUT provides Bluetooth wireless interface operating at 2.4G ISM band (2402MHz-2480MHz).
5. Only the Bluetooth was tested according the standard requirement.
6. The EUT is a stand-alone and portable equipment according to ETSI EN 300 328 V2.2.2.
7. For more details, please refer to the User's manual of the EUT.
8. The EUT doesn't support BLE.
9. The EUT comprises left and right channel headsets, both are the same, the left headset had been tested and recorded in this report as the worst case.

Any report having not been signed by authorized approver, or having been altered without authorization, or having not been stamped by the "Dedicated Testing/Inspection Stamp" is deemed to be invalid. Copying or excerpting portion of, or altering the content of the report is not permitted without the written authorization of AGC. The test results presented in the report apply only to the tested sample. Any objections to report issued by AGC should be submitted to AGC within 15days after the issuance of the test report. Further enquiry of validity or verification of the test report should be addressed to AGC by agc01@agccert.com.

2.2. SUPPORT EQUIPMENT

Item	Equipment	Mfr/Brand	Model/Type No.	Remark
--	--	--	--	--

2.3. DESCRIPTION OF TEST MODES

Test Mode	Description
BR_TX_2402_1Mbps	Bluetooth BR Transmitting mode (Channel: 2402, Rate: 1Mbps)
BR_TX_2480_1Mbps	Bluetooth BR Transmitting mode (Channel: 2480, Rate: 1Mbps)
EDR_TX_2402_2Mbps	Bluetooth EDR Transmitting mode (Channel: 2402, Rate: 2Mbps)
EDR_TX_2480_2Mbps	Bluetooth EDR Transmitting mode (Channel: 2480, Rate: 2Mbps)
EDR_TX_2402_3Mbps	Bluetooth EDR Transmitting mode (Channel: 2402, Rate: 3Mbps)
EDR_TX_2480_3Mbps	Bluetooth EDR Transmitting mode (Channel: 2480, Rate: 3Mbps)
BR_HOP_NA_1Mbps	Bluetooth BR Hopping mode (Rate: 1Mbps)
EDR_HOP_NA_2Mbps	Bluetooth EDR Hopping mode (Rate: 2Mbps)
EDR_HOP_NA_3Mbps	Bluetooth EDR Hopping mode (Rate: 3Mbps)
BR_RX_2402_1Mbps	Bluetooth BR Receiving mode (Channel: 2402, Rate: 1Mbps)
BR_RX_2480_1Mbps	Bluetooth BR Receiving mode (Channel: 2480, Rate: 1Mbps)
EDR_RX_2402_2Mbps	Bluetooth EDR Receiving mode (Channel: 2402, Rate: 2Mbps)
EDR_RX_2480_2Mbps	Bluetooth EDR Receiving mode (Channel: 2480, Rate: 2Mbps)
EDR_RX_2402_3Mbps	Bluetooth EDR Receiving mode (Channel: 2402, Rate: 3Mbps)
EDR_RX_2480_3Mbps	Bluetooth EDR Receiving mode (Channel: 2480, Rate: 3Mbps)

Note:

- All modes have been tested and the worst mode test data recording in the test report, if no any other data.

2.4. OBJECTIVE

Perform Radio Spectrum tests for CE Marking according to the provisions of article 3.2 of the Radio Equipment Directive (2014/53/EU) for the BT function of the EUT.

2.5. TEST ITEMS AND THE RESULTS

The EUT has been tested according to ETSI EN 300 328 V2.2.2(2019-07).

ETSI EN 300 328 V2.2.2 (2019-07)	Wideband transmission systems; Data transmission equipment operating in the 2,4 GHz band; Harmonised Standard for access to radio spectrum
---	--

Test items and the results are as bellow:

No.	Basic Standard	Test Type	Result
1	ETSI EN 300 328 4.3.1.2	RF Output Power	Pass
2	ETSI EN 300 328 4.3.1.3	Duty Cycle, Tx-sequence, Tx-gap	N/A
3	ETSI EN 300 328 4.3.1.4	Accumulated transmit time, Frequency Occupation and hopping sequence	Pass
4	ETSI EN 300 328 4.3.1.5	Hopping Frequency Separation	Pass
5	ETSI EN 300 328 4.3.1.6	Medium Utilisation (MU) factor	N/A
6	ETSI EN 300 328 4.3.1.7	Adaptivity (Adaptive Frequency Hopping)	N/A
7	ETSI EN 300 328 4.3.1.8	Occupied Channel Bandwidth	Pass
8	ETSI EN 300 328 4.3.1.9	Transmitter unwanted emission in the out of band domain	Pass
9	ETSI EN 300 328 4.3.1.10	Transmitter unwanted emission in the spurious domain	Pass
10	ETSI EN 300 328 4.3.1.11	Receiver Spurious emissions	Pass
11	ETSI EN 300 328 4.3.1.12	Receiver Blocking	Pass

Note:

1. N/A means it's not applicable to this item.
2. Owing to the maximum declared RF Output power (e.i.r.p.) less than 10 dBm, so the item 2, 5, 6 are not applicable.

2.6. ENVIRONMENTAL CONDITIONS

- Temperature: 15-35°C
- Relative Humidity: 30-60 %
- Atmospheric pressure: 86-106 kPa

Any report having not been signed by authorized approver, or having been altered without authorization, or having not been stamped by the "Dedicated Testing/Inspection Stamp" is deemed to be invalid. Copying or excerpting portion of, or altering the content of the report is not permitted without the written authorization of AGC. The test results presented in the report apply only to the tested sample. Any objections to report issued by AGC should be submitted to AGC within 15days after the issuance of the test report. Further enquiry of validity or verification of the test report should be addressed to AGC by agc01@agccert.com.

3. MEASUREMENT UNCERTAINTY

The uncertainty is calculated using the methods suggested in the “Guide to the Expression of Uncertainty in Measurement” (GUM) published by ISO.

Item	Measurement Uncertainty
Uncertainty of Radio Frequency	$U_c = \pm 1 \times 10^{-7}$
Uncertainty of total RF power, conducted	$U_c = \pm 0.8 \text{ dB}$
Uncertainty of RF power density, conducted	$U_c = \pm 2.6 \text{ dB}$
Uncertainty of spurious emissions, conducted	$U_c = \pm 2.7 \text{ dB}$
Uncertainty of spurious emissions, radiated	$U_c = \pm 5.4 \text{ dB}$
Uncertainty of Temperature	$U_c = 0.5^\circ \text{ C}$
Uncertainty of Humidity	$U_c = \pm 1 \%$
Uncertainty of DC and low frequency voltages	$U_c = \pm 2 \%$

Any report having not been signed by authorized approver, or having been altered without authorization, or having not been stamped by the “Dedicated Testing/Inspection Stamp” is deemed to be invalid. Copying or excerpting portion of, or altering the content of the report is not permitted without the written authorization of AGC. The test results presented in the report apply only to the tested sample. Any objections to report issued by AGC should be submitted to AGC within 15 days after the issuance of the test report. Further enquiry of validity or verification of the test report should be addressed to AGC by agc01@agccert.com.

4. IDENTIFICATION OF THE RESPONSIBLE TESTING LOCATION

Site	Attestation of Global Compliance (Shenzhen) Co., Ltd.
Location	1-2/F, Building 19, Junfeng Industrial Park, Chongqing Road, Heping Community, Fuhai Street, Bao'an District, Shenzhen, Guangdong, China

LIST OF EQUIPMENTS USED

Description	Manufacturer	Model No.	S/N	Cal. Date	Cal. Due
MXG X-Series Vector Signal Generator	Agilent	N5182B	MY53050647	Aug. 03, 2022	Aug. 02, 2023
Signal Generator	Agilent	N5171B	MY53050474	Aug. 03, 2022	Aug. 02, 2023
EXA Signal Analyzer	Agilent	N9020A	MY49100060	Aug. 04, 2022	Aug. 03, 2023
USB Wideband Power Sensor	Agilent	U2021XA	MY54110007	Mar. 03, 2023	Mar. 02, 2024
USB Wideband Power Sensor	Agilent	U2021XA	MY54110009	Mar. 03, 2023	Mar. 02, 2024
USB Wideband Power Sensor	Agilent	U2021XA	MY541100B	Feb. 18, 2023	Feb. 17, 2024
Attenuator	ZHINAN	E-002	N/A	Aug. 04, 2022	Aug. 03, 2024
RF Communication Tester	R&S	CMW270	101933	Aug. 03, 2022	Aug. 02, 2023
Attenuator	Warriors	W13	11324	N/A	N/A
Power splitter	Mini-Circuits	ZFRSC-183-s	3122	N/A	N/A
2.4G Band Filter	EM Electronics	2400-2500	N/A	Mar. 22, 2022	Mar. 21, 2024
Small environment tester	ESPEC	SH-242	93008290	Aug. 03, 2022	Aug. 02, 2024
AMPLIFIER	ETS-LINDGREN	3117PA	00225134	Sep. 02, 2022	Sep. 01, 2024
ANTENNA	SCHWARZBECK	VULB9168	494	Jan. 05, 2023	Jan. 04, 2025
Biconilog Antenna	ETS-LINDGREN	3142C	00060447	N/A	N/A
HORN ANTENNA	ETS-LINDGREN	3117	00154520	Sep. 06, 2021	Sep. 05, 2023
Double-Ridged Waveguide Horn	ETS-LINDGREN	3117	00034609	Mar. 23, 2023	Mar. 22, 2024
RF Cable	Harbour	FLCA-7312-80-10000S2	FL0000169	Nov. 11, 2022	Nov. 10, 2024

Any report having not been signed by authorized approver, or having been altered without authorization, or having not been stamped by the "Dedicated Testing/Inspection Stamp" is deemed to be invalid. Copying or excerpting portion of, or altering the content of the report is not permitted without the written authorization of AGC. The test results presented in the report apply only to the tested sample. Any objections to report issued by AGC should be submitted to AGC within 15days after the issuance of the test report. Further enquiry of validity or verification of the test report should be addressed to AGC by agc01@agccert.com.

5. ETSI EN 300 328 REQUIREMENTS

5.1. RF OUTPUT POWER

5.1.1 LIMIT

RF Output Power \leq 100mW (20dBm) over Normal and Extreme conditions.

5.1.2 MEASUREMENT PROCEDURE

- 1) Use a fast power sensor and set the samples speed 1MS/s or faster.
- 2) Connect one power sensor to each transmit port, Trigger the power sensors so that they start sampling at the same time. For each instant in time, sum the power of the individual samples of all ports and store them. Use these stored samples in all following steps.
- 3) Find the start and stop times of each burst in the stored measurement samples.
- 4) Between the start and stop times of each individual burst calculate the RMS power over the burst. Save these P burst values, as well as the start and stop times for each burst.
- 5) The highest of all P burst values (Value "A" in dBm) will be used for maximum e.i.r.p calculations.
- 6) The cable loss and attenuator factor shall be considered to the value "A".
- 6) Add the (stated) antenna assembly gain "G" in dBi of the individual antenna. If applicable, add the additional beamforming gain "Y" in dB.
- 7) The RF output power (P) shall be calculated using the formula: $P=A+G+Y$

5.1.3 TEST CONFIGURATION

Temperature and Voltage Measurement (under normal and extreme test conditions)

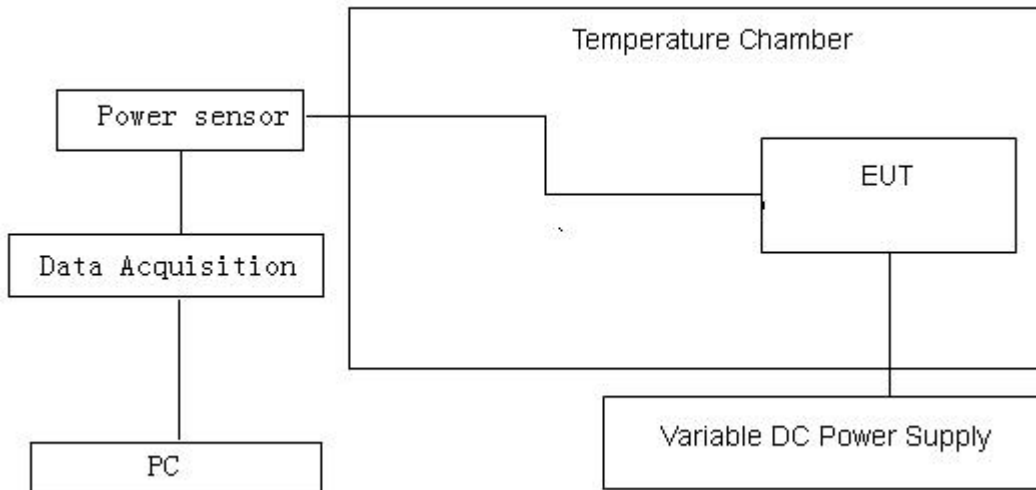

Any report having not been signed by authorized approver, or having been altered without authorization, or having not been stamped by the "Dedicated Testing/Inspection Stamp" is deemed to be invalid. Copying or excerpting portion of, or altering the content of the report is not permitted without the written authorization of AGC. The test results presented in the report apply only to the tested sample. Any objections to report issued by AGC should be submitted to AGC within 15days after the issuance of the test report. Further enquiry of validity or verification of the test report should be addressed to AGC by agc01@agccert.com.

5.1.4 MEASUREMENT RESULTS

Test Data of RF Output Power					
Test Mode	RF Output Power [dBm]			Limit [dBm]	Verdict
	NT	LT	HT		
BR_HOP_NA_1Mbps	-0.17	-0.16	-0.15	20	Pass
EDR_HOP_NA_2Mbps	-2.05	-2.16	-2.39	20	Pass
EDR_HOP_NA_3Mbps	-2.23	-2.09	-2.17	20	Pass

Any report having not been signed by authorized approver, or having been altered without authorization, or having not been stamped by the "Dedicated Testing/Inspection Stamp" is deemed to be invalid. Copying or excerpting portion of, or altering the content of the report is not permitted without the written authorization of AGC. The test results presented in the report apply only to the tested sample. Any objections to report issued by AGC should be submitted to AGC within 15days after the issuance of the test report. Further enquiry of validity or verification of the test report should be addressed to AGC by agc01@agccert.com.

Test Graphs of RF Output Power

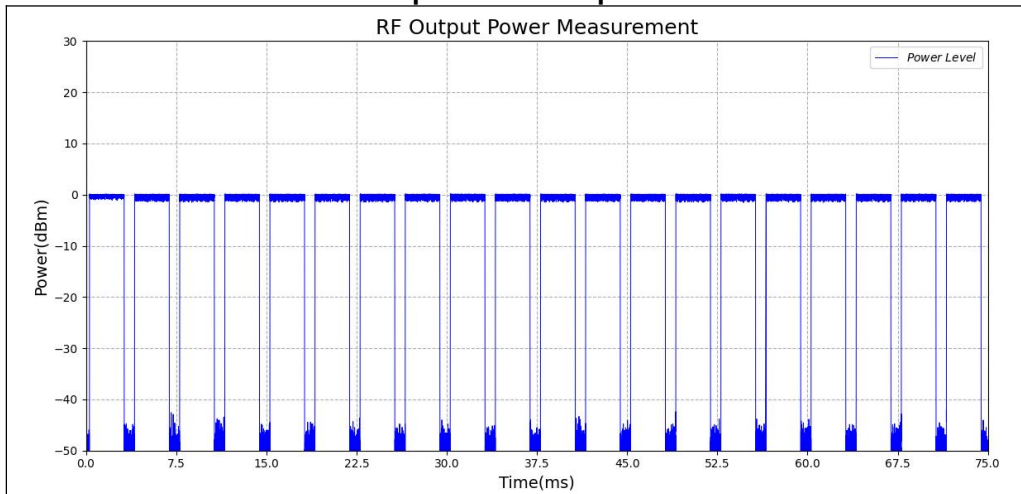

Test_Graph_BR_HOP_NA_1Mbps_Power_NT

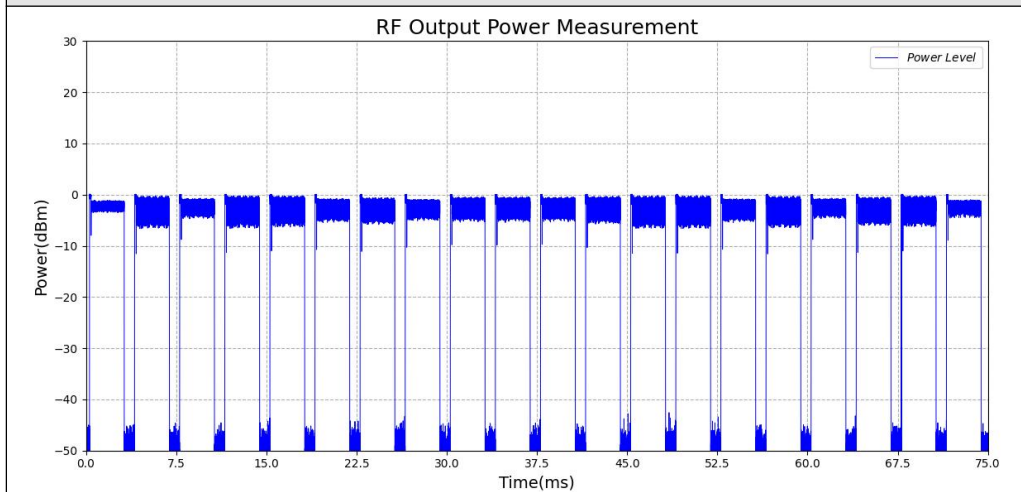

Test_Graph_EDR_HOP_NA_2Mbps_Power_NT

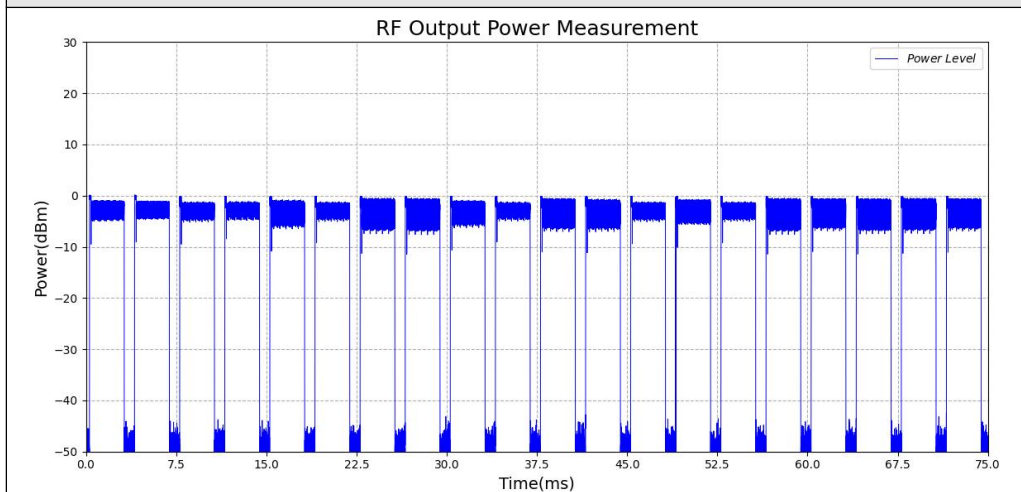

Test_Graph_EDR_HOP_NA_3Mbps_Power_NT

Note: Only the data of worst case is reported as above.

Any report having not been signed by authorized approver, or having been altered without authorization, or having not been stamped by the "Dedicated Testing/Inspection Stamp" is deemed to be invalid. Copying or excerpting portion of, or altering the content of the report is not permitted without the written authorization of AGC. The test results presented in the report apply only to the tested sample. Any objections to report issued by AGC should be submitted to AGC within 15days after the issuance of the test report. Further enquiry of validity or verification of the test report should be addressed to AGC by agc01@agccert.com.

5.2. ACCUMULATED TRANSMIT TIME, FREQUENCY OCCUPIATION AND HOPPING SEQUENCE

5.2.1 LIMIT

ACCUMULATED TRANSMIT TIME	
CONDITION	LIMIT
<input type="checkbox"/> Non-adaptive frequency hopping systems	≤ 15 ms
<input checked="" type="checkbox"/> Adaptive frequency hopping systems	≤ 400 ms

FREQUENCY OCCUPATION	
CONDITION	LIMIT (OPTION 1)
<input type="checkbox"/> Non-adaptive frequency hopping systems	Each hopping frequency of the hopping sequence shall be occupied at least once within a period not exceeding four times the product of the dwell time and the number of hopping frequencies in use.
<input checked="" type="checkbox"/> Adaptive frequency hopping systems	

HOPPING SEQUENCE(S)	
CONDITION	LIMIT
<input type="checkbox"/> Non-adaptive frequency hopping systems	≥5 hopping frequencies or 5/minimum Hopping Frequency Separation in MHz, whichever is the greater.
<input checked="" type="checkbox"/> Adaptive frequency hopping systems	Operating frequency band ≥58.45MHz (Operating over a minimum of 70 % of the operating in the band 2,4 GHz to 2,4835 GHz)
	≥15 hopping frequencies or 15/minimum Hopping Frequency Separation in MHz, whichever is the greater.

5.2.2 TEST PROCEDURE

Please refer to ETSI EN300328 V2.2.2 Section 5.4.4

5.2.3 TEST CONFIGURATION

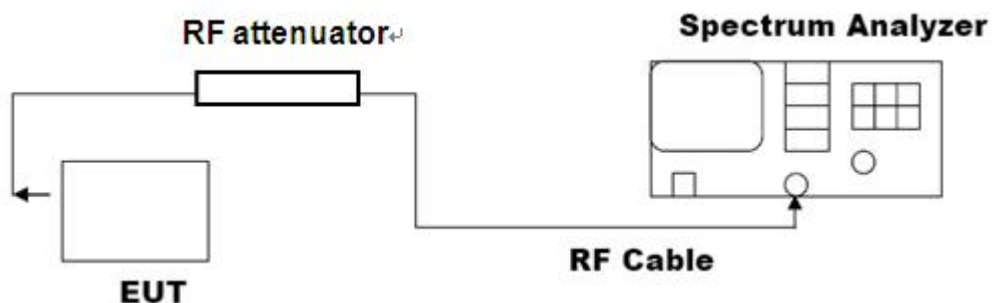

Any report having not been signed by authorized approver, or having been altered without authorization, or having not been stamped by the "Dedicated Testing/Inspection Stamp" is deemed to be invalid. Copying or excerpting portion of, or altering the content of the report is not permitted without the written authorization of AGC. The test results presented in the report apply only to the tested sample. Any objections to report issued by AGC should be submitted to AGC within 15days after the issuance of the test report. Further enquiry of validity or verification of the test report should be addressed to AGC by agc01@agccert.com.

5.2.4 TEST RESULTS

Test Data of Accumulated Transmit Time, Frequency Occupation						
Test Mode	Channel (MHz)	Accumulated transmit time (ms)	Limit (ms)	Frequency Occupation (pcs)	Limit (pcs)	Verdict
BR_HOP_NA_1Mbps	2402	299.312	≤400	2	≥1	Pass
	2480	299.312	≤400	3	≥1	Pass

Note: 1) All the modes had been tested, but only the worst data recorded in the report.

2) The Accumulated transmit time and Dwell Time are calculated by a computing device using an appropriate software application or program.

3) Sweep time for Frequency Occupation= Dwell Time*4*79.

Any report having not been signed by authorized approver, or having been altered without authorization, or having not been stamped by the "Dedicated Testing/Inspection Stamp" is deemed to be invalid. Copying or excerpting portion of, or altering the content of the report is not permitted without the written authorization of AGC. The test results presented in the report apply only to the tested sample. Any objections to report issued by AGC should be submitted to AGC within 15days after the issuance of the test report. Further enquiry of validity or verification of the test report should be addressed to AGC by agc01@agccert.com.

Attestation of Global Compliance(Shenzhen)Co., Ltd

Attestation of Global Compliance(Shenzhen)Std & Tech Co., Ltd

Tel: +86-755 2523 4088 E-mail: agc@agccert.com Web: http://www.agccert.com/

Test Graphs of Accumulated Transmit Time, Frequency Occupation

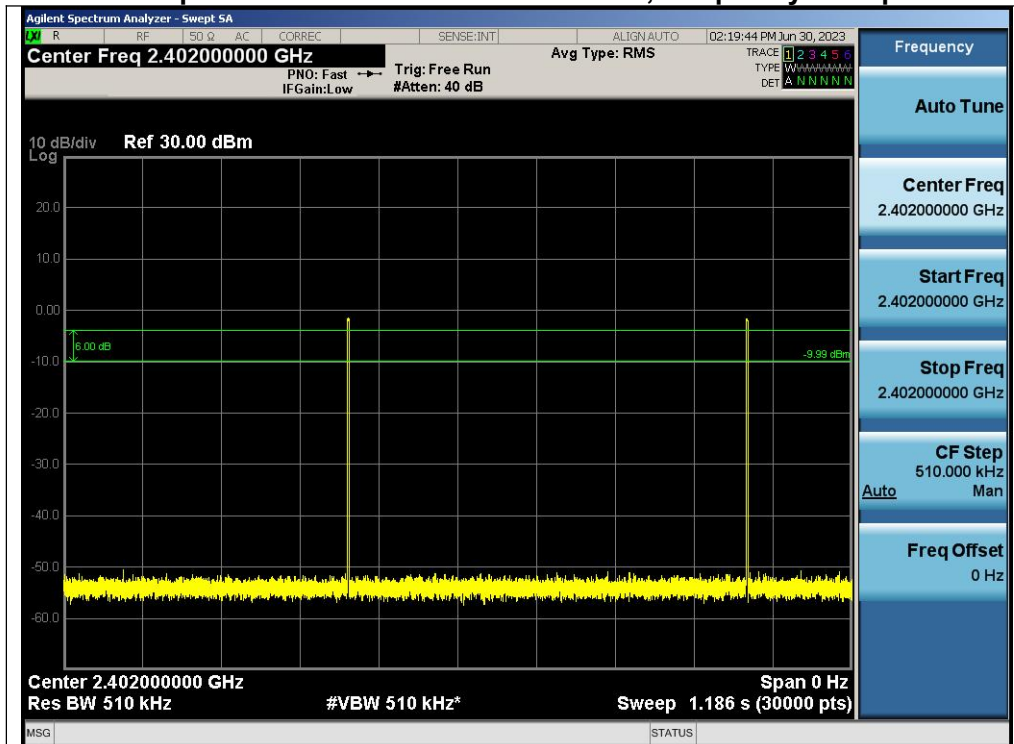

Test_Graph_BR_HOP_NA_1Mbps_2402_Frequency Occupation

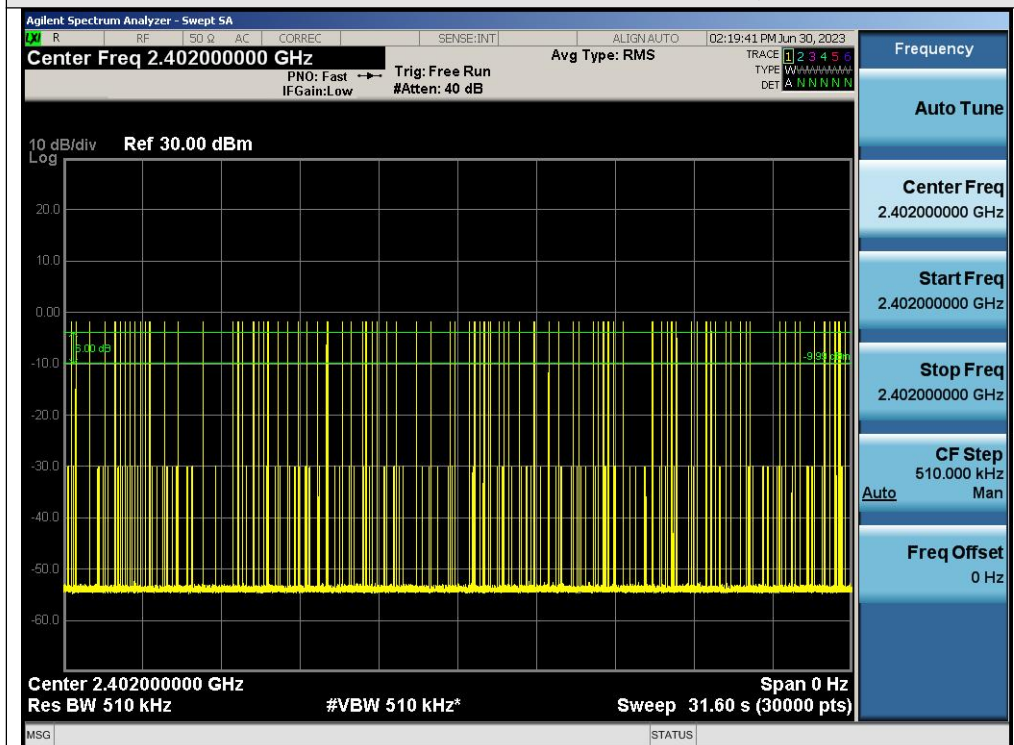

Test_Graph_BR_HOP_NA_1Mbps_2402_Accumulated Transmit Time

Any report having not been signed by authorized approver, or having been altered without authorization, or having not been stamped by the "Dedicated Testing/Inspection Stamp" is deemed to be invalid. Copying or excerpting portion of, or altering the content of the report is not permitted without the written authorization of AGC. The test results presented in the report apply only to the tested sample. Any objections to report issued by AGC should be submitted to AGC within 15days after the issuance of the test report. Further enquiry of validity or verification of the test report should be addressed to AGC by agc01@agccert.com.

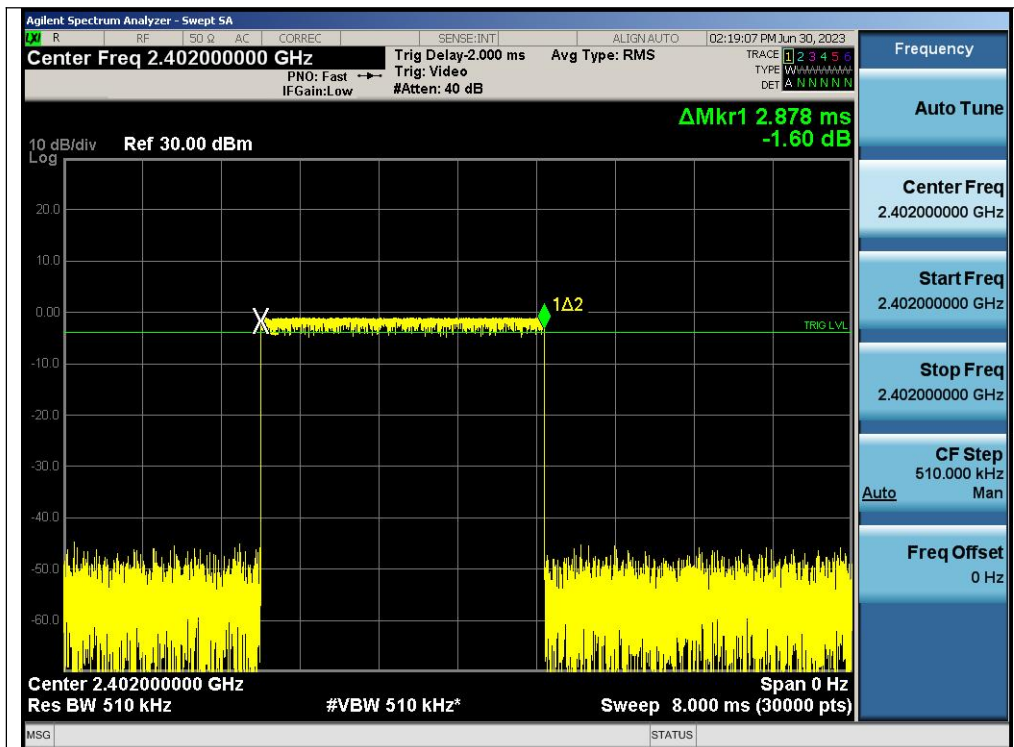

Test_Graph_BR_HOP_NA_1Mbps_2402_Burst Time

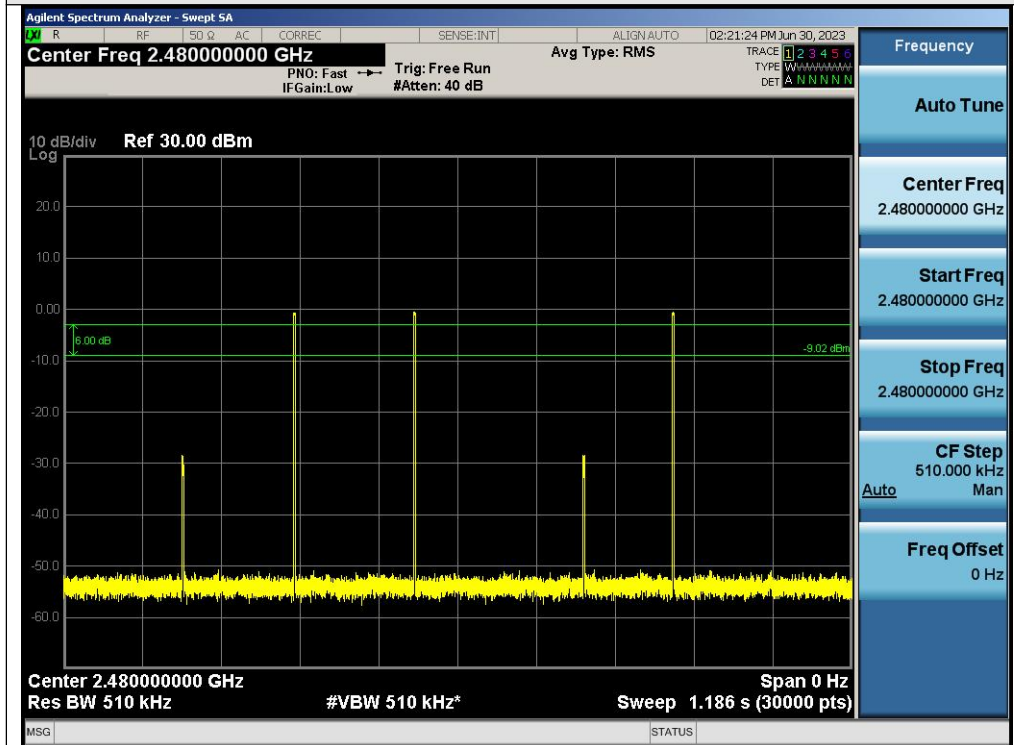

Test_Graph_BR_HOP_NA_1Mbps_2480_Frequency Occupation

Any report having not been signed by authorized approver, or having been altered without authorization, or having not been stamped by the "Dedicated Testing/Inspection Stamp" is deemed to be invalid. Copying or excerpting portion of, or altering the content of the report is not permitted without the written authorization of AGC. The test results presented in the report apply only to the tested sample. Any objections to report issued by AGC should be submitted to AGC within 15 days after the issuance of the test report. Further enquiry of validity or verification of the test report should be addressed to AGC by agc01@agccert.com.

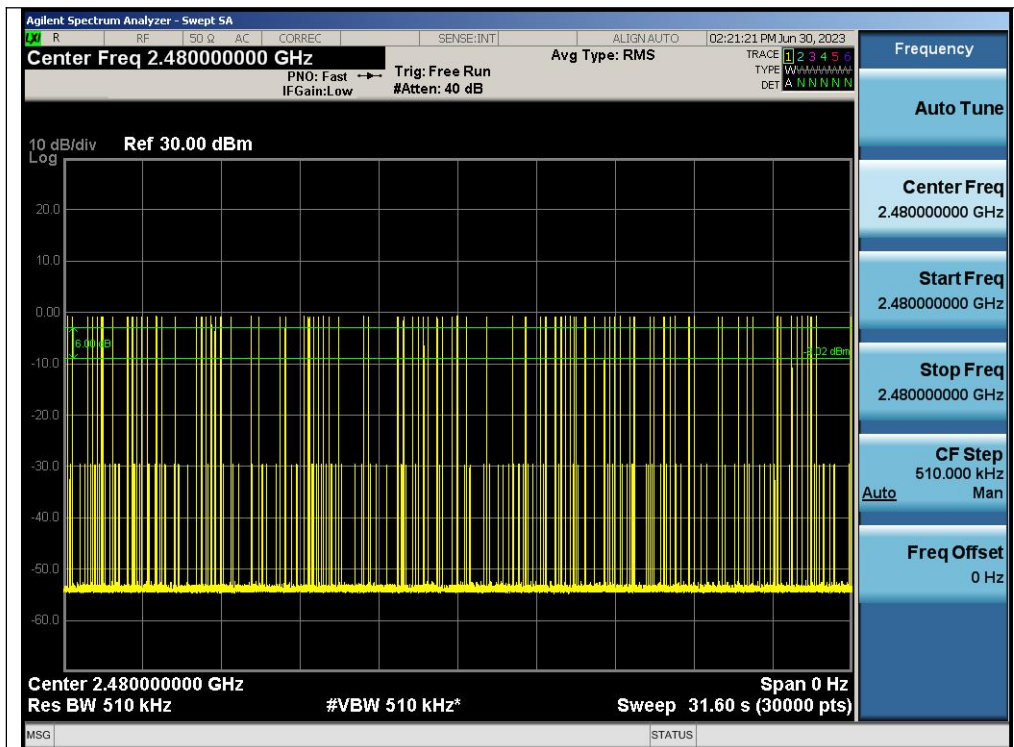

Test_Graph_BR_HOP_NA_1Mbps_2480_Accumulated Transmit Time

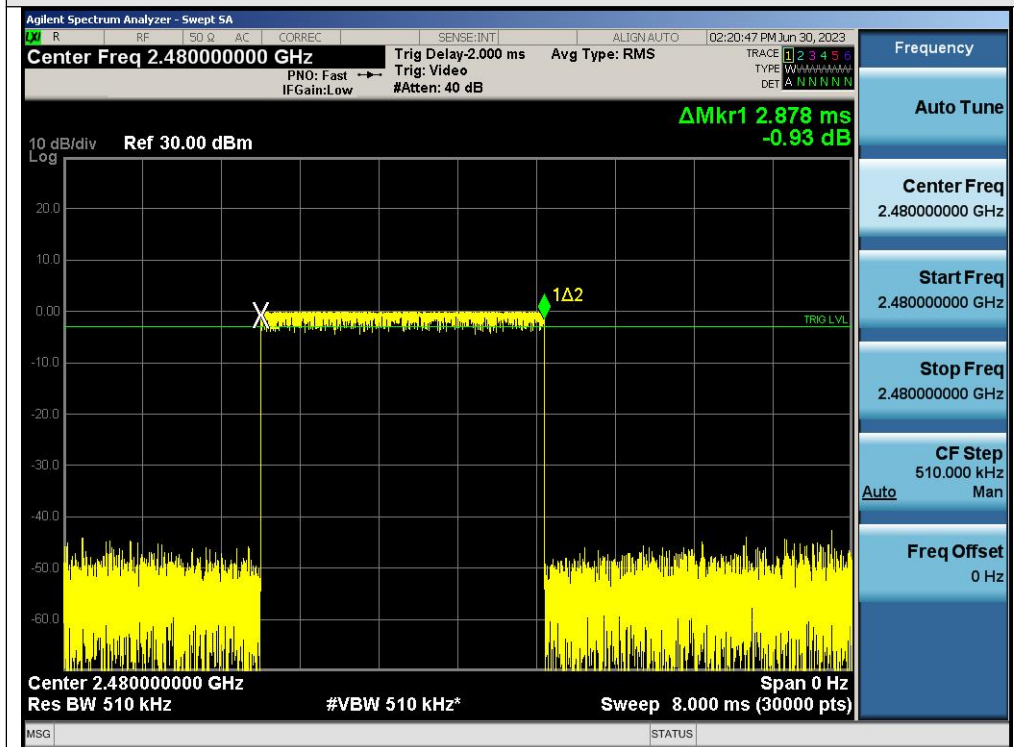

Test_Graph_BR_HOP_NA_1Mbps_2480_Burst Time

Any report having not been signed by authorized approver, or having been altered without authorization, or having not been stamped by the "Dedicated Testing/Inspection Stamp" is deemed to be invalid. Copying or excerpting portion of, or altering the content of the report is not permitted without the written authorization of AGC. The test results presented in the report apply only to the tested sample. Any objections to report issued by AGC should be submitted to AGC within 15 days after the issuance of the test report. Further enquiry of validity or verification of the test report should be addressed to AGC by agc01@agccert.com.

TEST RESULT FOR HOPPING SEQUENCE

Channel	Frequency (GHz)	Channel	Frequency (GHz)
01	2.402	42	2.443
02	2.403	43	2.444
03	2.404	44	2.445
04	2.405	45	2.446
05	2.406	46	2.447
06	2.407	47	2.448
07	2.408	48	2.449
08	2.409	49	2.450
09	2.410	50	2.451
10	2.411	51	2.452
11	2.412	52	2.453
12	2.413	53	2.454
13	2.414	54	2.455
14	2.415	55	2.456
15	2.416	56	2.457
16	2.417	57	2.458
17	2.418	58	2.459
18	2.419	59	2.460
19	2.420	60	2.461
20	2.421	61	2.462
21	2.422	62	2.463
22	2.423	63	2.464
23	2.424	64	2.465
24	2.420	65	2.466
25	2.426	66	2.467
26	2.427	67	2.468
27	2.428	68	2.469
28	2.429	69	2.470
29	2.430	70	2.471
30	2.431	71	2.472
31	2.432	72	2.473
32	2.433	73	2.474
33	2.434	74	2.475
34	2.435	75	2.476
35	2.436	76	2.477
36	2.437	77	2.478
37	2.438	78	2.479
38	2.439	79	2.480
39	2.440		
40	2.441		
41	2.442		

Any report having not been signed by authorized approver, or having been altered without authorization, or having not been stamped by the “Dedicated Testing/Inspection Stamp” is deemed to be invalid. Copying or excerpting portion of, or altering the content of the report is not permitted without the written authorization of AGC. The test results presented in the report apply only to the tested sample. Any objections to report issued by AGC should be submitted to AGC within 15days after the issuance of the test report. Further enquiry of validity or verification of the test report should be addressed to AGC by agc01@agccert.com.

Test Data of Hopping Sequence					
Test Mode	Number of hopping frequencies	Limit	-20dBc Hopping BW [MHz]	Limit [MHz]	Verdict
BR_HOP_NA_1Mbps	79	≥15	79.747	≥58.45	Pass

Test Graphs of Hopping Sequence

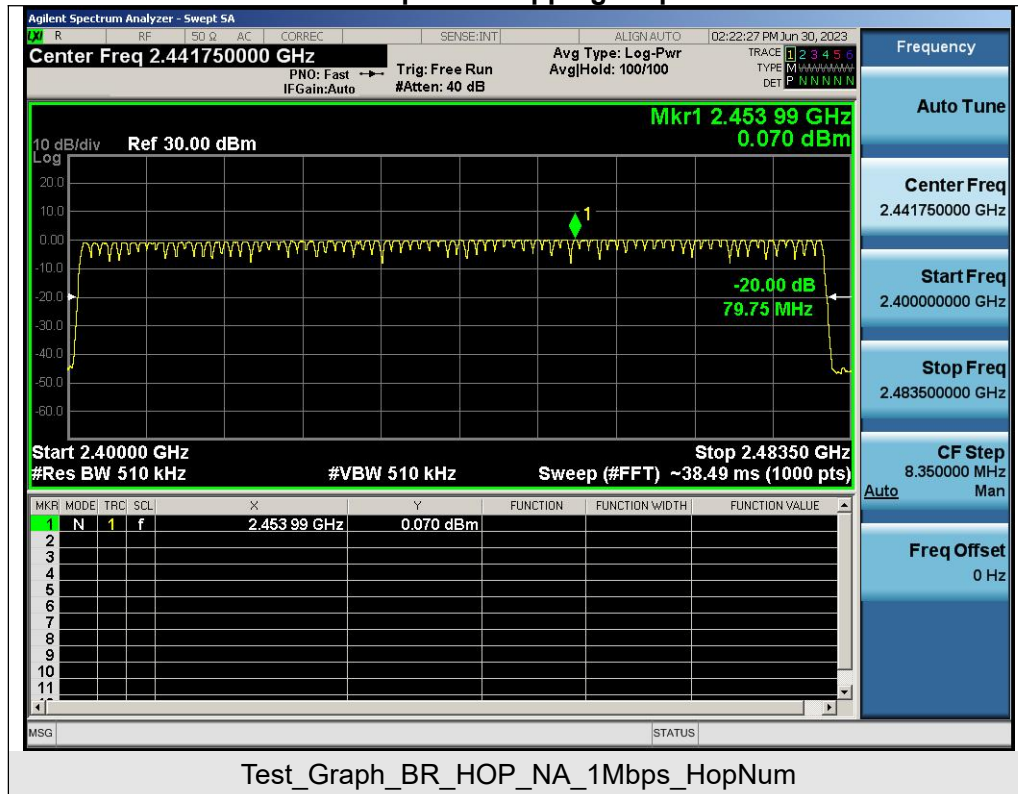

Test_Graph_BR_HOP_NA_1Mbps_HopNum

Note: The modulation used during test is GFSK and this is the worst case.

Any report having not been signed by authorized approver, or having been altered without authorization, or having not been stamped by the "Dedicated Testing/Inspection Stamp" is deemed to be invalid. Copying or excerpting portion of, or altering the content of the report is not permitted without the written authorization of AGC. The test results presented in the report apply only to the tested sample. Any objections to report issued by AGC should be submitted to AGC within 15days after the issuance of the test report. Further enquiry of validity or verification of the test report should be addressed to AGC by agc01@agccert.com.

5.3. HOPPING FREQUENCY SEPARATION

5.3.1 LIMIT

For Non-adaptive frequency hopping systems:

The minimum Hopping Frequency Separation shall be equal to Occupied Channel Bandwidth (see clause 4.3.1.7) of a single hop, with a minimum separation of 100 kHz.

For Adaptive frequency hopping systems:

The minimum Hopping Frequency Separation shall be 100 kHz.

5.2.2 TEST PROCEDURE

Please refer to ETSI EN300328 V2.2.2 Section 5.4.5

5.2.3 TEST CONFIGURATION

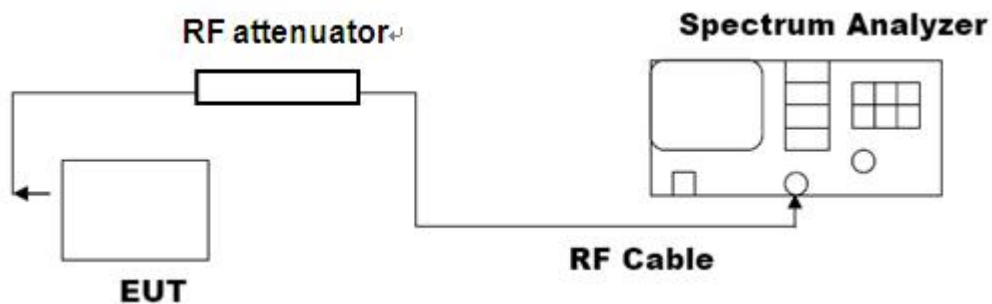

Any report having not been signed by authorized approver, or having been altered without authorization, or having not been stamped by the "Dedicated Testing/Inspection Stamp" is deemed to be invalid. Copying or excerpting portion of, or altering the content of the report is not permitted without the written authorization of AGC. The test results presented in the report apply only to the tested sample. Any objections to report issued by AGC should be submitted to AGC within 15days after the issuance of the test report. Further enquiry of validity or verification of the test report should be addressed to AGC by agc01@agccert.com.

Attestation of Global Compliance(Shenzhen)Co., Ltd

Attestation of Global Compliance(Shenzhen)Std & Tech Co., Ltd

Tel: +86-755 2523 4088 E-mail: agc@agccert.com Web: <http://www.agccert.com/>

5.3.4 TEST RESULTS

Test Data of Hopping Frequency Separation			
Test Mode	Hopping Frequency Separation [MHz]	Limit [MHz]	Verdict
BR_HOP_NA_1Mbps	0.989	≥0.1	Pass

Test Graphs of Hopping Sequence



Test_Graph_BR_HOP_NA_1Mbps_HopSep

Note: The modulation used during test is GFSK and this is the worst case.

Any report having not been signed by authorized approver, or having been altered without authorization, or having not been stamped by the “Dedicated Testing/Inspection Stamp” is deemed to be invalid. Copying or excerpting portion of, or altering the content of the report is not permitted without the written authorization of AGC. The test results presented in the report apply only to the tested sample. Any objections to report issued by AGC should be submitted to AGC within 15days after the issuance of the test report. Further enquiry of validity or verification of the test report should be addressed to AGC by agc01@agccert.com.

5.4. OCCUPIED CHANNEL BANDWIDTH

5.4.1 LIMIT

The Occupied Channel Bandwidth shall fall completely within the band 2400MHz to 2483.5MHz.

5.4.2 TEST PROCEDURE

1) The spectrum analyser shall be used the following settings:

Centre Frequency: The centre frequency of the channel under test

Resolution BW: ~1% of the span without going below 1%

Video BW: 3×RBW

Span: 2×OBW

Detector: RMS

Trace mode: Max Hold

2) Wait until the trace is completed, find the peak value of the trace and place the analyser marker on this peak.

3) Use the 99 % bandwidth function of the spectrum analyser to measure the Occupied Channel Bandwidth of the UUT. This value shall be recorded.

5.4.3 TEST CONFIGURATION

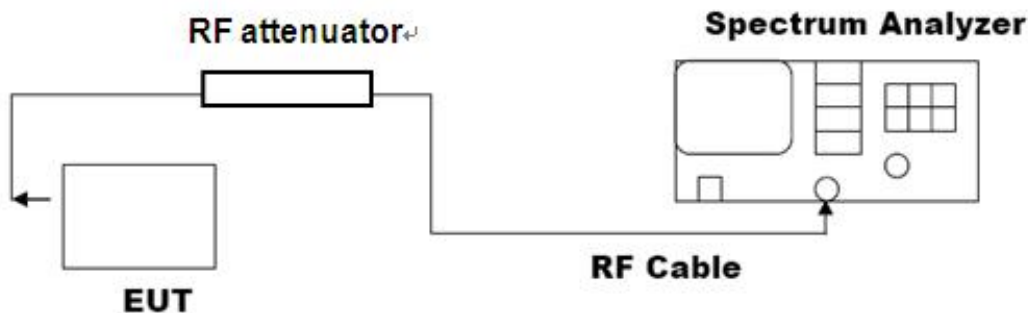

5.4.4 TEST RESULTS

Test Data of Occupied Channel Bandwidth					
Test Mode	Occupied Channel Bandwidth [MHz]			Limit [MHz]	Verdict
	OCB	FL	FH		
BR_2402_1Mbps	0.981	2401.498	2402.480	2400 to 2483.5	Pass
BR_2480_1Mbps	0.996	2479.490	2480.487	2400 to 2483.5	Pass
EDR_2402_2Mbps	1.231	2401.379	2402.609	2400 to 2483.5	Pass
EDR_2480_2Mbps	1.253	2479.366	2480.618	2400 to 2483.5	Pass
EDR_2402_3Mbps	1.236	2401.365	2402.602	2400 to 2483.5	Pass
EDR_2480_3Mbps	1.242	2479.363	2480.605	2400 to 2483.5	Pass

Any report having not been signed by authorized approver, or having been altered without authorization, or having not been stamped by the "Dedicated Testing/Inspection Stamp" is deemed to be invalid. Copying or excerpting portion of, or altering the content of the report is not permitted without the written authorization of AGC. The test results presented in the report apply only to the tested sample. Any objections to report issued by AGC should be submitted to AGC within 15days after the issuance of the test report. Further enquiry of validity or verification of the test report should be addressed to AGC by agc01@agccert.com.

Attestation of Global Compliance(Shenzhen)Co., Ltd

Attestation of Global Compliance(Shenzhen)Std & Tech Co., Ltd

Tel: +86-755 2523 4088 E-mail: agc@agccert.com Web: http://www.agccert.com/

Test Graphs of Occupied Channel Bandwidth



Test_Graph_BR_2402_1Mbps_OBW

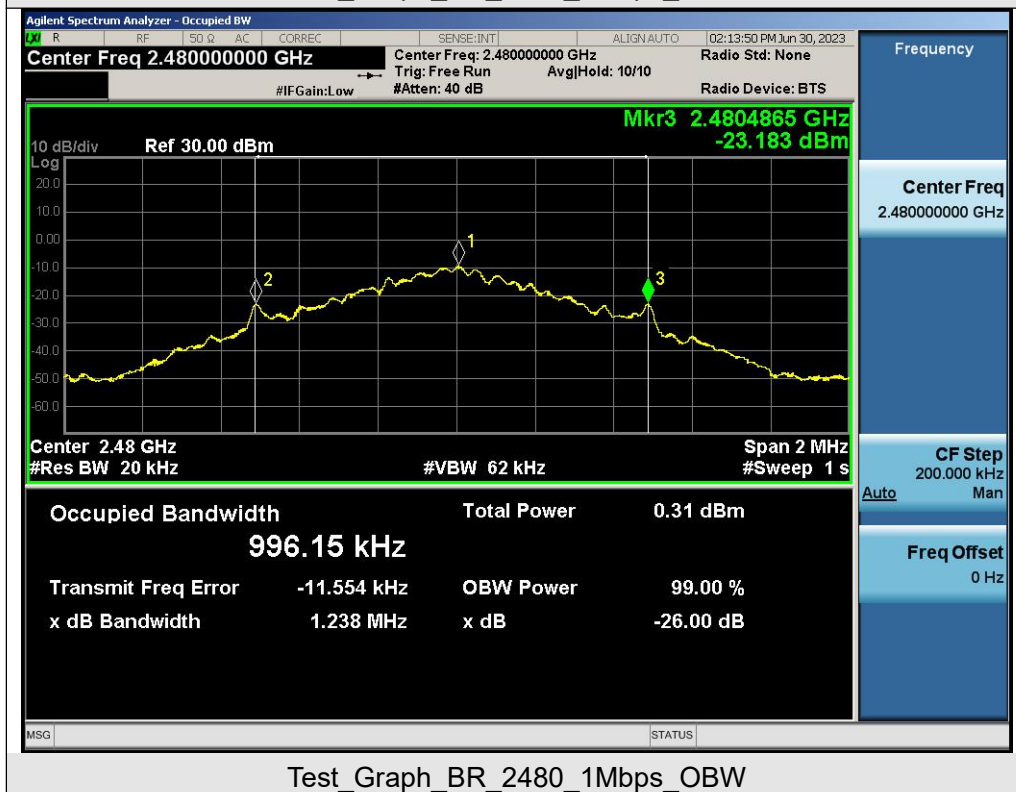

Test_Graph_BR_2480_1Mbps_OBW

Any report having not been signed by authorized approver, or having been altered without authorization, or having not been stamped by the "Dedicated Testing/Inspection Stamp" is deemed to be invalid. Copying or excerpting portion of, or altering the content of the report is not permitted without the written authorization of AGC. The test results presented in the report apply only to the tested sample. Any objections to report issued by AGC should be submitted to AGC within 15days after the issuance of the test report. Further enquiry of validity or verification of the test report should be addressed to AGC by agc01@agccert.com.



Test_Graph_EDR_2402_2Mbps_OBW

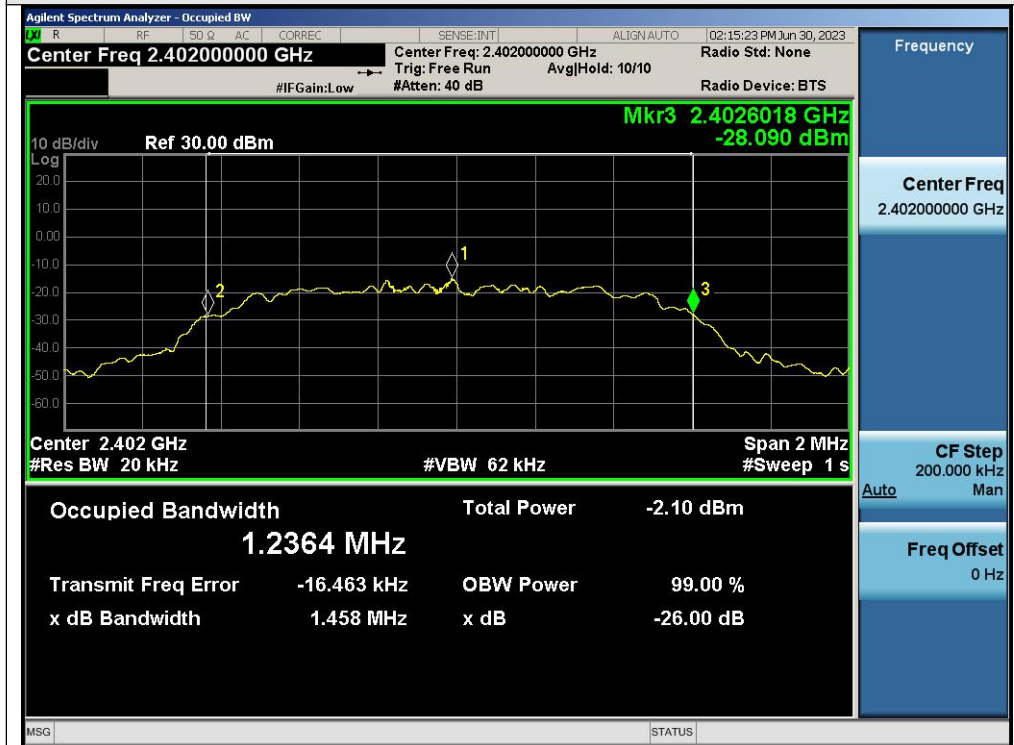

Test_Graph_EDR_2402_3Mbps_OBW

Any report having not been signed by authorized approver, or having been altered without authorization, or having not been stamped by the "Dedicated Testing/Inspection Stamp" is deemed to be invalid. Copying or excerpting portion of, or altering the content of the report is not permitted without the written authorization of AGC. The test results presented in the report apply only to the tested sample. Any objections to report issued by AGC should be submitted to AGC within 15days after the issuance of the test report. Further enquiry of validity or verification of the test report should be addressed to AGC by agc01@agccert.com.

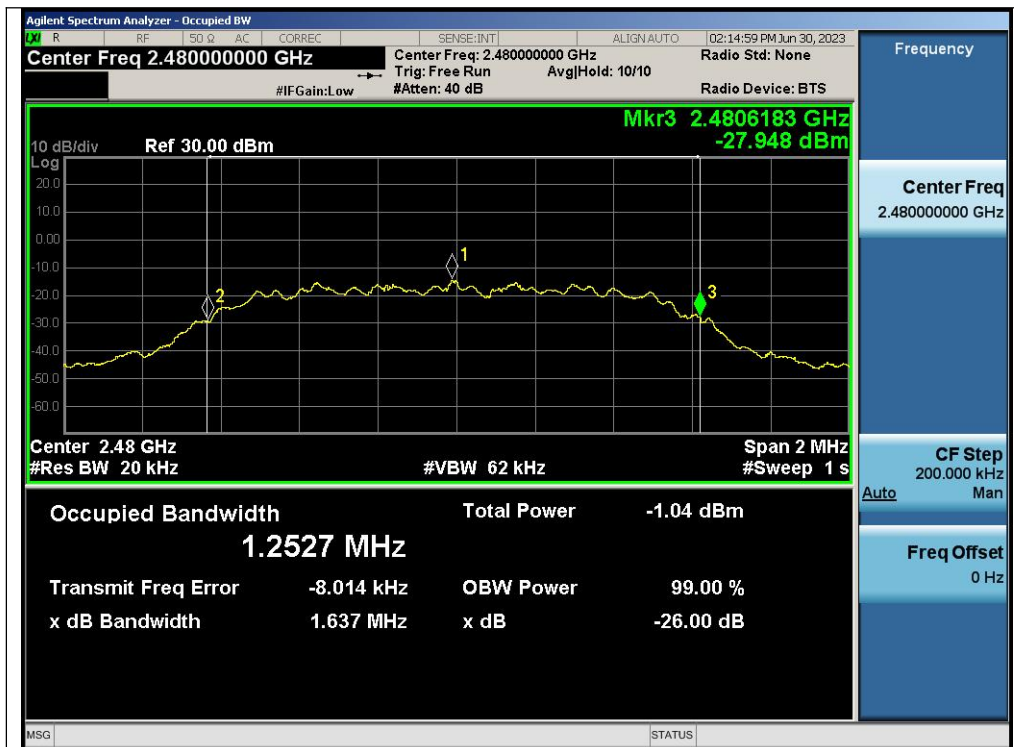

Test_Graph_EDR_2480_2Mbps_OBW

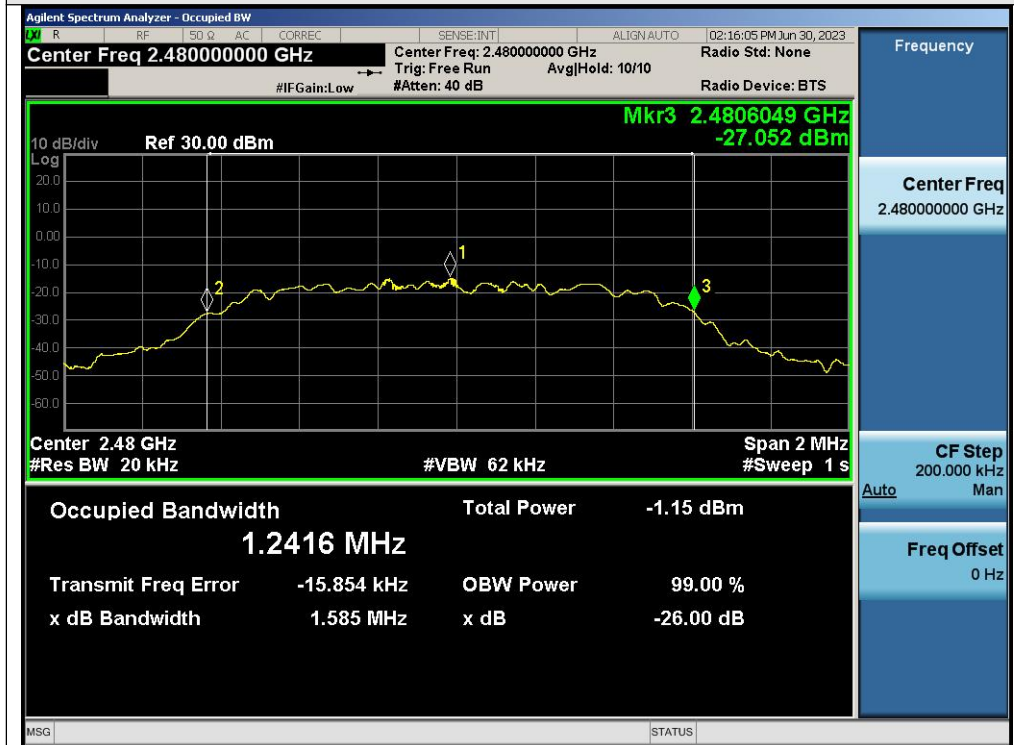

Test_Graph_EDR_2480_3Mbps_OBW

Any report having not been signed by authorized approver, or having been altered without authorization, or having not been stamped by the "Dedicated Testing/Inspection Stamp" is deemed to be invalid. Copying or excerpting portion of, or altering the content of the report is not permitted without the written authorization of AGC. The test results presented in the report apply only to the tested sample. Any objections to report issued by AGC should be submitted to AGC within 15days after the issuance of the test report. Further enquiry of validity or verification of the test report should be addressed to AGC by agc01@agccert.com.

5.5. TRANSMITTER UNWANTED EMISSIONS IN THE OUT OF BAND DOMAIN

5.5.1 LIMIT

The transmitter unwanted emissions in the out-of-band domain but outside the allocated band, shall not exceed the values provided by the mask.

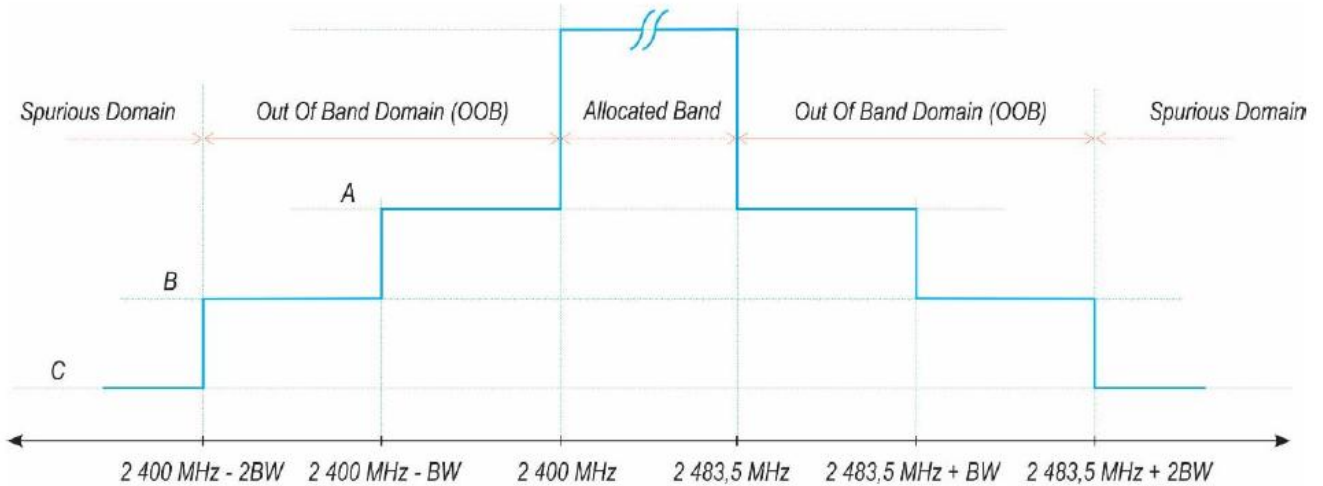

- A: -10 dBm/MHz e.i.r.p.
- B: -20 dBm/MHz e.i.r.p.
- C: Spurious Domain limits

BW = Occupied Channel Bandwidth in MHz or 1 MHz whichever is greater

Any report having not been signed by authorized approver, or having been altered without authorization, or having not been stamped by the "Dedicated Testing/Inspection Stamp" is deemed to be invalid. Copying or excerpting portion of, or altering the content of the report is not permitted without the written authorization of AGC. The test results presented in the report apply only to the tested sample. Any objections to report issued by AGC should be submitted to AGC within 15days after the issuance of the test report. Further enquiry of validity or verification of the test report should be addressed to AGC by agc01@agccert.com.

5.5.2 TEST PROCEDURE

1) The spectrum analyser shall be used the following settings:

Centre Frequency: 2484MHz

Resolution BW: 1MHz; Video BW: 3MHz; Span: 0Hz; Detector: RMS

Trace mode: Max Hold; Sweep Points: 5000

2) (segment 2 483.5 MHz to 2 483.5 MHz + BW)

Adjust the trigger level to select the transmissions with the highest power level.

Increase the centre frequency in steps of 1 MHz and repeat this measurement for every 1 MHz segment within the range 2 483.5 MHz to 2 483.5 MHz + BW.

3)Segment 2 483.5 MHz + BW to 2 483.5 MHz + 2BW

Change the centre frequency of the analyser to 2 484 MHz + BW and perform the measurement for the first 1 MHz segment within range 2 483.5 MHz + BW to 2 483.5 MHz + 2BW. Increase the centre frequency in 1 MHz steps and repeat the measurements to cover this whole range. The centre frequency of the last 1 MHz segment shall be set to 2 483,5 MHz + 2 BW – 0.5 MHz.

4)Segment 2 400 MHz - BW to 2 400 MHz

Change the centre frequency of the analyser to 2 399.5 MHz and perform the measurement for the first 1 MHz segment within range 2 400 MHz - BW to 2 400 MHz Reduce the centre frequency in 1 MHz steps and repeat the measurements to cover this whole range. The centre frequency of the last 1 MHz segment shall be set to 2 400 MHz - 2BW + 0.5 MHz.

5)Segment 2 400 MHz - 2BW to 2 400 MHz - BW

Change the centre frequency of the analyser to 2 399,5 MHz - BW and perform the measurement for the first 1 MHz segment within range 2 400 MHz - 2BW to 2 400 MHz - BW. Reduce the centre frequency in 1 MHz steps and repeat the measurements to cover this whole range. The centre frequency of the last 1 MHz segment shall be set to 2 400 MHz - 2BW + 0.5 MHz.

6)The cable loss and attenuator factor shall be considered to the test result.

5.5.3 TEST CONFIGURATION

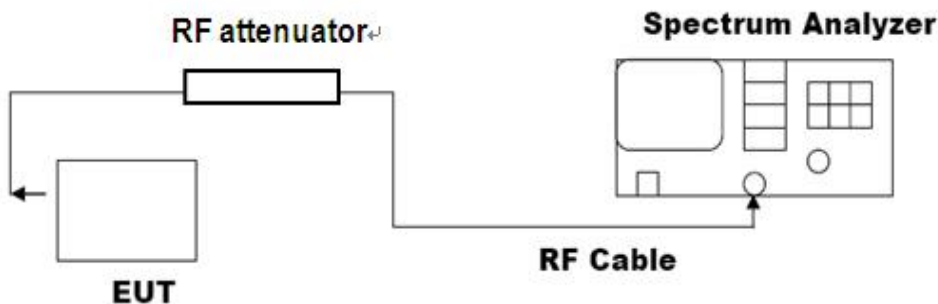

Any report having not been signed by authorized approver, or having been altered without authorization, or having not been stamped by the “Dedicated Testing/Inspection Stamp” is deemed to be invalid. Copying or excerpting portion of, or altering the content of the report is not permitted without the written authorization of AGC. The test results presented in the report apply only to the tested sample. Any objections to report issued by AGC should be submitted to AGC within 15days after the issuance of the test report. Further enquiry of validity or verification of the test report should be addressed to AGC by agc01@agccert.com.

5.5.4 TEST RESULT

Test Data of OOB Emissions				
Test Mode	Frequency [MHz]	Level [dBm]	Limit [dBm]	Verdict
BR_HOP_NA_1Mbps	2399.500	-44.18	-10	Pass
	2398.500	-48.09	-20	Pass
	2484.000	-47.99	-10	Pass
	2485.000	-48.32	-20	Pass

Test Graphs of OOB Emissions

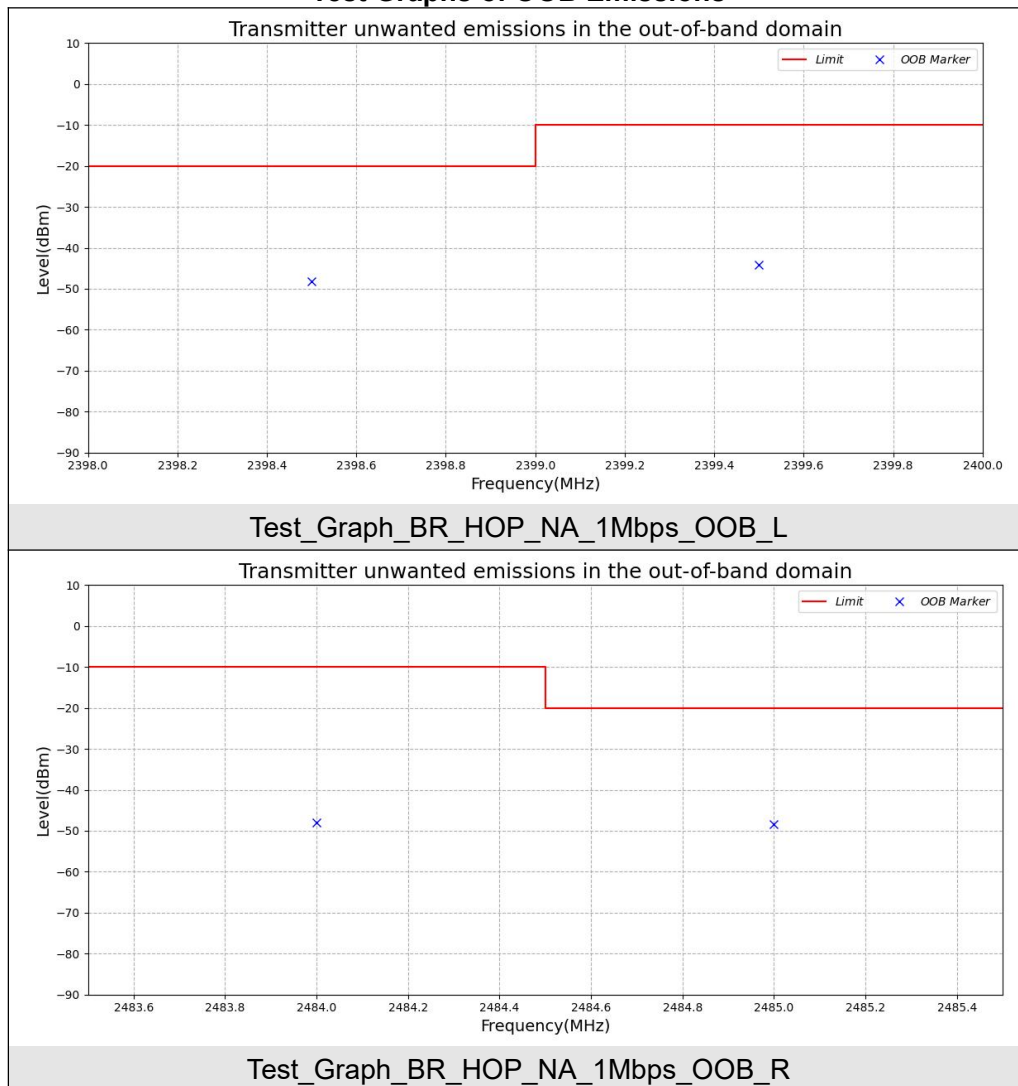

Note: All the modes had been tested, but only the worst data recorded in the report.

Any report having not been signed by authorized approver, or having been altered without authorization, or having not been stamped by the "Dedicated Testing/Inspection Stamp" is deemed to be invalid. Copying or excerpting portion of, or altering the content of the report is not permitted without the written authorization of AGC. The test results presented in the report apply only to the tested sample. Any objections to report issued by AGC should be submitted to AGC within 15days after the issuance of the test report. Further enquiry of validity or verification of the test report should be addressed to AGC by agc01@agccert.com.

5.6. TRANSMITTER SPURIOUS EMISSIONS

5.6.1 LIMIT

The spurious emissions of the transmitter shall not exceed the values in tables in the indicated bands:

Frequency Range	Maximum Power e.r.p(<=1GHz)/e.i.r.p(>1GHz)	Bandwidth
30 MHz to 47 MHz	-36dBm	100kHz
47 MHz to 74 MHz	-54dBm	100kHz
74 MHz to 87.5 MHz	-36dBm	100kHz
87.5 MHz to 118 MHz	-54dBm	100kHz
118 MHz to 174 MHz	-36dBm	100kHz
174 MHz to 230 MHz	-54dBm	100kHz
230 MHz to 470 MHz	-36dBm	100kHz
470 MHz to 694 MHz	-54dBm	100kHz
694 MHz to 1GHz	-36dBm	100kHz
1 GHz to 12.75 GHz	-30dBm	1MHz

Any report having not been signed by authorized approver, or having been altered without authorization, or having not been stamped by the "Dedicated Testing/Inspection Stamp" is deemed to be invalid. Copying or excerpting portion of, or altering the content of the report is not permitted without the written authorization of AGC. The test results presented in the report apply only to the tested sample. Any objections to report issued by AGC should be submitted to AGC within 15days after the issuance of the test report. Further enquiry of validity or verification of the test report should be addressed to AGC by agc01@agccert.com.

5.6.2 TEST PROCEDURE

- 1) The emissions over the range 30 MHz to 1 000 MHz shall be identified.
- 2) Spectrum analyzer settings:
 - Resolution bandwidth: 100 kHz
 - Video bandwidth: 300 kHz
 - Detector mode: Peak
 - Sweep Points: $\geq 19\,400$
 - Trace Mode: Max Hold
- 3) Allow the trace to stabilize. Any emissions identified during the sweeps above and that fall within the 6 dB range below the applicable limit or above, shall be individually measured using RMS detector and compared to the limits.
- 4) The emissions over the range 1 GHz to 12,75 GHz shall be identified.
- 5) Resolution bandwidth: 1 MHz
 - Video bandwidth: 3 MHz
 - Detector mode: Peak
 - Trace Mode: Max Hold
 - Sweep Points: $\geq 23\,500$
- 6) Allow the trace to stabilize. Any emissions identified during the sweeps above and that fall within the 6 dB range below the applicable limit or above, shall be individually measured using RMS detector and compared to the limits.
- 7) For radiated method, the applicable measurement procedures as described in the EN 300 328 V2.2.2 annex C.2 and C.4 are used.

Any report having not been signed by authorized approver, or having been altered without authorization, or having not been stamped by the "Dedicated Testing/Inspection Stamp" is deemed to be invalid. Copying or excerpting portion of, or altering the content of the report is not permitted without the written authorization of AGC. The test results presented in the report apply only to the tested sample. Any objections to report issued by AGC should be submitted to AGC within 15 days after the issuance of the test report. Further enquiry of validity or verification of the test report should be addressed to AGC by agc01@agccert.com.

5.6.3 TEST CONFIGURATION

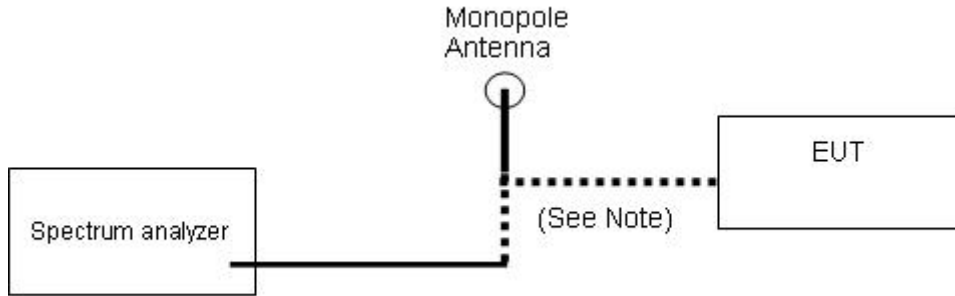

Conducted Method

Below 1GHz

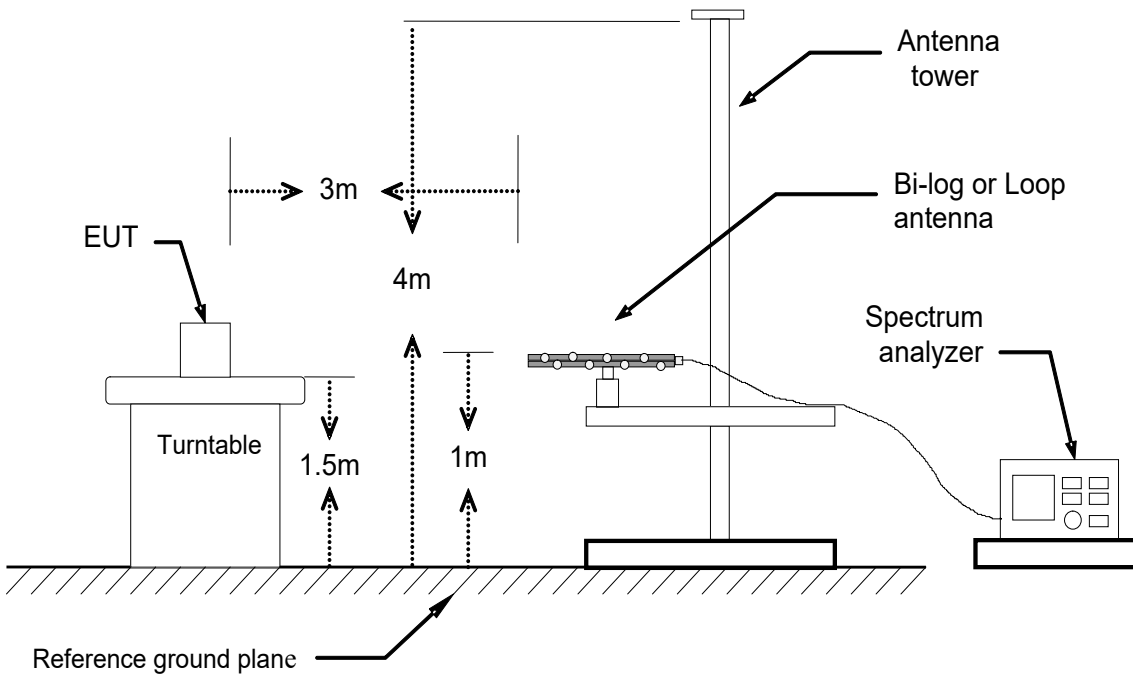

Any report having not been signed by authorized approver, or having been altered without authorization, or having not been stamped by the "Dedicated Testing/Inspection Stamp" is deemed to be invalid. Copying or excerpting portion of, or altering the content of the report is not permitted without the written authorization of AGC. The test results presented in the report apply only to the tested sample. Any objections to report issued by AGC should be submitted to AGC within 15days after the issuance of the test report. Further enquiry of validity or verification of the test report should be addressed to AGC by agc01@agccert.com.

Above 1GHz

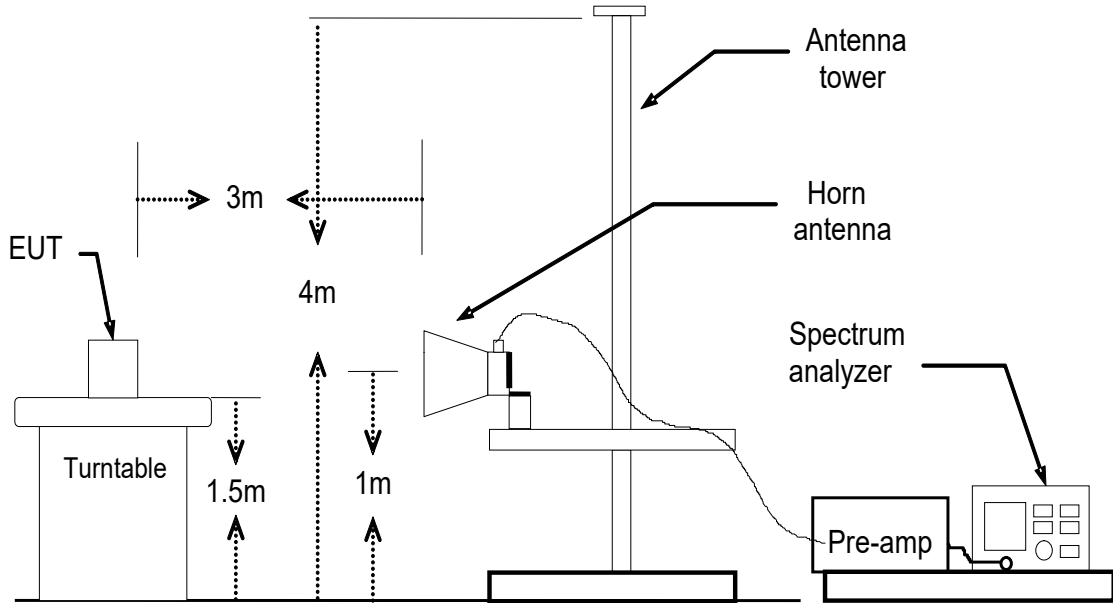

Radiated Method

Any report having not been signed by authorized approver, or having been altered without authorization, or having not been stamped by the “Dedicated Testing/Inspection Stamp” is deemed to be invalid. Copying or excerpting portion of, or altering the content of the report is not permitted without the written authorization of AGC. The test results presented in the report apply only to the tested sample. Any objections to report issued by AGC should be submitted to AGC within 15days after the issuance of the test report. Further enquiry of validity or verification of the test report should be addressed to AGC by agc01@agccert.com.

5.6.4 TEST RESULT

Test Data of Transmitter Spurious Emissions (Conducted Method)					
Test Mode	Detector	Frequency [MHz]	Level [dBm]	Limit [dBm]	Verdict
BR_2402_1Mbps	Peak	47.978	-62.89	-54.00	Pass
	Peak	4803.993	-41.09	-30.00	Pass
BR_2480_1Mbps	Peak	47.978	-63.35	-54.00	Pass
	Peak	9920.897	-41.21	-30.00	Pass

Test Graphs of Transmitter Spurious Emissions (Conducted Method)

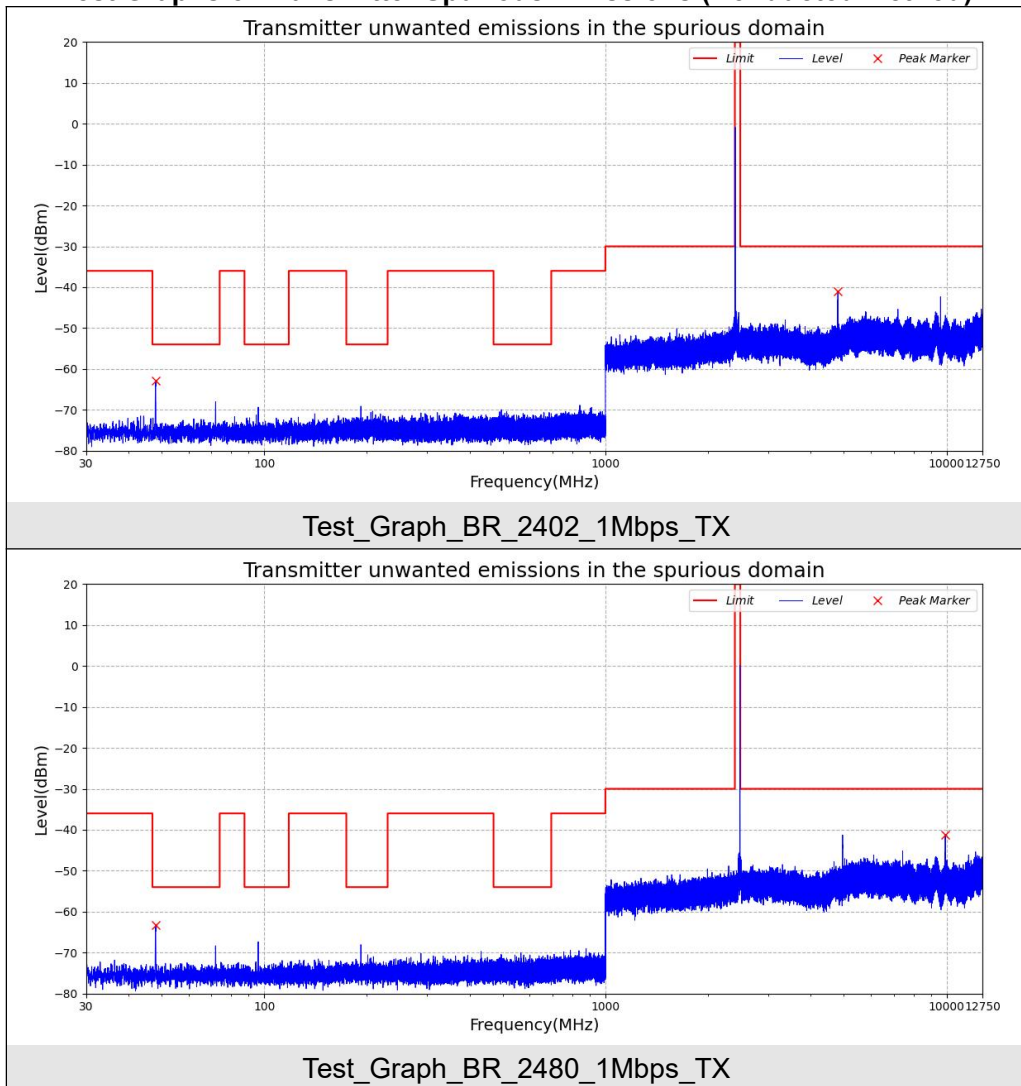

Any report having not been signed by authorized approver, or having been altered without authorization, or having not been stamped by the "Dedicated Testing/Inspection Stamp" is deemed to be invalid. Copying or excerpting portion of, or altering the content of the report is not permitted without the written authorization of AGC. The test results presented in the report apply only to the tested sample. Any objections to report issued by AGC should be submitted to AGC within 15days after the issuance of the test report. Further enquiry of validity or verification of the test report should be addressed to AGC by agc01@agccert.com.

Radiated Method:

(Worst Case: Low channel)

Transmitter Spurious Emission below 1GHz (30MHz-1GHz)

Frequency	Reading Level	Antenna	S.G.	Cable Loss	Ant.Gain	Emission Level	Limit	Margin
(MHz)	(dBuV/m)	Polarization	(dBm)	(dB)	(dBi)	(dBm)	(dBm)	(dB)
84.50	30.68	V	-61.82	0.48	0.54	-61.76	-36.00	25.76
130.56	30.84	V	-60.36	0.49	0.10	-60.75	-36.00	24.75
239.69	31.40	V	-67.10	0.52	6.60	-61.02	-36.00	25.02
325.90	30.79	V	-64.97	0.53	6.10	-59.40	-36.00	23.40
334.58	31.40	V	-63.54	0.53	5.94	-58.13	-36.00	22.13
827.35	31.53	V	-64.28	0.66	6.45	-58.49	-36.00	22.49
Other(30-1000)	--	V	--	--	--	--	-36.00/-54.00	--
83.92	32.22	H	-57.29	0.48	0.38	-57.39	-36.00	21.39
131.00	30.39	H	-61.65	0.49	0.10	-62.04	-36.00	26.04
242.31	29.87	H	-68.52	0.52	6.72	-62.32	-36.00	26.32
325.58	31.20	H	-64.80	0.53	6.10	-59.23	-36.00	23.23
735.49	31.38	H	-67.00	0.59	6.60	-60.99	-36.00	24.99
828.06	31.17	H	-67.18	0.66	6.40	-61.44	-36.00	25.44
Other(30-1000)	--	H	--	--	--	--	-36.00/-54.00	--

Any report having not been signed by authorized approver, or having been altered without authorization, or having not been stamped by the "Dedicated Testing/Inspection Stamp" is deemed to be invalid. Copying or excerpting portion of, or altering the content of the report is not permitted without the written authorization of AGC. The test results presented in the report apply only to the tested sample. Any objections to report issued by AGC should be submitted to AGC within 15days after the issuance of the test report. Further enquiry of validity or verification of the test report should be addressed to AGC by agc01@agccert.com.

Transmitter Spurious Emission above 1GHz (1GHz-12.75GHz)

Frequency	Reading Level	Antenna	S.G.	Cable Loss	Ant.Gain	Emission Level	Limit	Margin
(MHz)	(dBuV/m)	Polarization	(dBm)	(dB)	(dBi)	(dBm)	(dBm)	(dB)
4804	45.62	V	-48.25	2.64	9.30	-41.59	-30.00	11.59
7206	31.15	V	-57.28	3.11	11.45	-48.94	-30.00	18.94
--	--	V	--	--	--	--	--	--
--	--	V	--	--	--	--	--	--
--	--	V	--	--	--	--	--	--
Other(1000-12750)	--	V	--	--	--	--	-30.00	--
4804	41.37	H	-49.14	2.64	9.30	-42.47	-30.00	12.47
7206	31.06	H	-58.03	3.13	11.34	-49.82	-30.00	19.82
--	--	H	--	--	--	--	--	--
--	--	H	--	--	--	--	--	--
--	--	H	--	--	--	--	--	--
Other(1000-12750)	--	H	--	--	--	--	-30.00	--

Note: 1. The margins of the other spectrum are not exceeding the minimum value of margin, and this part of the results without recording in the test report.

2. Measurements above show only up to 6 maximum emissions noted, or would be lesser, with "--" remark, if no specific emission from the EUT are recorded (ie: margin>20dB from the applicable limit) and considered that's already beyond the background noise floor.

Any report having not been signed by authorized approver, or having been altered without authorization, or having not been stamped by the "Dedicated Testing/Inspection Stamp" is deemed to be invalid. Copying or excerpting portion of, or altering the content of the report is not permitted without the written authorization of AGC. The test results presented in the report apply only to the tested sample. Any objections to report issued by AGC should be submitted to AGC within 15days after the issuance of the test report. Further enquiry of validity or verification of the test report should be addressed to AGC by agc01@agccert.com.

(Worst Case: High channel)

Transmitter Spurious Emission below 1GHz (30MHz-1GHz)

Frequency	Reading Level	Antenna	S.G.	Cable Loss	Ant.Gain	Emission Level	Limit	Margin
(MHz)	(dBuV/m)	Polarization	(dBm)	(dB)	(dBi)	(dBm)	(dBm)	(dB)
84.52	30.76	V	-62.35	0.48	0.54	-62.29	-36.00	26.29
129.87	30.49	V	-59.88	0.49	0.14	-60.23	-36.00	24.23
240.46	31.62	V	-65.21	0.52	6.60	-59.13	-36.00	23.13
326.01	30.06	V	-67.82	0.53	6.10	-62.25	-36.00	26.25
334.39	31.24	V	-64.86	0.53	5.94	-59.45	-36.00	23.45
827.30	31.69	V	-65.77	0.66	6.45	-59.98	-36.00	23.98
Other(30-1000)	--	V	--	--	--	--	-36.00/-54.00	--
83.28	31.59	H	-59.46	0.48	0.38	-59.56	-36.00	23.56
131.82	30.74	H	-60.03	0.49	0.08	-60.44	-36.00	24.44
242.82	29.53	H	-66.46	0.52	6.72	-60.26	-36.00	24.26
325.88	30.66	H	-65.20	0.53	6.10	-59.63	-36.00	23.63
735.54	30.93	H	-64.45	0.59	6.60	-58.44	-36.00	22.44
827.40	31.13	H	-66.47	0.66	6.45	-60.68	-36.00	24.68
Other(30-1000)	--	H	--	--	--	--	-36.00/-54.00	--

Any report having not been signed by authorized approver, or having been altered without authorization, or having not been stamped by the "Dedicated Testing/Inspection Stamp" is deemed to be invalid. Copying or excerpting portion of, or altering the content of the report is not permitted without the written authorization of AGC. The test results presented in the report apply only to the tested sample. Any objections to report issued by AGC should be submitted to AGC within 15days after the issuance of the test report. Further enquiry of validity or verification of the test report should be addressed to AGC by agc01@agccert.com.

Transmitter Spurious Emission above 1GHz (1GHz-12.75GHz)

Frequency	Reading Level	Antenna	S.G.	Cable Loss	Ant.Gain	Emission Level	Limit	Margin
(MHz)	(dBuV/m)	Polarization	(dBm)	(dB)	(dBi)	(dBm)	(dBm)	(dB)
4960	45.58	V	-48.82	2.64	9.30	-42.16	-30.00	12.16
7440	31.42	V	-66.90	3.09	11.59	-58.40	-30.00	28.40
--	--	V	--	--	--	--	--	--
--	--	V	--	--	--	--	--	--
--	--	V	--	--	--	--	--	--
Other(1000-12750)	--	V	--	--	--	--	-30.00	--
4960	41.75	H	-48.64	2.64	9.30	-41.98	-30.00	11.98
7440	41.30	H	-57.23	3.11	11.46	-48.88	-30.00	18.88
--	--	H	--	--	--	--	--	--
--	--	H	--	--	--	--	--	--
--	--	H	--	--	--	--	--	--
Other(1000-12750)	--	H	--	--	--	--	-30.00	--

Note: 1. The margins of the other spectrum are not exceeding the minimum value of margin, and this part of the results without recording in the test report.

2. Measurements above show only up to 6 maximum emissions noted, or would be lesser, with "--" remark, if no specific emission from the EUT are recorded (ie: margin>20dB from the applicable limit) and considered that's already beyond the background noise floor.

Any report having not been signed by authorized approver, or having been altered without authorization, or having not been stamped by the "Dedicated Testing/Inspection Stamp" is deemed to be invalid. Copying or excerpting portion of, or altering the content of the report is not permitted without the written authorization of AGC. The test results presented in the report apply only to the tested sample. Any objections to report issued by AGC should be submitted to AGC within 15days after the issuance of the test report. Further enquiry of validity or verification of the test report should be addressed to AGC by agc01@agccert.com.

5.7. RECEIVER SPURIOUS EMISSIONS

5.7.1 LIMIT

Receiver spurious emissions are emissions at any frequency when the equipment is in receive mode. The spurious emissions of the receiver shall not exceed the values given in table.

Frequency Range	Maximum Power e.r.p(<=1GHz)/e.i.r.p(>1GHz)	Measurement Bandwidth
30 MHz to 1000 MHz	-57dBm	100kHz
1 GHz to 12.75 GHz	-47dBm	1MHz

5.7.2 TEST PROCEDURE

1)The emissions over the range 30 MHz to 1 000 MHz shall be identified.

2)Spectrum analyzer settings:

Resolution bandwidth: 100 kHz

Video bandwidth: 300 kHz

Detector mode: Peak

Sweep Points: $\geq 19\ 400$

Trace Mode: Max Hold

3)Allow the trace to stabilize. Any emissions identified during the sweeps above and that fall within the 6 dB range below the applicable limit or above, shall be individually measured using RMS detector and compared to the limits given in 5.7.1.

4) The emissions over the range 1 GHz to 12.75 GHz shall be identified.

5) Resolution bandwidth: 1 MHz

Video bandwidth: 3 MHz

Detector mode: Peak

Trace Mode: Max Hold

Sweep Points: ≥ 23200

6) Allow the trace to stabilize. Any emissions identified during the sweeps above and that fall within the 6 dB range below the applicable limit or above, shall be individually measured using RMS detector and compared to the limits given in 5.7.1.

7) For radiated method, the applicable measurement procedures as described in the EN 300 328 V2.2.2 annex C.2 and C.4 are used.

5.7.3 TEST CONFIGURATION

Refer to 5.6.3

5.7.4 TEST RESULT

Test Data of Receiver Spurious Emissions (Conducted Method)					
Test Mode	Detector	Frequency [MHz]	Level [dBm]	Limit [dBm]	Verdict
RX_2402_1Mbps	Peak	47.978	-65.36	-57.00	Pass
	Peak	2464.882	-58.75	-47.00	Pass
RX_2480_1Mbps	Peak	47.978	-64.93	-57.00	Pass
	Peak	2426.498	-56.23	-47.00	Pass

Test Graphs of Receiver Spurious Emissions (Conducted Method)

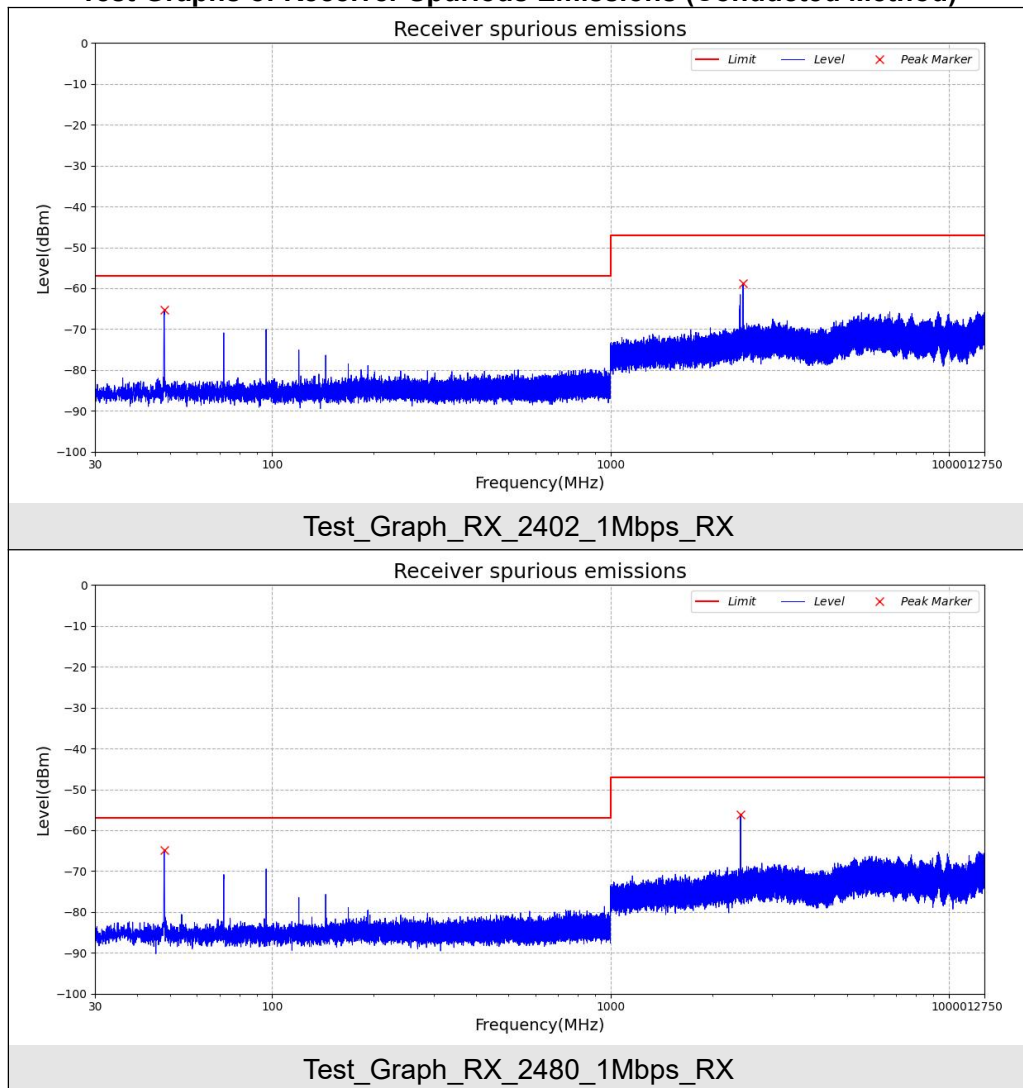

Any report having not been signed by authorized approver, or having been altered without authorization, or having not been stamped by the "Dedicated Testing/Inspection Stamp" is deemed to be invalid. Copying or excerpting portion of, or altering the content of the report is not permitted without the written authorization of AGC. The test results presented in the report apply only to the tested sample. Any objections to report issued by AGC should be submitted to AGC within 15days after the issuance of the test report. Further enquiry of validity or verification of the test report should be addressed to AGC by agc01@agccert.com.

Radiated Method:

(Worst Case: Low channel)

Receiver Spurious Emission below 1GHz (30MHz-1GHz)

Frequency	Reading Level	Antenna	S.G.	Cable Loss	Ant.Gain	Emission Level	Limit	Margin
(MHz)	(dBuV/m)	Polarization	(dBm)	(dB)	(dBi)	(dBm)	(dBm)	(dB)
114.31	30.37	V	-72.58	0.48	1.40	-71.66	-57.00	14.66
177.16	32.12	V	-73.66	0.51	3.06	-71.11	-57.00	14.11
229.15	30.03	V	-77.69	0.52	6.84	-71.37	-57.00	14.37
495.90	30.37	V	-77.59	0.56	7.05	-71.10	-57.00	14.10
664.36	30.80	V	-77.14	0.59	6.98	-70.75	-57.00	13.75
880.23	30.38	V	-76.19	0.69	5.90	-70.98	-57.00	13.98
Other(30-1000)	--	V	--	--	--	--	-57.00	--
84.21	32.21	H	-71.49	0.48	0.54	-71.43	-57.00	14.43
110.29	30.85	H	-71.74	0.48	1.40	-70.82	-57.00	13.82
218.76	30.63	H	-77.50	0.52	7.46	-70.56	-57.00	13.56
485.21	30.92	H	-77.34	0.56	7.00	-70.90	-57.00	13.90
554.39	30.87	H	-80.28	0.57	6.78	-74.07	-57.00	17.07
635.15	30.82	H	-78.66	0.58	7.20	-72.04	-57.00	15.04
Other(30-1000)	--	H	--	--	--	--	-57.00	--

Any report having not been signed by authorized approver, or having been altered without authorization, or having not been stamped by the "Dedicated Testing/Inspection Stamp" is deemed to be invalid. Copying or excerpting portion of, or altering the content of the report is not permitted without the written authorization of AGC. The test results presented in the report apply only to the tested sample. Any objections to report issued by AGC should be submitted to AGC within 15days after the issuance of the test report. Further enquiry of validity or verification of the test report should be addressed to AGC by agc01@agccert.com.

Receiver Spurious Emission above 1GHz (1GHz-12.75GHz)

Frequency	Reading Level	Antenna	S.G.	Cable Loss	Ant.Gain	Emission Level	Limit	Margin
(MHz)	(dBuV/m)	Polarization	(dBm)	(dB)	(dBi)	(dBm)	(dBm)	(dB)
4947.96	28.53	V	-71.15	2.74	9.58	-64.31	-47.00	17.31
--	--	V	--	--	--	--	--	--
--	--	V	--	--	--	--	--	--
--	--	V	--	--	--	--	--	--
--	--	V	--	--	--	--	--	--
Other(1000-12750)	--	V	--	--	--	--	-47.00	--
4952.89	29.70	H	-66.65	2.74	9.60	-59.80	-47.00	12.80
--	--	H	--	--	--	--	--	--
--	--	H	--	--	--	--	--	--
--	--	H	--	--	--	--	--	--
--	--	H	--	--	--	--	--	--
Other(1000-12750)	--	H	--	--	--	--	-47.00	--

Note: 1. The margins of the other spectrum are not exceeding the minimum value of margin, and this part of the results without recording in the test report.

2. Measurements above show only up to 6 maximum emissions noted, or would be lesser, with "--" remark, if no specific emission from the EUT are recorded (ie: margin>20dB from the applicable limit) and considered that's already beyond the background noise floor.

Any report having not been signed by authorized approver, or having been altered without authorization, or having not been stamped by the "Dedicated Testing/Inspection Stamp" is deemed to be invalid. Copying or excerpting portion of, or altering the content of the report is not permitted without the written authorization of AGC. The test results presented in the report apply only to the tested sample. Any objections to report issued by AGC should be submitted to AGC within 15days after the issuance of the test report. Further enquiry of validity or verification of the test report should be addressed to AGC by agc01@agccert.com.

(Worst Case: High channel)

Receiver Spurious Emission below 1GHz (30MHz-1GHz)

Frequency	Reading Level	Antenna	S.G.	Cable Loss	Ant.Gain	Emission Level	Limit	Margin
(MHz)	(dBuV/m)	Polarization	(dBm)	(dB)	(dBi)	(dBm)	(dBm)	(dB)
114.89	30.46	V	-72.20	0.48	1.40	-71.28	-57.00	14.28
176.92	31.98	V	-73.00	0.51	2.88	-70.63	-57.00	13.63
228.95	29.67	V	-77.67	0.52	7.08	-71.11	-57.00	14.11
496.23	30.63	V	-76.98	0.56	7.04	-70.50	-57.00	13.50
664.30	30.53	V	-77.41	0.59	6.98	-71.02	-57.00	14.02
879.56	31.15	V	-76.17	0.69	5.87	-70.99	-57.00	13.99
Other(30-1000)	--	V	--	--	--	--	-57.00	--
84.07	32.05	H	-70.96	0.48	0.54	-70.90	-57.00	13.90
110.06	30.58	H	-72.37	0.48	1.40	-71.45	-57.00	14.45
218.84	31.19	H	-77.33	0.52	7.46	-70.39	-57.00	13.39
484.63	30.88	H	-77.07	0.56	6.98	-70.65	-57.00	13.65
554.54	31.23	H	-80.03	0.57	6.78	-73.82	-57.00	16.82
635.41	31.02	H	-78.75	0.58	7.20	-72.13	-57.00	15.13
Other(30-1000)	--	H	--	--	--	--	-57.00	--

Any report having not been signed by authorized approver, or having been altered without authorization, or having not been stamped by the "Dedicated Testing/Inspection Stamp" is deemed to be invalid. Copying or excerpting portion of, or altering the content of the report is not permitted without the written authorization of AGC. The test results presented in the report apply only to the tested sample. Any objections to report issued by AGC should be submitted to AGC within 15days after the issuance of the test report. Further enquiry of validity or verification of the test report should be addressed to AGC by agc01@agccert.com.

Receiver Spurious Emission above 1GHz (1GHz-12.75GHz)

Frequency	Reading Level	Antenna	S.G.	Cable Loss	Ant.Gain	Emission Level	Limit	Margin
(MHz)	(dBuV/m)	Polarization	(dBm)	(dB)	(dBi)	(dBm)	(dBm)	(dB)
4948.03	28.53	V	-68.20	2.74	9.58	-61.36	-47.00	14.36
--	--	V	--	--	--	--	--	--
--	--	V	--	--	--	--	--	--
--	--	V	--	--	--	--	--	--
--	--	V	--	--	--	--	--	--
Other(1000-12750)	--	V	--	--	--	--	-47.00	--
4952.92	30.12	H	-67.87	2.74	9.60	-61.01	-47.00	14.01
--	--	H	--	--	--	--	--	--
--	--	H	--	--	--	--	--	--
--	--	H	--	--	--	--	--	--
--	--	H	--	--	--	--	--	--
Other(1000-12750)	--	H	--	--	--	--	-47.00	--

Note: 1. The margins of the other spectrum are not exceeding the minimum value of margin, and this part of the results without recording in the test report.

2. Measurements above show only up to 6 maximum emissions noted, or would be lesser, with "--" remark, if no specific emission from the EUT are recorded (ie: margin>20dB from the applicable limit) and considered that's already beyond the background noise floor.

Any report having not been signed by authorized approver, or having been altered without authorization, or having not been stamped by the "Dedicated Testing/Inspection Stamp" is deemed to be invalid. Copying or excerpting portion of, or altering the content of the report is not permitted without the written authorization of AGC. The test results presented in the report apply only to the tested sample. Any objections to report issued by AGC should be submitted to AGC within 15days after the issuance of the test report. Further enquiry of validity or verification of the test report should be addressed to AGC by agc01@agccert.com.

5.8. RECEIVER BLOCKING

5.8.1 LIMIT

Receiver Blocking parameters for Receiver Category 1 equipment

Wanted signal mean power from companion device (dBm) (see notes 1 and 4)	Blocking signal frequency (MHz)	Blocking signal power (dBm) (see note 4)	Type of blocking signal
(-133 dBm + 10 × log ₁₀ (OCBW)) or -68 dBm whichever is less (see note 2)	2 380	-34	CW
	2 504		
(-139 dBm + 10 × log ₁₀ (OCBW)) or -74 dBm whichever is less (see note 3)	2 300		
	2 330		
	2 360		
	2 524		
	2 584		
	2 674		

NOTE 1: OCBW is in Hz.

NOTE 2: In case of radiated measurements using a companion device and the level of the wanted signal from the companion device cannot be determined, a relative test may be performed using a wanted signal up to $P_{min} + 26$ dB where P_{min} is the minimum level of wanted signal required to meet the minimum performance criteria as defined in clause 4.3.1.12.3 in the absence of any blocking signal.

NOTE 3: In case of radiated measurements using a companion device and the level of the wanted signal from the companion device cannot be determined, a relative test may be performed using a wanted signal up to $P_{min} + 20$ dB where P_{min} is the minimum level of wanted signal required to meet the minimum performance criteria as defined in clause 4.3.1.12.3 in the absence of any blocking signal.

NOTE 4: The level specified is the level at the UUT receiver input assuming a 0 dBi antenna assembly gain. In case of conducted measurements, this level has to be corrected for the (in-band) antenna assembly gain (G). In case of radiated measurements, this level is equivalent to a power flux density (PFD) in front of the UUT antenna with the UUT being configured/positioned as recorded in clause 5.4.3.2.2.

Receiver Blocking parameters for Receiver Category 2 equipment

Wanted signal mean power from companion device (dBm) (see notes 1 and 3)	Blocking signal frequency (MHz)	Blocking signal power (dBm) (see note 3)	Type of blocking signal
(-139 dBm + 10 × log ₁₀ (OCBW) + 10 dB) or (-74 dBm + 10 dB) whichever is less (see note 2)	2 380	-34	CW
	2 504		
	2 300		
	2 584		

NOTE 1: OCBW is in Hz.

NOTE 2: In case of radiated measurements using a companion device and the level of the wanted signal from the companion device cannot be determined, a relative test may be performed using a wanted signal up to P_{min} + 26 dB where P_{min} is the minimum level of wanted signal required to meet the minimum performance criteria as defined in clause 4.3.1.12.3 in the absence of any blocking signal.

NOTE 3: The level specified is the level at the UUT receiver input assuming a 0 dBi antenna assembly gain. In case of conducted measurements, this level has to be corrected for the (in-band) antenna assembly gain (G). In case of radiated measurements, this level is equivalent to a power flux density (PFD) in front of the UUT antenna with the UUT being configured/positioned as recorded in clause 5.4.3.2.2.

Receiver Blocking parameters for Receiver Category 3 equipment

Wanted signal mean power from companion device (dBm) (see notes 1 and 3)	Blocking signal frequency (MHz)	Blocking signal power (dBm) (see note 3)	Type of blocking signal
(-139 dBm + 10 × log ₁₀ (OCBW) + 20 dB) or (-74 dBm + 20 dB) whichever is less (see note 2)	2 380	-34	CW
	2 504		
	2 300		
	2 584		

NOTE 1: OCBW is in Hz.

NOTE 2: In case of radiated measurements using a companion device and the level of the wanted signal from the companion device cannot be determined, a relative test may be performed using a wanted signal up to P_{min} + 30 dB where P_{min} is the minimum level of wanted signal required to meet the minimum performance criteria as defined in clause 4.3.1.12.3 in the absence of any blocking signal.

NOTE 3: The level specified is the level at the UUT receiver input assuming a 0 dBi antenna assembly gain. In case of conducted measurements, this level has to be corrected for the (in-band) antenna assembly gain (G). In case of radiated measurements, this level is equivalent to a power flux density (PFD) in front of the UUT antenna with the UUT being configured/positioned as recorded in clause 5.4.3.2.2.

5.8.2 TEST PROCEDURE

For non-FHSS equipment, having more than one operating channel, the operating channels on which the testing has to be performed shall be selected as follows:

- For testing blocking frequencies less than 2 400 MHz, the equipment shall operate on the lowest operating channel.
- For testing blocking frequencies greater than 2 500 MHz, the equipment shall operate on the highest operating channel.

The simplified conducted measure procedures are as follows:

- 1) For non-FHSS equipment, the UUT shall be set to the lowest operating channel on which the blocking test has to be performed.
- 2) The blocking signal generator is set to the first frequency as defined in the appropriate table corresponding to the receiver category and type of equipment.
- 3) With the blocking signal generator switched off, a communication link is established between the UUT and the associated companion device using the test setup. The level of the wanted signal shall be set to the value provided in the table corresponding to the receiver category and type of equipment. This level may be measured directly at the output of the companion device and a correction is made for the coupling loss into the UUT. The actual level for the wanted signal shall be recorded in the test report.
- 4) The blocking signal at the UUT is set to the level provided in the table corresponding to the receiver category and type of equipment. It shall be verified and recorded in the test report that the performance criteria is met.
- 5) Repeat step 4 for each remaining combination of frequency and level for the blocking signal as provided in the table corresponding to the receiver category and type of equipment.
- 6) Repeat step 2 to step 5 with the UUT operating at the highest operating channel.

Any report having not been signed by authorized approver, or having been altered without authorization, or having not been stamped by the "Dedicated Testing/Inspection Stamp" is deemed to be invalid. Copying or excerpting portion of, or altering the content of the report is not permitted without the written authorization of AGC. The test results presented in the report apply only to the tested sample. Any objections to report issued by AGC should be submitted to AGC within 15days after the issuance of the test report. Further enquiry of validity or verification of the test report should be addressed to AGC by agc01@agccert.com.

5.8.3 TEST CONFIGURATION

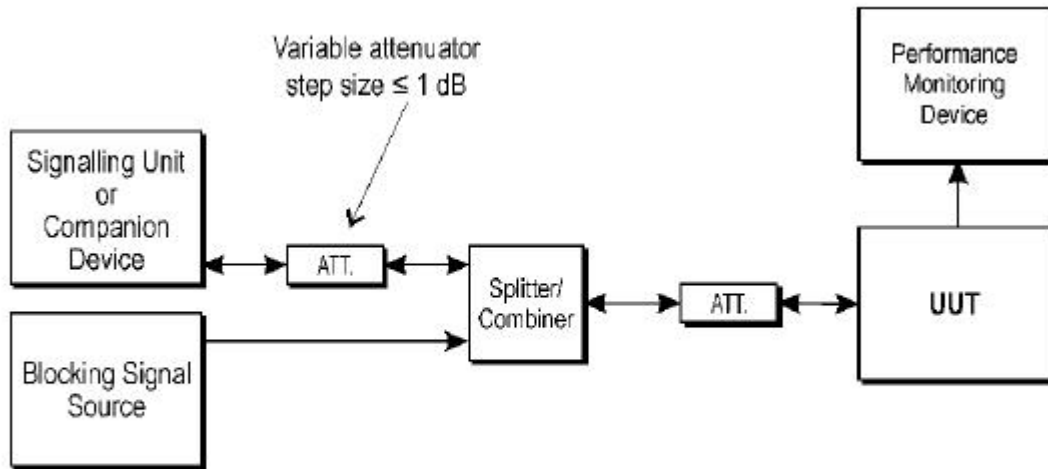

Test Set-up for receiver blocking

Any report having not been signed by authorized approver, or having been altered without authorization, or having not been stamped by the “Dedicated Testing/Inspection Stamp” is deemed to be invalid. Copying or excerpting portion of, or altering the content of the report is not permitted without the written authorization of AGC. The test results presented in the report apply only to the tested sample. Any objections to report issued by AGC should be submitted to AGC within 15days after the issuance of the test report. Further enquiry of validity or verification of the test report should be addressed to AGC by agc01@agccert.com.

5.8.4 TEST RESULTS

Test Condition	Blocking Signal Frequency(MHz)	Blocking Signal Power(dBm)	Wanted signal mean power from companion device(dBm)	Performance PER	Limit PER	Result
GFSK Hopping Mode	2 300	-34.58	-59.66	1.10%	10%	Pass
	2 380	-34.58	-59.66	0.79%	10%	
	2 504	-34.58	-59.60	1.86%	10%	
	2 584	-34.58	-59.60	0.72%	10%	

Test Condition	Blocking Signal Frequency(MHz)	Blocking Signal Power(dBm)	Wanted signal mean power from companion device(dBm)	Performance PER	Limit PER	Result
π /4-DQPSK Hopping Mode	2 300	-34.58	-58.68	1.29%	10%	Pass
	2 380	-34.58	-58.68	0.84%	10%	
	2 504	-34.58	-58.60	1.82%	10%	
	2 584	-34.58	-58.60	1.00%	10%	

Test Condition	Blocking Signal Frequency(MHz)	Blocking Signal Power(dBm)	Wanted signal mean power from companion device(dBm)	Performance PER	Limit PER	Result
8-DPSK Hopping Mode	2 300	-34.58	-58.66	1.15%	10%	Pass
	2 380	-34.58	-58.66	0.91%	10%	
	2 504	-34.58	-58.64	1.58%	10%	
	2 584	-34.58	-58.64	0.99%	10%	

Note: The levels of the blocking signal and wanted signal have to be corrected for the (in-band) antenna assembly gain.

Any report having not been signed by authorized approver, or having been altered without authorization, or having not been stamped by the "Dedicated Testing/Inspection Stamp" is deemed to be invalid. Copying or excerpting portion of, or altering the content of the report is not permitted without the written authorization of AGC. The test results presented in the report apply only to the tested sample. Any objections to report issued by AGC should be submitted to AGC within 15days after the issuance of the test report. Further enquiry of validity or verification of the test report should be addressed to AGC by agc01@agccert.com.

APPENDIX A: PHOTOGRAPHS OF THE TEST SETUP

RF CONDUCTED TEST SETUP

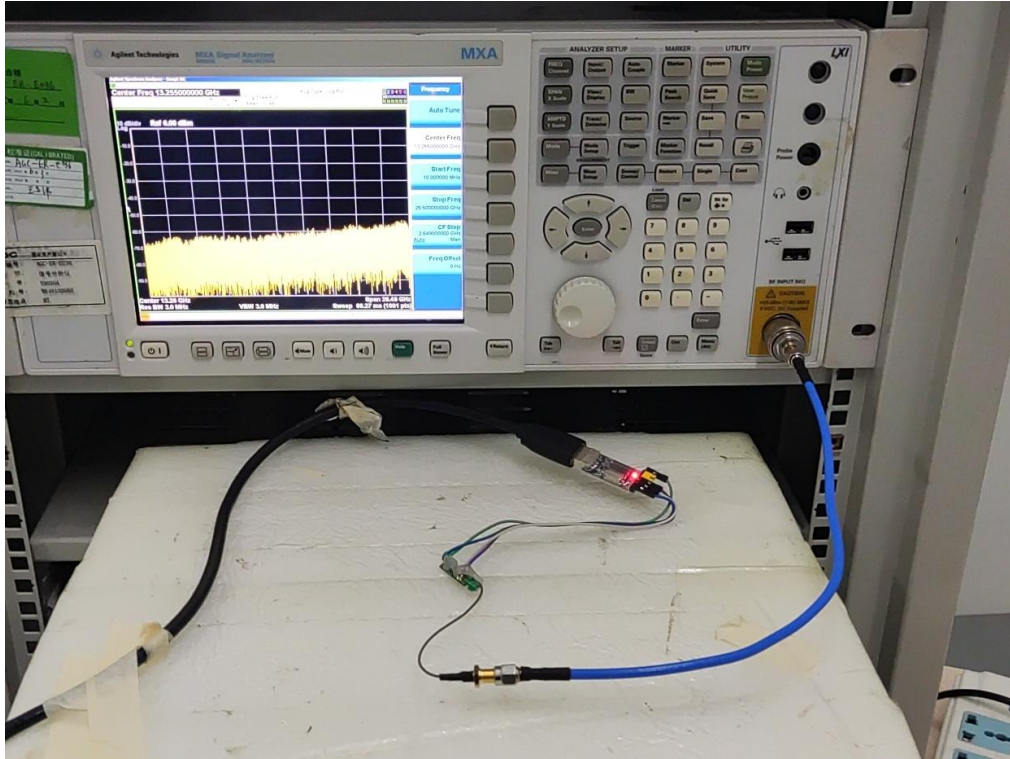

RADIATED SPURIOUS EMISSION TEST SETUP

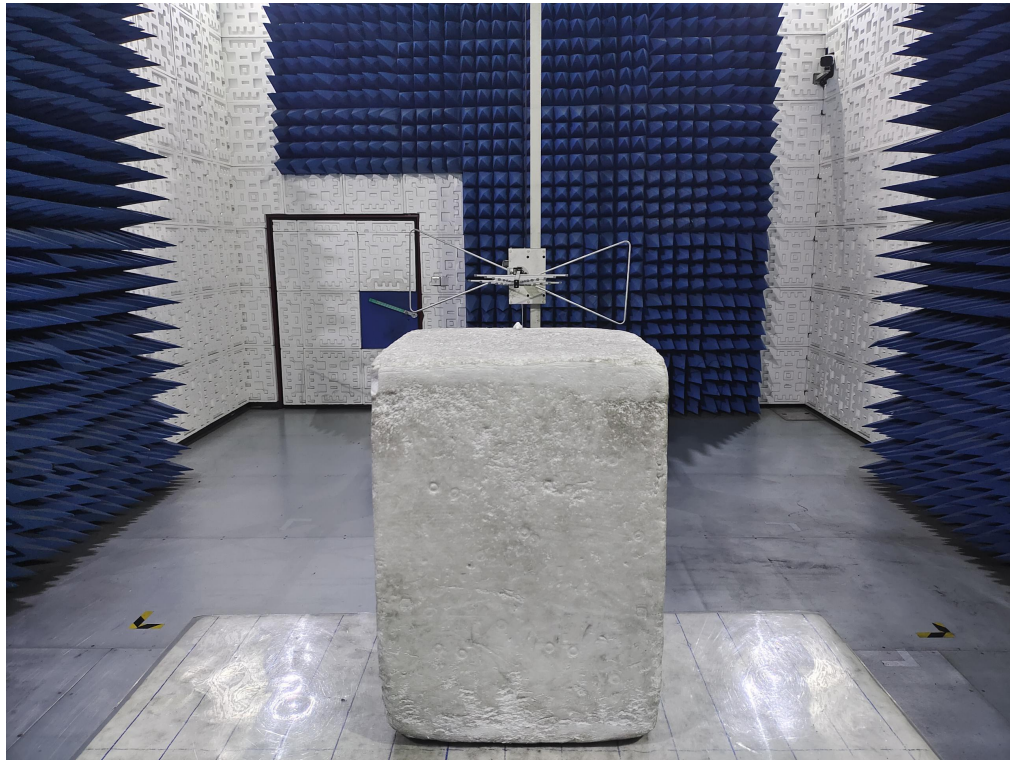

Any report having not been signed by authorized approver, or having been altered without authorization, or having not been stamped by the “Dedicated Testing/Inspection Stamp” is deemed to be invalid. Copying or excerpting portion of, or altering the content of the report is not permitted without the written authorization of AGC. The test results presented in the report apply only to the tested sample. Any objections to report issued by AGC should be submitted to AGC within 15days after the issuance of the test report. Further enquiry of validity or verification of the test report should be addressed to AGC by agc01@agccert.com.

RADIATED SPURIOUS EMISSION ABOVE 1G TEST SETUP**APPENDIX B: PHOTOGRAPHS OF EUT**

Refer to the Report No.: AGC05443230405AP01

----END OF REPORT----

Any report having not been signed by authorized approver, or having been altered without authorization, or having not been stamped by the "Dedicated Testing/Inspection Stamp" is deemed to be invalid. Copying or excerpting portion of, or altering the content of the report is not permitted without the written authorization of AGC. The test results presented in the report apply only to the tested sample. Any objections to report issued by AGC should be submitted to AGC within 15days after the issuance of the test report. Further enquiry of validity or verification of the test report should be addressed to AGC by agc01@agccert.com.

Attestation of Global Compliance(Shenzhen)Co., Ltd
Attestation of Global Compliance(Shenzhen)Std & Tech Co., Ltd
Tel: +86-755 2523 4088 E-mail: agc@agccert.com Web: <http://www.agccert.com/>



Conditions of Issuance of Test Reports

1. All samples and goods are accepted by the Attestation of Global Compliance (Shenzhen) Co., Ltd (the “Company”) solely for testing and reporting in accordance with the following terms and conditions. The company provides its services on the basis that such terms and conditions constitute express agreement between the company and any person, firm or company requesting its services (the “Clients”).
2. Any report issued by Company as a result of this application for testing services (the “Report”) shall be issued in confidence to the Clients and the Report will be strictly treated as such by the Company. It may not be reproduced either in its entirety or in part and it may not be used for advertising or other unauthorized purposes without the written consent of the Company. The Clients to whom the Report is issued may, however, show or send it, or a certified copy thereof prepared by the Company to its customer, supplier or other persons directly concerned. The Company will not, without the consent of the Clients, enter into any discussion or correspondence with any third party concerning the contents of the Report, unless required by the relevant governmental authorities, laws or court orders.
3. The Company shall not be called or be liable to be called to give evidence or testimony on the Report in a court of law without its prior written consent, unless required by the relevant governmental authorities, laws or court orders.
4. In the event of the improper use of the report as determined by the Company, the Company reserves the right to withdraw it, and to adopt any other additional remedies which may be appropriate.
5. Samples submitted for testing are accepted on the understanding that the Report issued cannot form the basis of, or be the instrument for, any legal action against the Company.
6. The Company will not be liable for or accept responsibility for any loss or damage however arising from the use of information contained in any of its Reports or in any communication whatsoever about its said tests or investigations.
7. Clients wishing to use the Report in court proceedings or arbitration shall inform the Company to that effect prior to submitting the sample for testing.
8. The Company is not responsible for recalling the electronic version of the original report when any revision is made to them. The Client assumes the responsibility to providing the revised version to any interested party who uses them.
9. Subject to the variable length of retention time for test data and report stored hereinto as otherwise specifically required by individual accreditation authorities, the Company will only keep the supporting test data and information of the test report for a period of six years. The data and information will be disposed of after the aforementioned retention period has elapsed. Under no circumstances shall we provide any data and information which has been disposed of after retention period. Under no circumstances shall we be liable for damage of any kind, including (but not limited to) compensatory damages, lost profits, lost data, or any form of special, incidental, indirect, consequential or punitive damages of any kind, whether based on breach of contract of warranty, tort (including negligence), product liability or otherwise, even if we are informed in advance of the possibility of such damages.

Any report having not been signed by authorized approver, or having been altered without authorization, or having not been stamped by the “Dedicated Testing/Inspection Stamp” is deemed to be invalid. Copying or excerpting portion of, or altering the content of the report is not permitted without the written authorization of AGC. The test results presented in the report apply only to the tested sample. Any objections to report issued by AGC should be submitted to AGC within 15days after the issuance of the test report. Further enquiry of validity or verification of the test report should be addressed to AGC by agc01@agccert.com.

Health Test Report

Report No.: AGC05443230405EH02

PRODUCT DESIGNATION : TWS earbuds with charging base
BRAND NAME : N/A
MODEL NAME : MO6128, MO6780
APPLICANT : MID OCEAN BRANDS B.V
DATE OF ISSUE : Jul. 03, 2023
STANDARD(S) : EN 62479:2010
: EN 50663:2017
REPORT VERSION : V1.0

Attestation of Global Compliance (Shenzhen) Co., Ltd



Any report having not been signed by authorized approver, or having been altered without authorization, or having not been stamped by the "Dedicated Testing/Inspection Stamp" is deemed to be invalid. Copying or excerpting portion of, or altering the content of the report is not permitted without the written authorization of AGC. The test results presented in the report apply only to the tested sample. Any objections to report issued by AGC should be submitted to AGC within 15days after the issuance of the test report. Further enquiry of validity or verification of the test report should be addressed to AGC by agc01@agccert.com.

Attestation of Global Compliance(Shenzhen)Co., Ltd
Attestation of Global Compliance(Shenzhen)Std & Tech Co., Ltd
Tel: +86-755 2523 4088 E-mail: agc@agccert.com Web: <http://www.agccert.com/>



REPORT REVISE RECORD

Report Version	Revise Time	Issued Date	Valid Version	Notes
V1.0	/	Jul. 03, 2023	Valid	Initial release

Any report having not been signed by authorized approver, or having been altered without authorization, or having not been stamped by the "Dedicated Testing/Inspection Stamp" is deemed to be invalid. Copying or excerpting portion of, or altering the content of the report is not permitted without the written authorization of AGC. The test results presented in the report apply only to the tested sample. Any objections to report issued by AGC should be submitted to AGC within 15days after the issuance of the test report. Further enquiry of validity or verification of the test report should be addressed to AGC by agc01@agccert.com.

TABLE OF CONTENTS

1. GENERAL INFORMATION	4
2. TECHNICAL INFORMATION	5
3. TEST RESULT	6
4. CONCLUSION	6

Any report having not been signed by authorized approver, or having been altered without authorization, or having not been stamped by the "Dedicated Testing/Inspection Stamp" is deemed to be invalid. Copying or excerpting portion of, or altering the content of the report is not permitted without the written authorization of AGC. The test results presented in the report apply only to the tested sample. Any objections to report issued by AGC should be submitted to AGC within 15days after the issuance of the test report. Further enquiry of validity or verification of the test report should be addressed to AGC by agc01@agccert.com.

Attestation of Global Compliance(Shenzhen)Co., Ltd
Attestation of Global Compliance(Shenzhen)Std & Tech Co., Ltd
Tel: +86-755 2523 4088 E-mail: agc@agccert.com Web: <http://www.agccert.com/>

1. GENERAL INFORMATION

Applicant	MID OCEAN BRANDS B.V
Address	7/F, Kings Tower, 111 King Lam Street, Cheung Sha Wan, Kowloon, Hong Kong.
Manufacturer	MID OCEAN BRANDS B.V
Address	7/F, Kings Tower, 111 King Lam Street, Cheung Sha Wan, Kowloon, Hong Kong.
Factory	MID OCEAN BRANDS B.V
Address	7/F, Kings Tower, 111 King Lam Street, Cheung Sha Wan, Kowloon, Hong Kong.
Product Designation	TWS earbuds with charging base
Brand Name	N/A
Test Model	MO6128
Series Model	MO6780
Declaration Difference	All the same except for the model name and shell.
Date of receipt of test item	Jun. 19, 2023
Date of test	Jun. 19, 2023 to Jul. 03, 2023
Test Result	Pass

We (AGC), Attestation of Global Compliance (Shenzhen) Co., Ltd. for compliance with the requirements set forth in the European Standard EN 62479:2010. The results of testing in this report apply to the product/system which was tested only.

Prepared By



Cici Ci
(Project Engineer) Jul. 03, 2023

Reviewed By



Calvin Liu
(Reviewer) Jul. 03, 2023

Approved By



Max Zhang
(Authorized Officer) Jul. 03, 2023

Any report having not been signed by authorized approver, or having been altered without authorization, or having not been stamped by the “Dedicated Testing/Inspection Stamp” is deemed to be invalid. Copying or excerpting portion of, or altering the content of the report is not permitted without the written authorization of AGC. The test results presented in the report apply only to the tested sample. Any objections to report issued by AGC should be submitted to AGC within 15days after the issuance of the test report. Further enquiry of validity or verification of the test report should be addressed to AGC by agc01@agccert.com.

2. TECHNICAL INFORMATION

The following data is based on the information by the applicant.

Product Designation	TWS earbuds with charging base
Brand Name	N/A
Test Model	MO6128
Hardware Version	V1
Software Version	V1
Operating Frequency	2.402 GHz to 2.480GHz
Bluetooth Version	V5.0
Modulation type	BR <input checked="" type="checkbox"/> GFSK_1Mbps ; EDR <input checked="" type="checkbox"/> π /4-DQPSK_2Mbps <input checked="" type="checkbox"/> 8DPSK_3Mbps BLE <input type="checkbox"/> GFSK 1Mbps <input type="checkbox"/> GFSK 2Mbps
Antenna Type	<input checked="" type="checkbox"/> Ceramic Antenna(Temporary RF connector provided by manufacturer) <input type="checkbox"/> Dedicated Antenna
Antenna gain	-0.58dBi
Power Supply (Headset)	DC 3.7V by battery
Power Supply (Charging dock)	DC 3.7V by battery or DC 5V by adapter

Note: For more details, please refer to the user's manual of the EUT.

Any report having not been signed by authorized approver, or having been altered without authorization, or having not been stamped by the "Dedicated Testing/Inspection Stamp" is deemed to be invalid. Copying or excerpting portion of, or altering the content of the report is not permitted without the written authorization of AGC. The test results presented in the report apply only to the tested sample. Any objections to report issued by AGC should be submitted to AGC within 15days after the issuance of the test report. Further enquiry of validity or verification of the test report should be addressed to AGC by agc01@agccert.com.

Attestation of Global Compliance(Shenzhen)Co., Ltd
Attestation of Global Compliance(Shenzhen)Std & Tech Co., Ltd
Tel: +86-755 2523 4088 E-mail: agc@agccert.com Web: http://www.agccert.com/

3. TEST RESULT

The maximum output power of Bluetooth is **-0.15dBm (0.97mW which is less than 20mW)**. Please refer to ETSI EN 300 328 (V2.2.2) Test report (AGC05443230405EE04) for the result of Maximum Transmit Power, which deemed to comply with the basic restrictions without testing.

4. CONCLUSION

Remark: EUT meets the basic requirements in the standard.

Any report having not been signed by authorized approver, or having been altered without authorization, or having not been stamped by the "Dedicated Testing/Inspection Stamp" is deemed to be invalid. Copying or excerpting portion of, or altering the content of the report is not permitted without the written authorization of AGC. The test results presented in the report apply only to the tested sample. Any objections to report issued by AGC should be submitted to AGC within 15days after the issuance of the test report. Further enquiry of validity or verification of the test report should be addressed to AGC by agc01@agccert.com.



Conditions of Issuance of Test Reports

1. All samples and goods are accepted by the Attestation of Global Compliance (Shenzhen) Co., Ltd (the “Company”) solely for testing and reporting in accordance with the following terms and conditions. The company provides its services on the basis that such terms and conditions constitute express agreement between the company and any person, firm or company requesting its services (the “Clients”).
2. Any report issued by Company as a result of this application for testing services (the “Report”) shall be issued in confidence to the Clients and the Report will be strictly treated as such by the Company. It may not be reproduced either in its entirety or in part and it may not be used for advertising or other unauthorized purposes without the written consent of the Company. The Clients to whom the Report is issued may, however, show or send it, or a certified copy thereof prepared by the Company to its customer, supplier or other persons directly concerned. The Company will not, without the consent of the Clients, enter into any discussion or correspondence with any third party concerning the contents of the Report, unless required by the relevant governmental authorities, laws or court orders.
3. The Company shall not be called or be liable to be called to give evidence or testimony on the Report in a court of law without its prior written consent, unless required by the relevant governmental authorities, laws or court orders.
4. In the event of the improper use of the report as determined by the Company, the Company reserves the right to withdraw it, and to adopt any other additional remedies which may be appropriate.
5. Samples submitted for testing are accepted on the understanding that the Report issued cannot form the basis of, or be the instrument for, any legal action against the Company.
6. The Company will not be liable for or accept responsibility for any loss or damage however arising from the use of information contained in any of its Reports or in any communication whatsoever about its said tests or investigations.
7. Clients wishing to use the Report in court proceedings or arbitration shall inform the Company to that effect prior to submitting the sample for testing.
8. The Company is not responsible for recalling the electronic version of the original report when any revision is made to them. The Client assumes the responsibility to providing the revised version to any interested party who uses them.
9. Subject to the variable length of retention time for test data and report stored hereinto as otherwise specifically required by individual accreditation authorities, the Company will only keep the supporting test data and information of the test report for a period of six years. The data and information will be disposed of after the aforementioned retention period has elapsed. Under no circumstances shall we provide any data and information which has been disposed of after retention period. Under no circumstances shall we be liable for damage of any kind, including (but not limited to) compensatory damages, lost profits, lost data, or any form of special, incidental, indirect, consequential or punitive damages of any kind, whether based on breach of contract of warranty, tort (including negligence), product liability or otherwise, even if we are informed in advance of the possibility of such damages.

Any report having not been signed by authorized approver, or having been altered without authorization, or having not been stamped by the “Dedicated Testing/Inspection Stamp” is deemed to be invalid. Copying or excerpting portion of, or altering the content of the report is not permitted without the written authorization of AGC. The test results presented in the report apply only to the tested sample. Any objections to report issued by AGC should be submitted to AGC within 15days after the issuance of the test report. Further enquiry of validity or verification of the test report should be addressed to AGC by agc01@agccert.com.