RF Test Report

Report No.: AGC05443220333EE04

PRODUCT DESIGNATION : Wireless charging earbuds
BRAND NAME : N/A
MODEL NAME : M09768
APPLICANT : MID OCEAN BRANDS B.V
DATE OF ISSUE : Apr. 14, 2022
STANDARD(S) : ETSI EN 300 328 V2.2.2 (2019-07)
REPORT VERSION : V1.0

Attestation of Global Compliance (Shenzhen) Co., Ltd



Any report having not been signed by authorized approver, or having been altered without authorization, or having not been stamped by the "Dedicated Testing/Inspection Stamp" is deemed to be invalid. Copying or excerpting portion of, or altering the content of the report is not permitted without the written authorization of AGC. The test results presented in the report apply only to the tested sample. Any objections to report issued by AGC should be submitted to AGC within 15days after the issuance of the test report. Further enquiry of validity or verification of the test report should be addressed to AGC by agc01@agccert.com.

REPORT REVISE RECORD

Report Version	Revise Time	Issued Date	Valid Version	Notes
V1.0	/	Apr. 14, 2022	Valid	Initial Release

Any report having not been signed by authorized approver, or having been altered without authorization, or having not been stamped by the "Dedicated Testing/Inspection Stamp" is deemed to be invalid. Copying or excerpting portion of, or altering the content of the report is not permitted without the written authorization of AGC. The test results presented in the report apply only to the tested sample. Any objections to report issued by AGC should be submitted to AGC within 15days after the issuance of the test report. Further enquiry of validity or verification of the test report should be addressed to AGC by agc01@agccert.com.

TABLE OF CONTENTS

1. VERIFICATION OF CONFORMITY	4
2. GENERAL INFORMATION	5
2.1. EUT DESCRIPTION	5
2.2. SUPPORT EQUIPMENT	6
2.3. DESCRIPTION OF TEST MODES.....	6
2.4. OBJECTIVE	7
2.5. TEST ITEMS AND THE RESULTS.....	7
2.6. ENVIRONMENTAL CONDITIONS	7
3. MEASUREMENT UNCERTAINTY	8
4. IDENTIFICATION OF THE RESPONSIBLE TESTING LOCATION	9
5. ETSI EN 300 328 REQUIREMENTS	10
5.1. RF OUTPUT POWER.....	10
5.2. ACCUMULATED TRANSMIT TIME, FREQUENCY OCCUPIATION AND HOPPING SEQUENCE	13
5.3. HOPPING FREQUENCY SEPARATION.....	20
5.4. OCCUPIED CHANNEL BANDWIDTH.....	22
5.5. TRANSMITTER UNWANTED EMISSIONS IN THE OUT OF BAND DOMAIN.....	26
5.6. TRANSMITTER SPURIOUS EMISSIONS	29
5.7. RECEIVER SPURIOUS EMISSIONS	38
5.8. RECEIVER BLOCKING.....	44
APPENDIX A: PHOTOGRAPHS OF THE TEST SETUP	48
APPENDIX B: PHOTOGRAPHS OF EUT	50

Any report having not been signed by authorized approver, or having been altered without authorization, or having not been stamped by the "Dedicated Testing/Inspection Stamp" is deemed to be invalid. Copying or excerpting portion of, or altering the content of the report is not permitted without the written authorization of AGC. The test results presented in the report apply only to the tested sample. Any objections to report issued by AGC should be submitted to AGC within 15days after the issuance of the test report. Further enquiry of validity or verification of the test report should be addressed to AGC by agc01@agccert.com.

1. VERIFICATION OF CONFORMITY

Applicant	MID OCEAN BRANDS B.V
Address	7/F, Kings Tower, 111 King Lam Street, Cheung Sha Wan, Kowloon, Hong Kong
Manufacturer	MID OCEAN BRANDS B.V
Address	7/F, Kings Tower, 111 King Lam Street, Cheung Sha Wan, Kowloon, Hong Kong
Factory	MID OCEAN BRANDS B.V
Address	7/F, Kings Tower, 111 King Lam Street, Cheung Sha Wan, Kowloon, Hong Kong
Product Designation	Wireless charging earbuds
Brand Name	N/A
Test Model	MO9768
Date of test	Mar. 31, 2022 to Apr. 12, 2022
Deviation	None
Condition of Test Sample	Normal
Test Result	Pass
Report Template	AGCRT-EC-BR/RF

We (AGC), Attestation of Global Compliance (Shenzhen) Co., Ltd. for compliance with the requirements set forth in the European Standard ETSI EN 300 328 V2.2.2. The results of test in this report apply to the product/system which was tested only. Other similar equipment will not necessarily produce the same results due to production tolerance and measurement uncertainties.

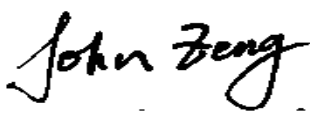
Prepared By 

 John Zeng
 (Project Engineer) Apr. 14, 2022

Reviewed By 

 Calvin Liu
 (Reviewer) Apr. 14, 2022

Approved By 

 Max Zhang
 (Authorized Officer) Apr. 14, 2022

Any report having not been signed by authorized approver, or having been altered without authorization, or having not been stamped by the "Dedicated Testing/Inspection Stamp" is deemed to be invalid. Copying or excerpting portion of, or altering the content of the report is not permitted without the written authorization of AGC. The test results presented in the report apply only to the tested sample. Any objections to report issued by AGC should be submitted to AGC within 15days after the issuance of the test report. Further enquiry of validity or verification of the test report should be addressed to AGC by agc01@agccert.com.

2. GENERAL INFORMATION

2.1. EUT DESCRIPTION

Operating Frequency Range(s)	2402MHz~2480MHz
The type of the equipment	FHSS adaptive equipment with only one antenna
The number of Hopping Frequencies	79 Channels
Modulation	BR: <input checked="" type="checkbox"/> GFSK EDR: <input checked="" type="checkbox"/> π /4-DQPSK, <input checked="" type="checkbox"/> 8DPSK
Bluetooth Version	V5.0
Hardware Version	Bluetooth-AF0031 V1.0
Software Version	leader.1910.01 V5.0
The maximum RF Output Power	-0.38dBm
Antenna designation	Ceramic Antenna
Antenna Gain	4dBi
Power Supply (Headset)	DC 3.7V by battery
Power Supply(Charging dock)	DC 3.7V by battery or DC 5V by adapter
The extreme operating conditions	Lowest temperature range (LT): -10°C Normal temperature range (NT): 25°C Highest temperature range (HT): 45°C
Geo-location capability	<input type="checkbox"/> Yes <input checked="" type="checkbox"/> No

Note:

1. The above information was declared by the manufacturer.
2. The equipment submitted representative production models.
3. The EUT cannot operated unmodulated.
4. The EUT provides Bluetooth wireless interface operating at 2.4G ISM band (2402MHz-2480MHz).
5. Only the Bluetooth was tested according the standard requirement.
6. The EUT is a stand-alone and portable equipment according to ETSI EN 300 328 V2.2.2.
7. For more details, please refer to the User’s manual of the EUT.
8. The EUT doesn’t suppor BLE.

2.2. SUPPORT EQUIPMENT

Item	Equipment	Mfr/Brand	Model/Type No.	Remark
--	--	--	--	--

2.3. DESCRIPTION OF TEST MODES

Test Mode	Description
BR_TX_2402_1Mbps	Bluetooth BR Transmitting mode (Channel: 2402, Rate: 1Mbps)
BR_TX_2480_1Mbps	Bluetooth BR Transmitting mode (Channel: 2480, Rate: 1Mbps)
EDR_TX_2402_2Mbps	Bluetooth EDR Transmitting mode (Channel: 2402, Rate: 2Mbps)
EDR_TX_2480_2Mbps	Bluetooth EDR Transmitting mode (Channel: 2480, Rate: 2Mbps)
EDR_TX_2402_3Mbps	Bluetooth EDR Transmitting mode (Channel: 2402, Rate: 3Mbps)
EDR_TX_2480_3Mbps	Bluetooth EDR Transmitting mode (Channel: 2480, Rate: 3Mbps)
BR_HOP_NA_1Mbps	Bluetooth BR Hopping mode (Rate: 1Mbps)
EDR_HOP_NA_2Mbps	Bluetooth EDR Hopping mode (Rate: 2Mbps)
EDR_HOP_NA_3Mbps	Bluetooth EDR Hopping mode (Rate: 3Mbps)
BR_RX_2402_1Mbps	Bluetooth BR Receiving mode (Channel: 2402, Rate: 1Mbps)
BR_RX_2480_1Mbps	Bluetooth BR Receiving mode (Channel: 2480, Rate: 1Mbps)
EDR_RX_2402_2Mbps	Bluetooth EDR Receiving mode (Channel: 2402, Rate: 2Mbps)
EDR_RX_2480_2Mbps	Bluetooth EDR Receiving mode (Channel: 2480, Rate: 2Mbps)
EDR_RX_2402_3Mbps	Bluetooth EDR Receiving mode (Channel: 2402, Rate: 3Mbps)
EDR_RX_2480_3Mbps	Bluetooth EDR Receiving mode (Channel: 2480, Rate: 3Mbps)

Note:

1. All modes have been tested and the worst mode test data recording in the test report, if no any other data.

2.4. OBJECTIVE

Perform Radio Spectrum tests for CE Marking according to the provisions of article 3.2 of the Radio Equipment Directive (2014/53/EU) for the BT function of the EUT.

2.5. TEST ITEMS AND THE RESULTS

The EUT has been tested according to ETSI EN 300 328 V2.2.2(2019-07).

ETSI EN 300 328 V2.2.2 (2019-07)	Wideband transmission systems; Data transmission equipment operating in the 2,4 GHz band; Harmonised Standard for access to radio spectrum
---	--

Test items and the results are as bellow:

No.	Basic Standard	Test Type	Result
1	ETSI EN 300 328 4.3.1.2	RF Output Power	Pass
2	ETSI EN 300 328 4.3.1.3	Duty Cycle, Tx-sequence, Tx-gap	N/A
3	ETSI EN 300 328 4.3.1.4	Accumulated transmit time, Frequency Occupation and hopping sequence	Pass
4	ETSI EN 300 328 4.3.1.5	Hopping Frequency Separation	Pass
5	ETSI EN 300 328 4.3.1.6	Medium Utilisation (MU) factor	N/A
6	ETSI EN 300 328 4.3.1.7	Adaptivity (Adaptive Frequency Hopping)	N/A
7	ETSI EN 300 328 4.3.1.8	Occupied Channel Bandwidth	Pass
8	ETSI EN 300 328 4.3.1.9	Transmitter unwanted emission in the out of band domain	Pass
9	ETSI EN 300 328 4.3.1.10	Transmitter unwanted emission in the spurious domain	Pass
10	ETSI EN 300 328 4.3.1.11	Receiver Spurious emissions	Pass
11	ETSI EN 300 328 4.3.1.12	Receiver Blocking	Pass

Note:

1. N/A means it's not applicable to this item.
2. Owing to the maximum declared RF Output power (e.i.r.p.) less than 10 dBm, so the item 2, 5, 6 are not applicable.

2.6. ENVIRONMENTAL CONDITIONS

- Temperature: 15-35°C
- Relative Humidity: 30-60%
- Atmospheric pressure: 86-106kPa

Any report having not been signed by authorized approver, or having been altered without authorization, or having not been stamped by the "Dedicated Testing/Inspection Stamp" is deemed to be invalid. Copying or excerpting portion of, or altering the content of the report is not permitted without the written authorization of AGC. The test results presented in the report apply only to the tested sample. Any objections to report issued by AGC should be submitted to AGC within 15days after the issuance of the test report. Further enquiry of validity or verification of the test report should be addressed to AGC by agc01@agccert.com.

3. MEASUREMENT UNCERTAINTY

The uncertainty is calculated using the methods suggested in the “Guide to the Expression of Uncertainty in Measurement” (GUM) published by ISO.

Item	Measurement Uncertainty
Uncertainty of Radio Frequency	$U_c = \pm 1 \times 10^{-7}$
Uncertainty of total RF power, conducted	$U_c = \pm 0.8 \text{ dB}$
Uncertainty of RF power density, conducted	$U_c = \pm 2.6 \text{ dB}$
Uncertainty of spurious emissions, conducted	$U_c = \pm 2.7 \text{ dB}$
Uncertainty of spurious emissions, radiated	$U_c = \pm 5.4 \text{ dB}$
Uncertainty of Temperature	$U_c = 0.5^\circ \text{ C}$
Uncertainty of Humidity	$U_c = \pm 1 \%$
Uncertainty of DC and low frequency voltages	$U_c = \pm 2 \%$

Any report having not been signed by authorized approver, or having been altered without authorization, or having not been stamped by the “Dedicated Testing/Inspection Stamp” is deemed to be invalid. Copying or excerpting portion of, or altering the content of the report is not permitted without the written authorization of AGC. The test results presented in the report apply only to the tested sample. Any objections to report issued by AGC should be submitted to AGC within 15 days after the issuance of the test report. Further enquiry of validity or verification of the test report should be addressed to AGC by agc01@agccert.com.

4. IDENTIFICATION OF THE RESPONSIBLE TESTING LOCATION

Site	Attestation of Global Compliance (Shenzhen) Co., Ltd.
Location	1-2/F, Building 19, Junfeng Industrial Park, Chongqing Road, Heping Community, Fuhai Street, Bao'an District, Shenzhen, Guangdong, China

LIST OF EQUIPMENTS USED

Description	Manufacturer	Model No.	S/N	Cal. Date	Cal. Due
MXG X-Series Vector Signal Generator	Aglient	N5182B	MY53050647	Aug. 18, 2021	Aug. 17, 2022
RF Analog Signal Generator	Aglient	N5171B	MY53050474	Aug. 18, 2021	Aug. 17, 2022
Signal Analyzer	Aglient	N9020A	MY52090123	Sep. 06, 2021	Sep. 05, 2022
USB Wideband Power Sensor	Aglient	U2021XA	MY54110007	Mar. 04, 2022	Mar. 03, 2023
USB Wideband Power Sensor	Aglient	U2021XA	MY54110009	Mar. 04, 2022	Mar. 03, 2023
USB Wideband Power Sensor	Aglient	U2021XA	MY541100B	Mar. 04, 2022	Mar. 03, 2023
Universal Radio Communication Tester	R&S	CMW270	101933	Aug. 18, 2021	Aug. 17, 2022
Attenuator	ZHINAN	E-002	N/A	Sep. 03, 2020	Sep. 02, 2022
Power splitter	Mini-Circuits	ZFRSC-183-s	3122	N/A	N/A
2.4GHz Filter	EM Electronics	N/A	N/A	Mar. 18, 2022	Mar. 19, 2024
Small environment tester	ESPEC	SH-242	93008290	Sep. 03, 2020	Sep. 02, 2022
Preamplifier Assembly	ETS	3117PA	00225134	Sep. 03, 2020	Sep. 02, 2022
Wideband Antenna	SCHWARZBEC K	VULB9168	VULB9168-494	Jan. 08, 2021	Jan. 07, 2023
Wideband Antenna	SCHWARZBEC K	VULB9168	D69250	Apr. 28, 2021	Apr. 27, 2023
Biconilog Antenn	ETS	3142C	00060447	N/A	N/A
Double-Ridged Waveguide Horn	ETS	3117	00154520	Sep. 06, 2021	Sep. 05, 2023
Double-Ridged Waveguide Horn	ETS	3117	00034609	Apr. 23, 2021	Apr. 22, 2023
Temperature and humidity box	ESPEC	SH-242	93008290	Sep. 03, 2020	Sep. 02, 2022
RF Cable	Harbour	FLCA-7312-80-1000S2	FL0000169	Dec. 07, 2020	Dec. 06, 2022

Any report having not been signed by authorized approver, or having been altered without authorization, or having not been stamped by the "Dedicated Testing/Inspection Stamp" is deemed to be invalid. Copying or excerpting portion of, or altering the content of the report is not permitted without the written authorization of AGC. The test results presented in the report apply only to the tested sample. Any objections to report issued by AGC should be submitted to AGC within 15days after the issuance of the test report. Further enquiry of validity or verification of the test report should be addressed to AGC by agc01@agccert.com.

5. ETSI EN 300 328 REQUIREMENTS

5.1. RF OUTPUT POWER

5.1.1 LIMIT

RF Output Power \leq 100mW (20dBm) over Normal and Extreme conditions.

5.1.2 MEASUREMENT PROCEDURE

- 1) Use a fast power sensor and set the samples speed 1MS/s or faster.
- 2) Connect one power sensor to each transmit port, Trigger the power sensors so that they start sampling at the same time. For each instant in time, sum the power of the individual samples of all ports and store them. Use these stored samples in all following steps.
- 3) Find the start and stop times of each burst in the stored measurement samples.
- 4) Between the start and stop times of each individual burst calculate the RMS power over the burst. Save these P burst values, as well as the start and stop times for each burst.
- 5) The highest of all P burst values (Value "A" in dBm) will be used for maximum e.i.r.p calculations.
- 6) The cable loss and attenuator factor shall be considered to the value "A".
- 6) Add the (stated) antenna assembly gain "G" in dBi of the individual antenna. If applicable, add the additional beamforming gain "Y" in dB.
- 7) The RF output power (P) shall be calculated using the formula: $P=A+G+Y$

5.1.3 TEST CONFIGURATION

Temperature and Voltage Measurement (under normal and extreme test conditions)

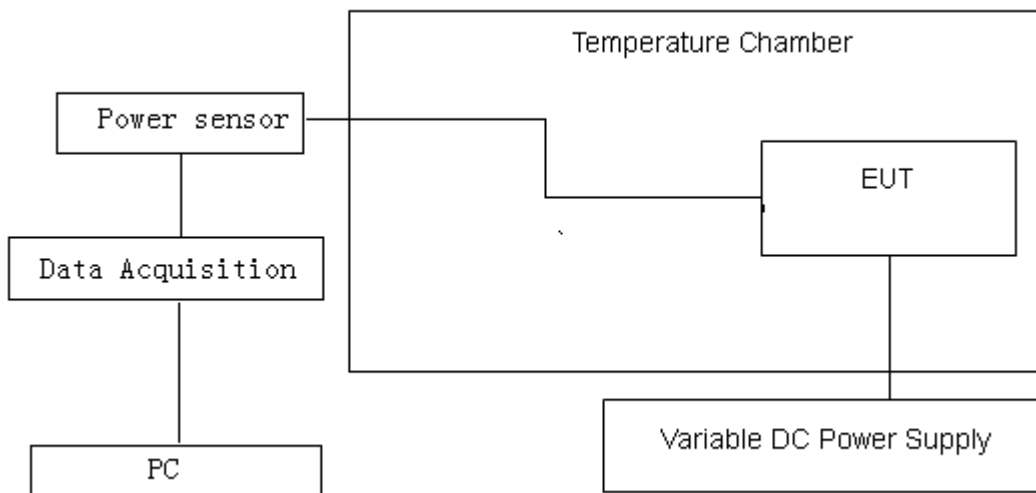

Any report having not been signed by authorized approver, or having been altered without authorization, or having not been stamped by the "Dedicated Testing/Inspection Stamp" is deemed to be invalid. Copying or excerpting portion of, or altering the content of the report is not permitted without the written authorization of AGC. The test results presented in the report apply only to the tested sample. Any objections to report issued by AGC should be submitted to AGC within 15days after the issuance of the test report. Further enquiry of validity or verification of the test report should be addressed to AGC by agc01@agccert.com.

5.1.4 MEASUREMENT RESULTS

Test Data of RF Output Power					
Test Mode	RF Output Power [dBm]			Limit [dBm]	Verdict
	NT	LT	HT		
BR_HOP_NA_1Mbps	2.10	2.09	2.09	20	Pass
EDR_HOP_NA_2Mbps	-0.38	-0.44	-0.41	20	Pass
EDR_HOP_NA_3Mbps	-1.36	-1.38	-1.36	20	Pass

Any report having not been signed by authorized approver, or having been altered without authorization, or having not been stamped by the "Dedicated Testing/Inspection Stamp" is deemed to be invalid. Copying or excerpting portion of, or altering the content of the report is not permitted without the written authorization of AGC. The test results presented in the report apply only to the tested sample. Any objections to report issued by AGC should be submitted to AGC within 15days after the issuance of the test report. Further enquiry of validity or verification of the test report should be addressed to AGC by agc01@agccert.com.

Test Graphs of RF Output Power

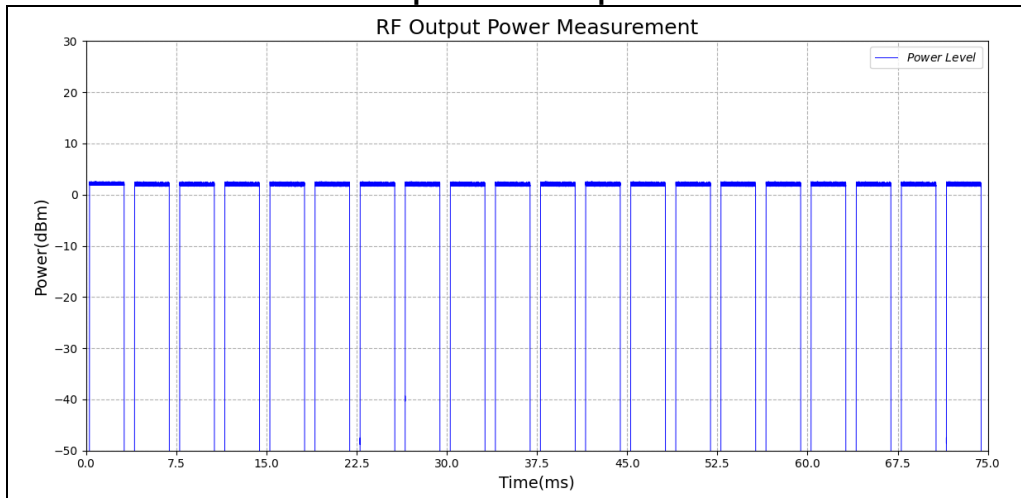

Test_Graph_BR_HOP_NA_1Mbps_Power_NT

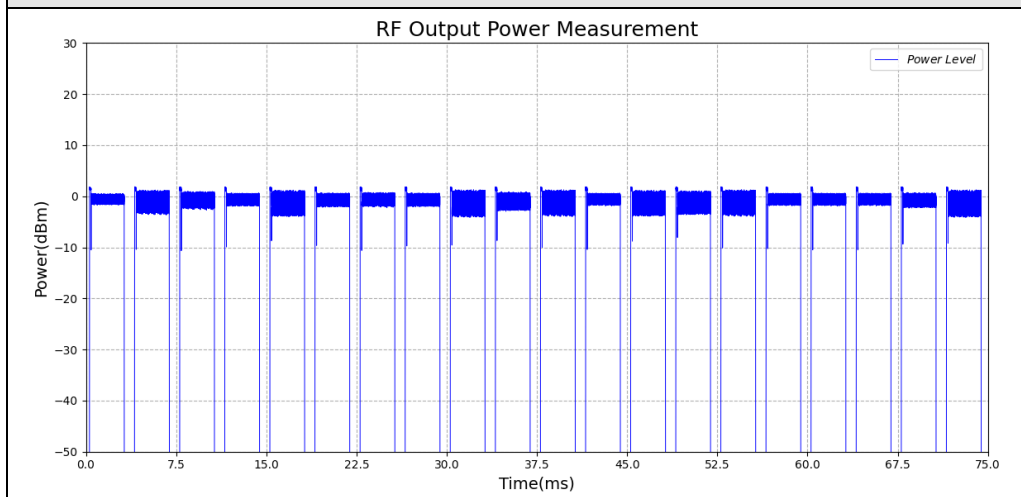

Test_Graph_EDR_HOP_NA_2Mbps_Power_NT

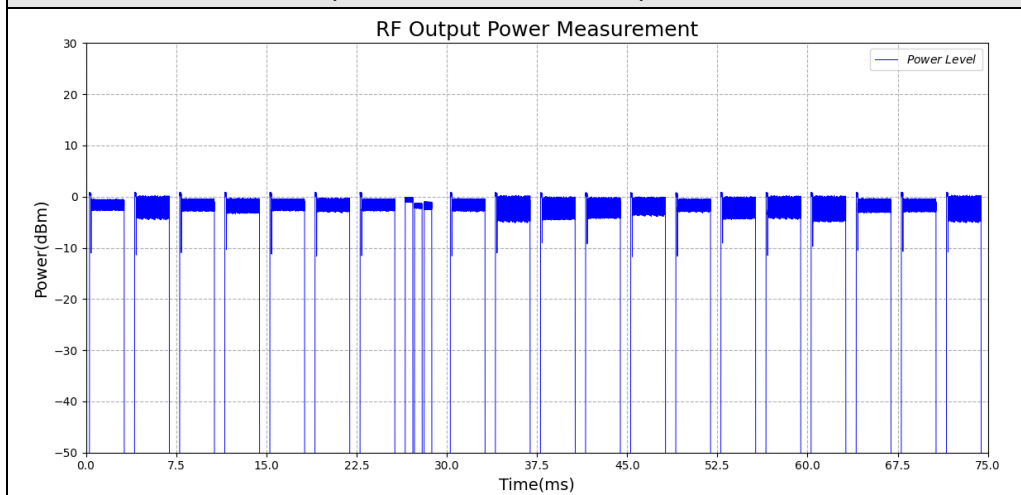

Test_Graph_EDR_HOP_NA_3Mbps_Power_NT

Note: Only the data of worst case is reported as above.

Any report having not been signed by authorized approver, or having been altered without authorization, or having not been stamped by the "Dedicated Testing/Inspection Stamp" is deemed to be invalid. Copying or excerpting portion of, or altering the content of the report is not permitted without the written authorization of AGC. The test results presented in the report apply only to the tested sample. Any objections to report issued by AGC should be submitted to AGC within 15days after the issuance of the test report. Further enquiry of validity or verification of the test report should be addressed to AGC by agc01@agccert.com.

5.2. ACCUMULATED TRANSMIT TIME, FREQUENCY OCCUPIATION AND HOPPING SEQUENCE

5.2.1 LIMIT

ACCUMULATED TRANSMIT TIME	
CONDITION	LIMIT
<input type="checkbox"/> Non-adaptive frequency hopping systems	≤ 15 ms
<input checked="" type="checkbox"/> Adaptive frequency hopping systems	≤ 400 ms

FREQUENCY OCCUPATION	
CONDITION	LIMIT (OPTION 1)
<input type="checkbox"/> Non-adaptive frequency hopping systems	Each hopping frequency of the hopping sequence shall be occupied at least once within a period not exceeding four times the product of the dwell time and the number of hopping frequencies in use.
<input checked="" type="checkbox"/> Adaptive frequency hopping systems	

HOPPING SEQUENCE(S)	
CONDITION	LIMIT
<input type="checkbox"/> Non-adaptive frequency hopping systems	≥5 hopping frequencies or 5/minimum Hopping Frequency Separation in MHz, whichever is the greater.
<input checked="" type="checkbox"/> Adaptive frequency hopping systems	Operating frequency band ≥58.45MHz (Operating over a minimum of 70 % of the operating in the band 2,4 GHz to 2,4835 GHz)
	≥15 hopping frequencies or 15/minimum Hopping Frequency Separation in MHz, whichever is the greater.

5.2.2 TEST PROCEDURE

Please refer to ETSI EN300328 V2.2.2 Section 5.4.4

5.2.3 TEST CONFIGURATION

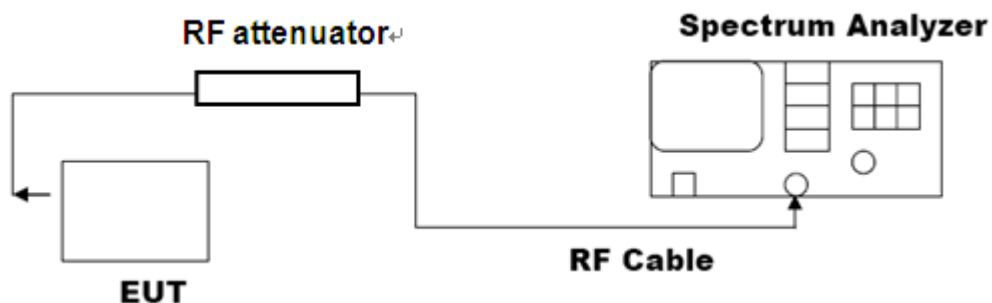

Any report having not been signed by authorized approver, or having been altered without authorization, or having not been stamped by the "Dedicated Testing/Inspection Stamp" is deemed to be invalid. Copying or excerpting portion of, or altering the content of the report is not permitted without the written authorization of AGC. The test results presented in the report apply only to the tested sample. Any objections to report issued by AGC should be submitted to AGC within 15days after the issuance of the test report. Further enquiry of validity or verification of the test report should be addressed to AGC by agc01@agccert.com.

5.2.4 TEST RESULTS

Test Data of Accumulated Transmit Time, Frequency Occupation						
Test Mode	Channel (MHz)	Accumulated transmit time (ms)	Limit (ms)	Frequency Occupation (pcs)	Limit (pcs)	Verdict
BR_HOP_NA_1Mbps	2402	310.932	≤400	6	≥1	Pass
	2480	322.448	≤400	2	≥1	Pass

- Note:** 1) All the modes had been tested, but only the worst data recorded in the report.
 2) The Accumulated transmit time and Dwell Time are calculated by a computing device using an appropriate software application or program.
 3) Sweep time for Frequency Occupation= Dwell Time*4*79.

Any report having not been signed by authorized approver, or having been altered without authorization, or having not been stamped by the "Dedicated Testing/Inspection Stamp" is deemed to be invalid. Copying or excerpting portion of, or altering the content of the report is not permitted without the written authorization of AGC. The test results presented in the report apply only to the tested sample. Any objections to report issued by AGC should be submitted to AGC within 15days after the issuance of the test report. Further enquiry of validity or verification of the test report should be addressed to AGC by agc01@agccert.com.

Test Graphs of Accumulated Transmit Time, Frequency Occupation

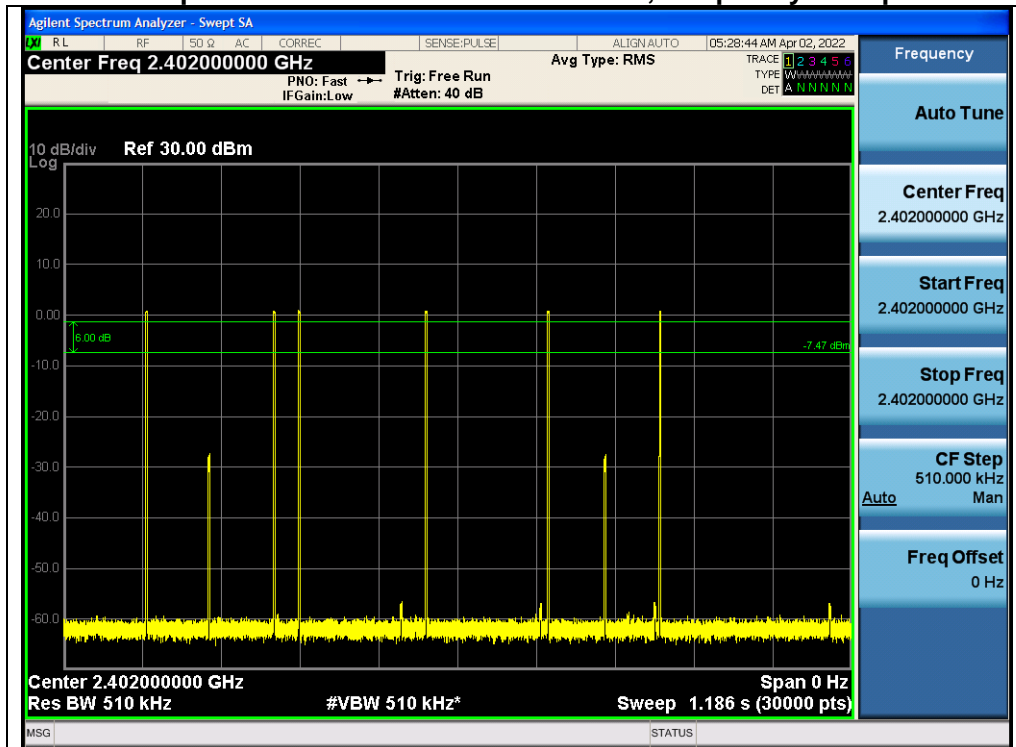

Test_Graph_BR_HOP_NA_1Mbps_2402_Frequency Occupation

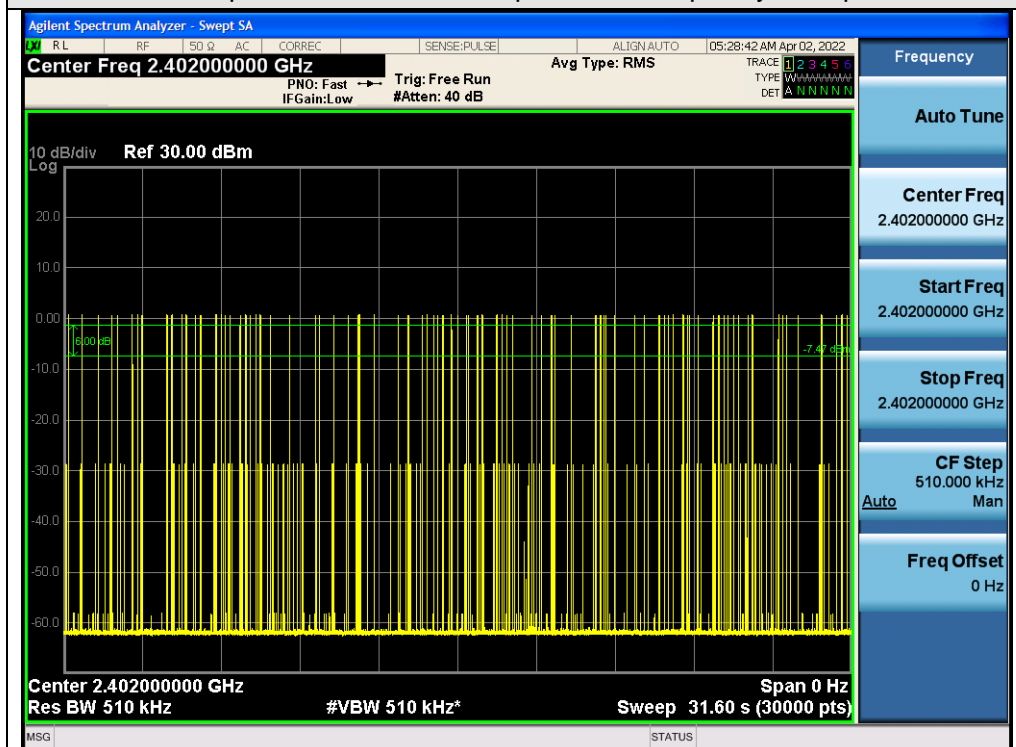

Test_Graph_BR_HOP_NA_1Mbps_2402_Accumulated Transmit Time

Any report having not been signed by authorized approver, or having been altered without authorization, or having not been stamped by the "Dedicated Testing/Inspection Stamp" is deemed to be invalid. Copying or excerpting portion of, or altering the content of the report is not permitted without the written authorization of AGC. The test results presented in the report apply only to the tested sample. Any objections to report issued by AGC should be submitted to AGC within 15days after the issuance of the test report. Further enquiry of validity or verification of the test report should be addressed to AGC by agc01@agccert.com.

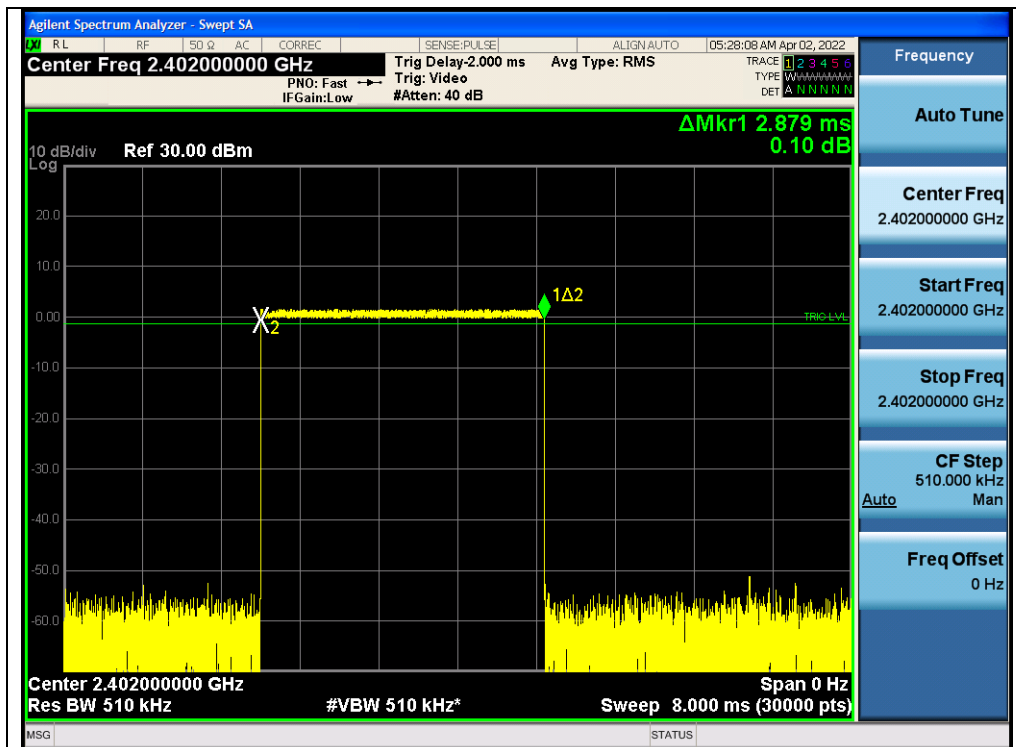

Test_Graph_BR_HOP_NA_1Mbps_2402_Burst Time

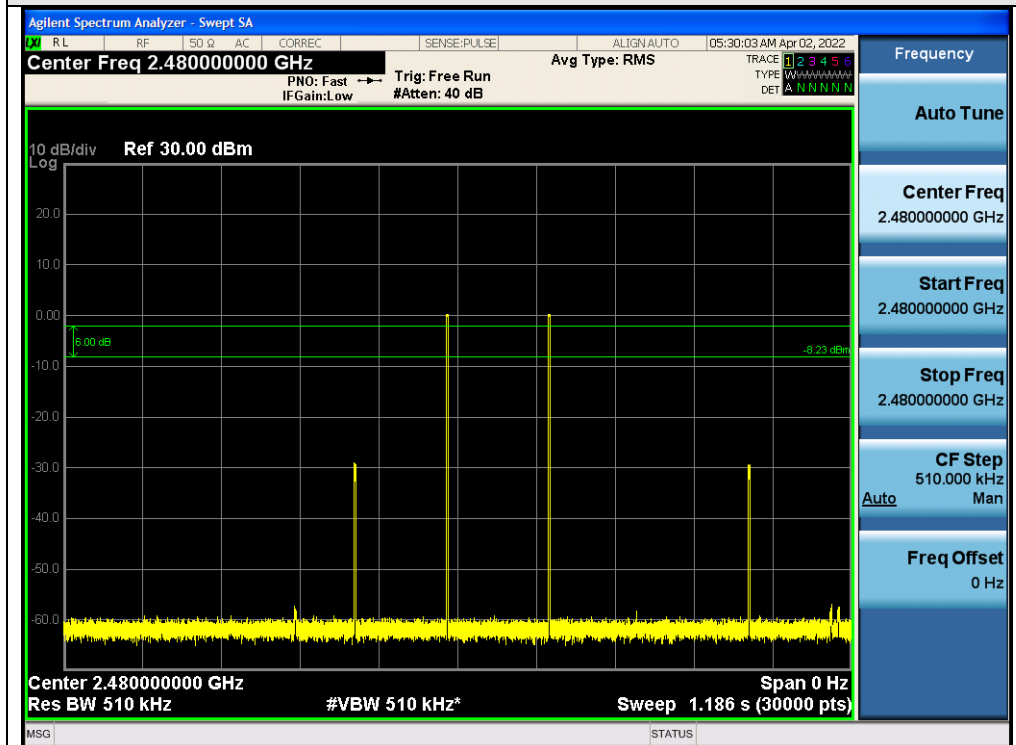

Test_Graph_BR_HOP_NA_1Mbps_2480_Frequency Occupation

Any report having not been signed by authorized approver, or having been altered without authorization, or having not been stamped by the "Dedicated Testing/Inspection Stamp" is deemed to be invalid. Copying or excerpting portion of, or altering the content of the report is not permitted without the written authorization of AGC. The test results presented in the report apply only to the tested sample. Any objections to report issued by AGC should be submitted to AGC within 15 days after the issuance of the test report. Further enquiry of validity or verification of the test report should be addressed to AGC by agc01@agccert.com.

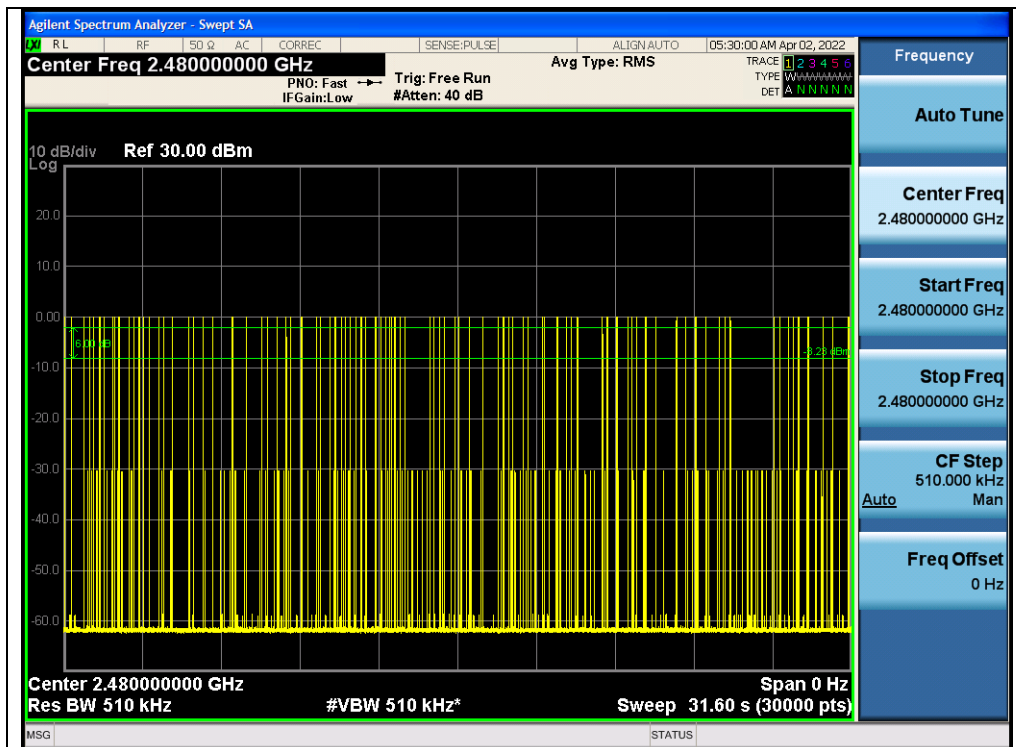

Test_Graph_BR_HOP_NA_1Mbps_2480_Accumulated Transmit Time

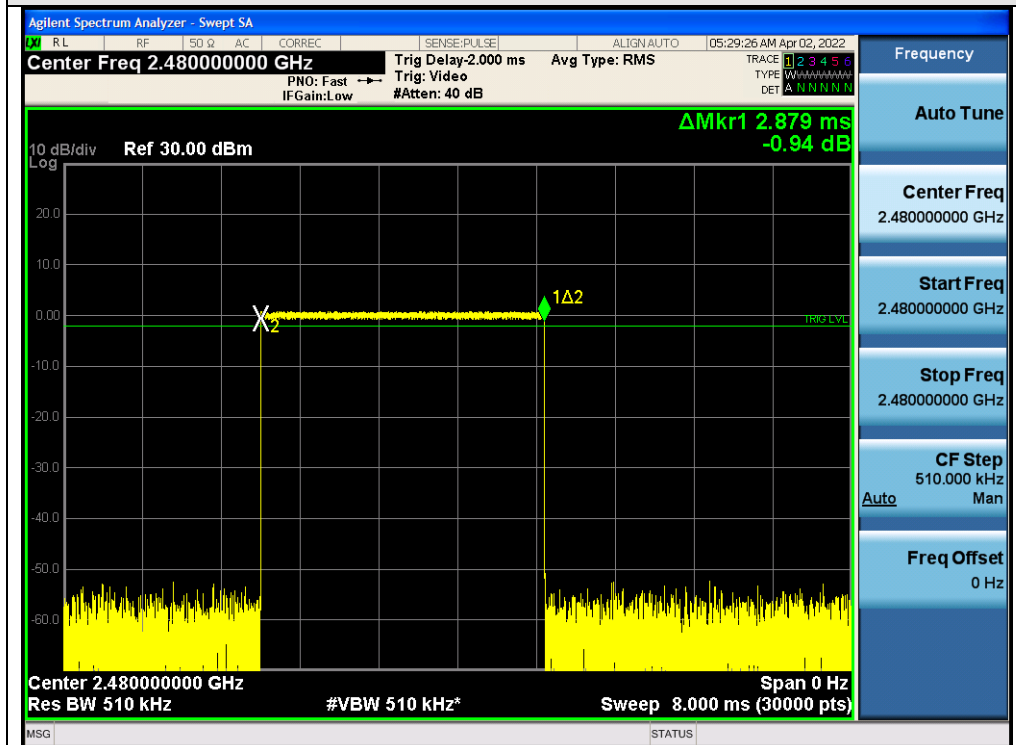

Test_Graph_BR_HOP_NA_1Mbps_2480_Burst Time

Any report having not been signed by authorized approver, or having been altered without authorization, or having not been stamped by the "Dedicated Testing/Inspection Stamp" is deemed to be invalid. Copying or excerpting portion of, or altering the content of the report is not permitted without the written authorization of AGC. The test results presented in the report apply only to the tested sample. Any objections to report issued by AGC should be submitted to AGC within 15days after the issuance of the test report. Further enquiry of validity or verification of the test report should be addressed to AGC by agc01@agccert.com.

TEST RESULT FOR HOPPING SEQUENCE

Channel	Frequency (GHz)	Channel	Frequency (GHz)
01	2.402	42	2.443
02	2.403	43	2.444
03	2.404	44	2.445
04	2.405	45	2.446
05	2.406	46	2.447
06	2.407	47	2.448
07	2.408	48	2.449
08	2.409	49	2.450
09	2.410	50	2.451
10	2.411	51	2.452
11	2.412	52	2.453
12	2.413	53	2.454
13	2.414	54	2.455
14	2.415	55	2.456
15	2.416	56	2.457
16	2.417	57	2.458
17	2.418	58	2.459
18	2.419	59	2.460
19	2.420	60	2.461
20	2.421	61	2.462
21	2.422	62	2.463
22	2.423	63	2.464
23	2.424	64	2.465
24	2.420	65	2.466
25	2.426	66	2.467
26	2.427	67	2.468
27	2.428	68	2.469
28	2.429	69	2.470
29	2.430	70	2.471
30	2.431	71	2.472
31	2.432	72	2.473
32	2.433	73	2.474
33	2.434	74	2.475
34	2.435	75	2.476
35	2.436	76	2.477
36	2.437	77	2.478
37	2.438	78	2.479
38	2.439	79	2.480
39	2.440		
40	2.441		
41	2.442		

Any report having not been signed by authorized approver, or having been altered without authorization, or having not been stamped by the "Dedicated Testing/Inspection Stamp" is deemed to be invalid. Copying or excerpting portion of, or altering the content of the report is not permitted without the written authorization of AGC. The test results presented in the report apply only to the tested sample. Any objections to report issued by AGC should be submitted to AGC within 15days after the issuance of the test report. Further enquiry of validity or verification of the test report should be addressed to AGC by agc01@agccert.com.

Test Data of Hopping Sequence					
Test Mode	Number of hopping frequencies	Limit	-20dBc Hopping BW [MHz]	Limit [MHz]	Verdict
BR_HOP_NA_1Mbps	79	≥15	79.591	≥58.45	Pass

Test Graphs of Hopping Sequence

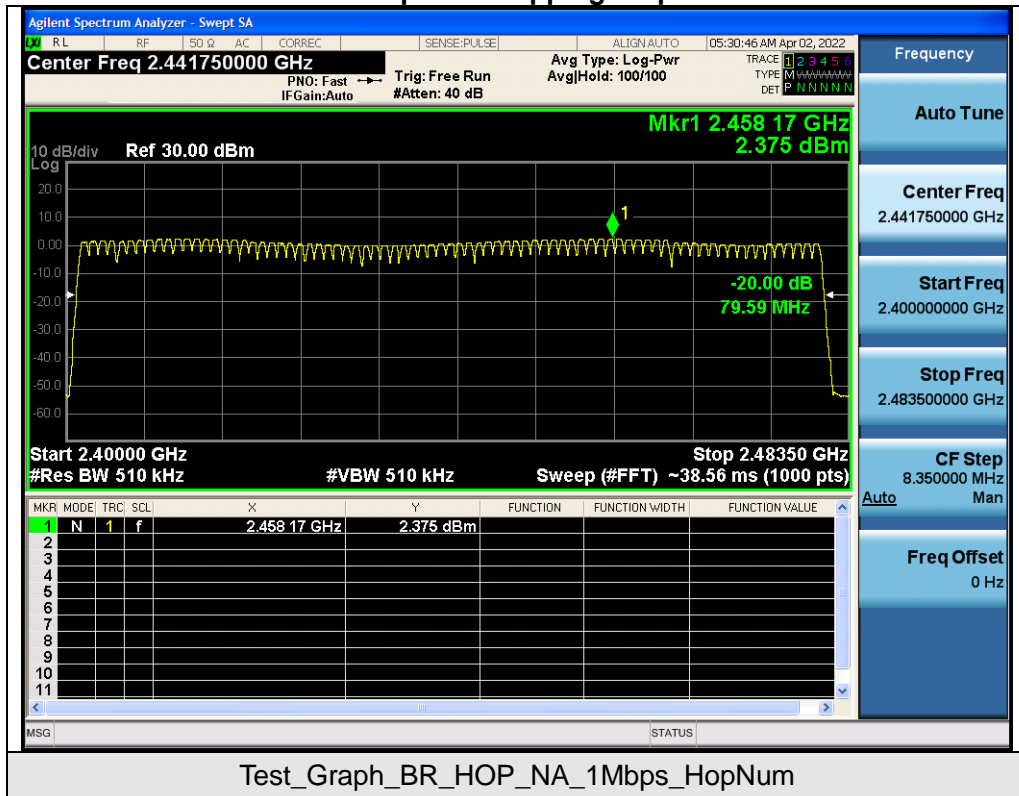

Test_Graph_BR_HOP_NA_1Mbps_HopNum

Note: The modulation used during test is GFSK and this is the worst case.

Any report having not been signed by authorized approver, or having been altered without authorization, or having not been stamped by the “Dedicated Testing/Inspection Stamp” is deemed to be invalid. Copying or excerpting portion of, or altering the content of the report is not permitted without the written authorization of AGC. The test results presented in the report apply only to the tested sample. Any objections to report issued by AGC should be submitted to AGC within 15days after the issuance of the test report. Further enquiry of validity or verification of the test report should be addressed to AGC by agc01@agccert.com.

5.3. HOPPING FREQUENCY SEPARATION

5.3.1 LIMIT

For Non-adaptive frequency hopping systems:

The minimum Hopping Frequency Separation shall be equal to Occupied Channel Bandwidth (see clause 4.3.1.7) of a single hop, with a minimum separation of 100 kHz.

For Adaptive frequency hopping systems:

The minimum Hopping Frequency Separation shall be 100 kHz.

5.3.2 TEST PROCEDURE

Please refer to ETSI EN300328 V2.2.2 Section 5.4.5

5.3.3 TEST CONFIGURATION

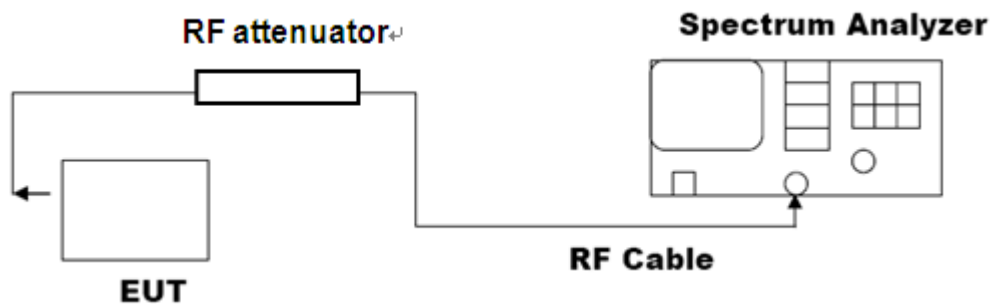

5.3.4 TEST RESULTS

Test Data of Hopping Frequency Separation			
Test Mode	Hopping Frequency Separation [MHz]	Limit [MHz]	Verdict
BR_HOP_NA_1Mbps	0.917	≥0.1	Pass

Test Graphs of Hopping Sequence

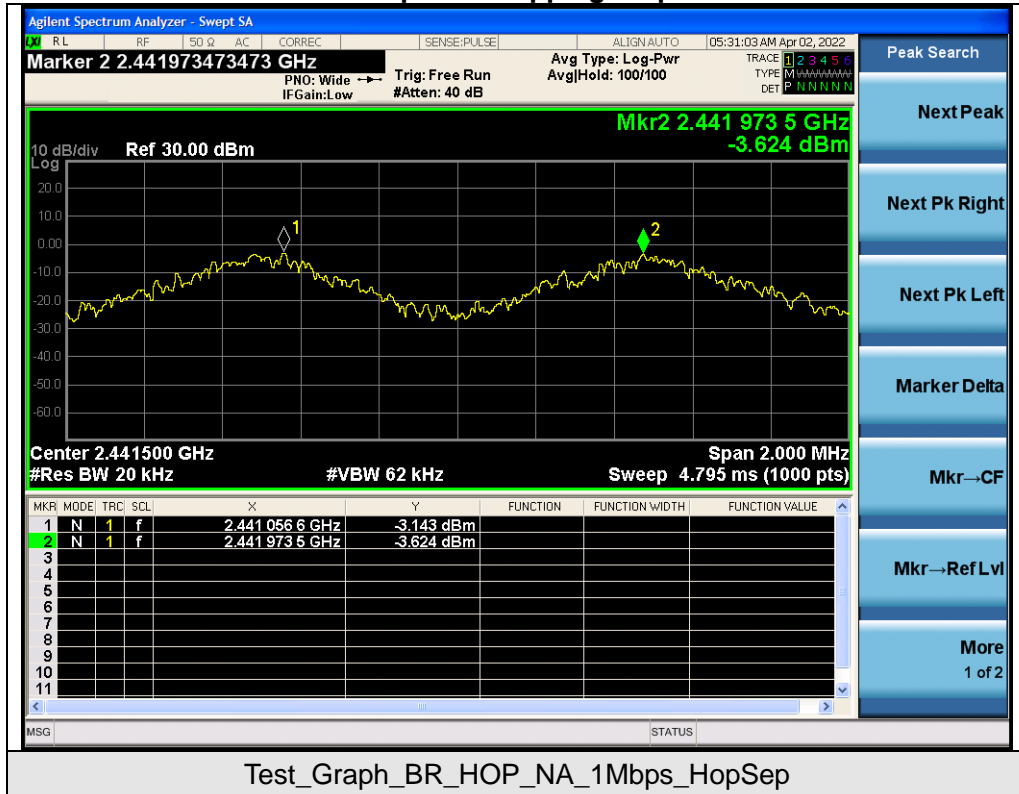

Note: The modulation used during test is GFSK and this is the worst case.

Any report having not been signed by authorized approver, or having been altered without authorization, or having not been stamped by the “Dedicated Testing/Inspection Stamp” is deemed to be invalid. Copying or excerpting portion of, or altering the content of the report is not permitted without the written authorization of AGC. The test results presented in the report apply only to the tested sample. Any objections to report issued by AGC should be submitted to AGC within 15days after the issuance of the test report. Further enquiry of validity or verification of the test report should be addressed to AGC by agc01@agccert.com.

5.4. OCCUPIED CHANNEL BANDWIDTH

5.4.1 LIMIT

The Occupied Channel Bandwidth shall fall completely within the band 2400MHz to 2483.5MHz.

5.4.2 TEST PROCEDURE

1)The spectrum analyser shall be used the following settings:

Centre Frequency: The centre frequency of the channel under test

Resolution BW: ~1% of the span without going below 1%

Video BW: 3×RBW

Span: 2×OBW

Detector: RMS

Trace mode: Max Hold

2) Wait until the trace is completed, find the peak value of the trace and place the analyser marker on this peak.

3) Use the 99 % bandwidth function of the spectrum analyser to measure the Occupied Channel Bandwidth of the UUT. This value shall be recorded.

5.4.3 TEST CONFIGURATION

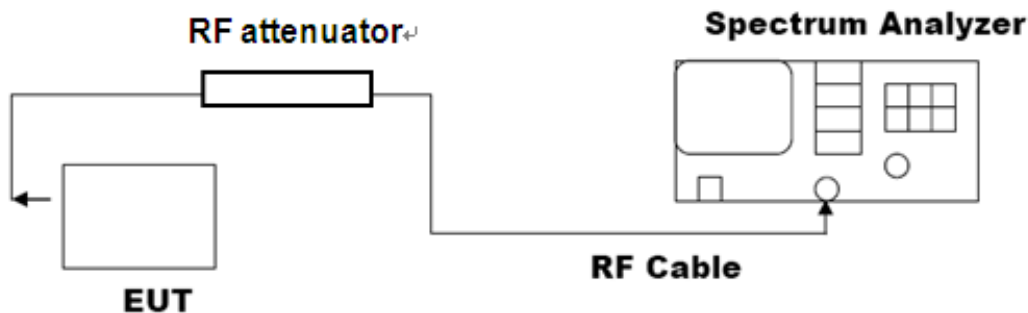

5.4.4 TEST RESULTS

Test Data of Occupied Channel Bandwidth					
Test Mode	Occupied Channel Bandwidth [MHz]			Limit [MHz]	Verdict
	OCB	FL	FH		
BR_2402_1Mbps	0.917	2401.541	2402.458	2400 to 2483.5	Pass
BR_2480_1Mbps	0.903	2479.546	2480.449	2400 to 2483.5	Pass
EDR_2402_2Mbps	1.200	2401.398	2402.599	2400 to 2483.5	Pass
EDR_2480_2Mbps	1.191	2479.400	2480.592	2400 to 2483.5	Pass
EDR_2402_3Mbps	1.210	2401.388	2402.598	2400 to 2483.5	Pass
EDR_2480_3Mbps	1.202	2479.392	2480.595	2400 to 2483.5	Pass

Any report having not been signed by authorized approver, or having been altered without authorization, or having not been stamped by the "Dedicated Testing/Inspection Stamp" is deemed to be invalid. Copying or excerpting portion of, or altering the content of the report is not permitted without the written authorization of AGC. The test results presented in the report apply only to the tested sample. Any objections to report issued by AGC should be submitted to AGC within 15days after the issuance of the test report. Further enquiry of validity or verification of the test report should be addressed to AGC by agc01@agccert.com.

Attestation of Global Compliance(Shenzhen)Co., Ltd

Attestation of Global Compliance(Shenzhen)Std & Tech Co., Ltd

Tel: +86-755 2523 4088 E-mail: agc@agccert.com Web: http://www.agccert.com/

Test Graphs of Occupied Channel Bandwidth

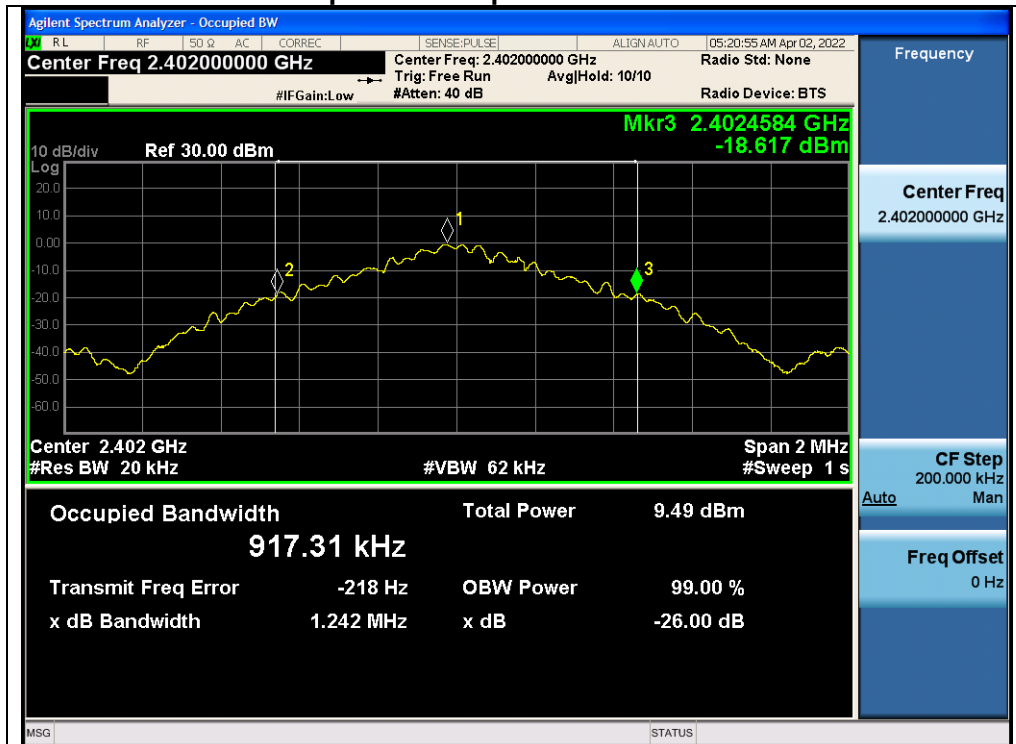

Test_Graph_BR_2402_1Mbps_OBW

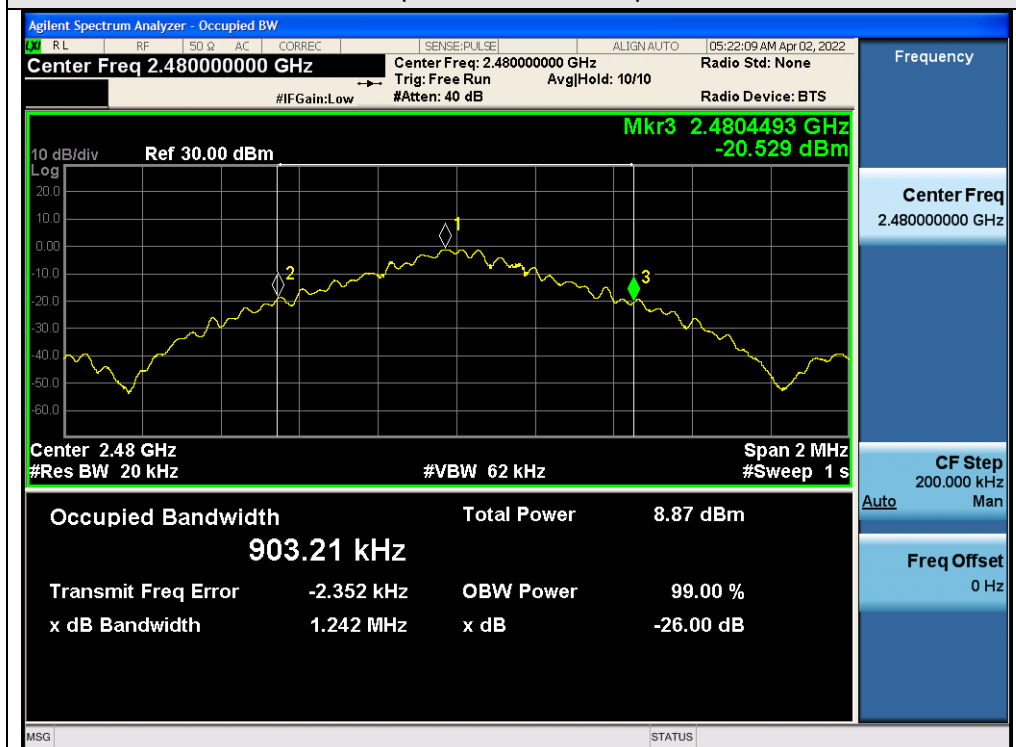

Test_Graph_BR_2480_1Mbps_OBW

Any report having not been signed by authorized approver, or having been altered without authorization, or having not been stamped by the "Dedicated Testing/Inspection Stamp" is deemed to be invalid. Copying or excerpting portion of, or altering the content of the report is not permitted without the written authorization of AGC. The test results presented in the report apply only to the tested sample. Any objections to report issued by AGC should be submitted to AGC within 15 days after the issuance of the test report. Further enquiry of validity or verification of the test report should be addressed to AGC by agc01@agccert.com.

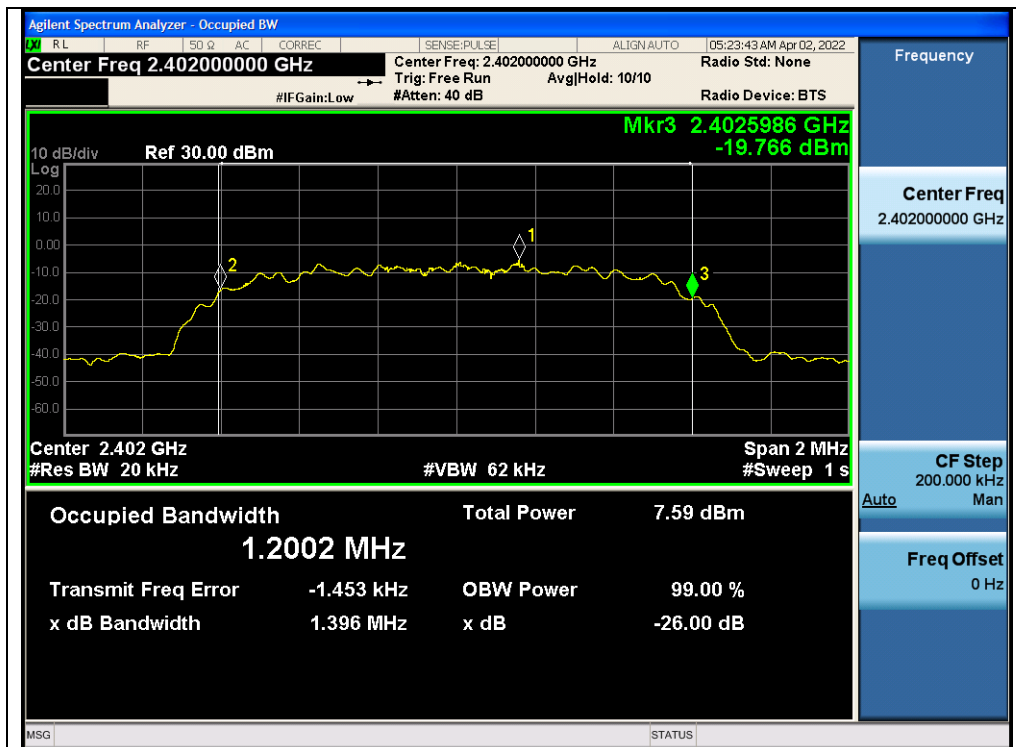

Test_Graph_EDR_2402_2Mbps_OBW

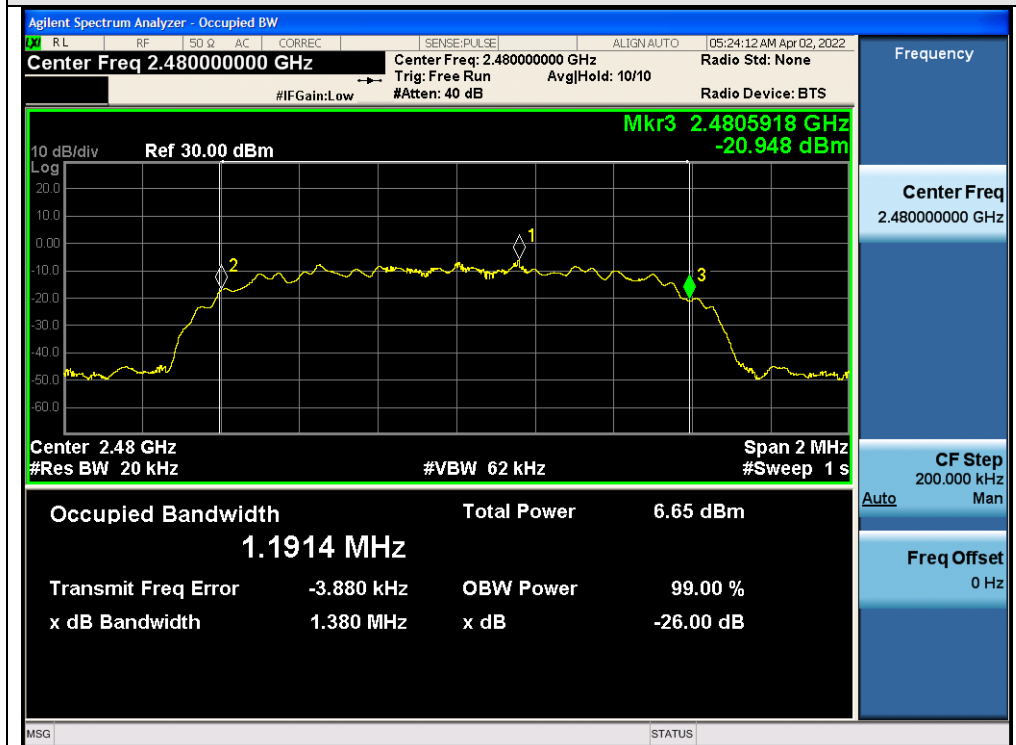

Test_Graph_EDR_2480_2Mbps_OBW

Any report having not been signed by authorized approver, or having been altered without authorization, or having not been stamped by the "Dedicated Testing/Inspection Stamp" is deemed to be invalid. Copying or excerpting portion of, or altering the content of the report is not permitted without the written authorization of AGC. The test results presented in the report apply only to the tested sample. Any objections to report issued by AGC should be submitted to AGC within 15days after the issuance of the test report. Further enquiry of validity or verification of the test report should be addressed to AGC by agc01@agccert.com.

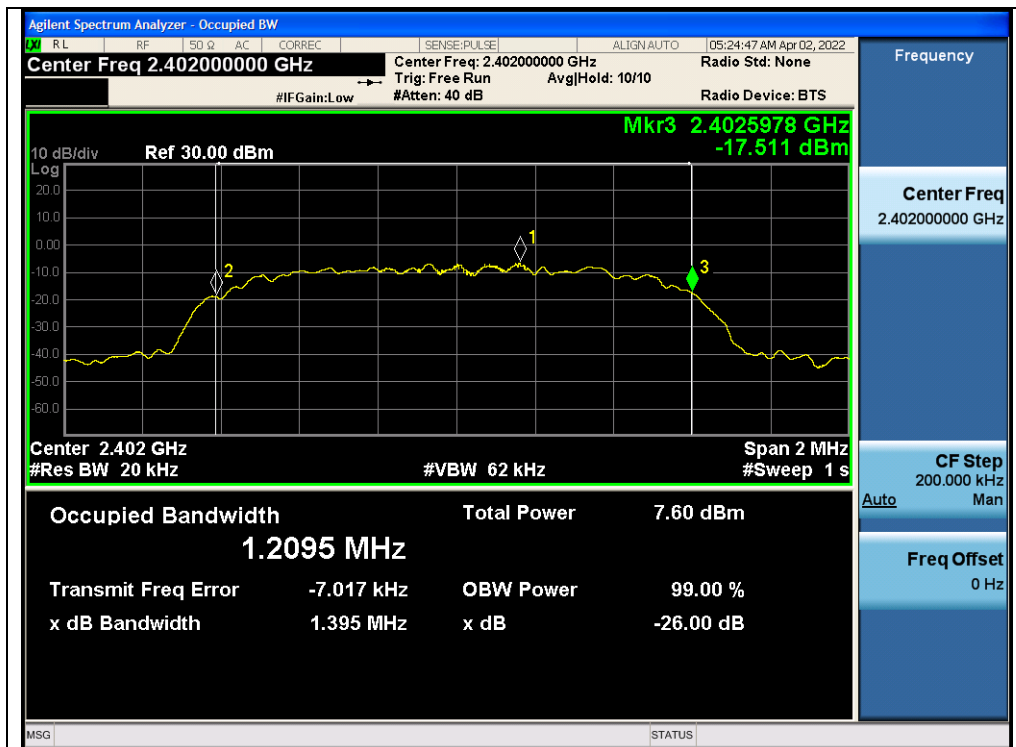

Test_Graph_EDR_2402_3Mbps_OBW

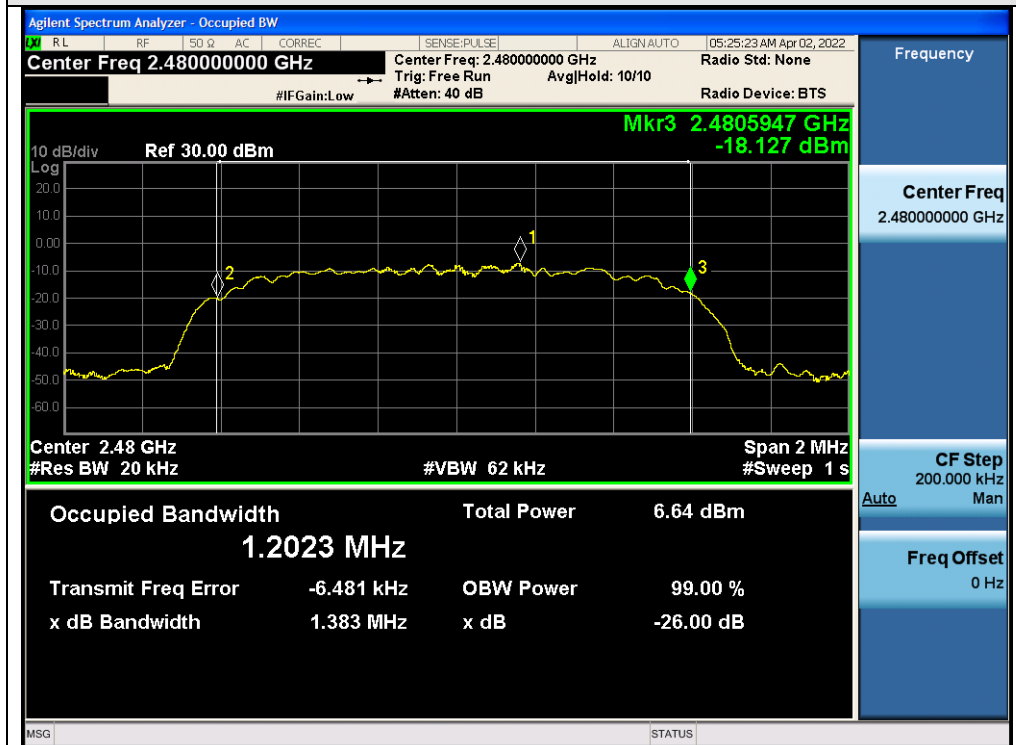

Test_Graph_EDR_2480_3Mbps_OBW

Any report having not been signed by authorized approver, or having been altered without authorization, or having not been stamped by the "Dedicated Testing/Inspection Stamp" is deemed to be invalid. Copying or excerpting portion of, or altering the content of the report is not permitted without the written authorization of AGC. The test results presented in the report apply only to the tested sample. Any objections to report issued by AGC should be submitted to AGC within 15days after the issuance of the test report. Further enquiry of validity or verification of the test report should be addressed to AGC by agc01@agccert.com.

5.5. TRANSMITTER UNWANTED EMISSIONS IN THE OUT OF BAND DOMAIN

5.5.1 LIMIT

The transmitter unwanted emissions in the out-of-band domain but outside the allocated band, shall not exceed the values provided by the mask.

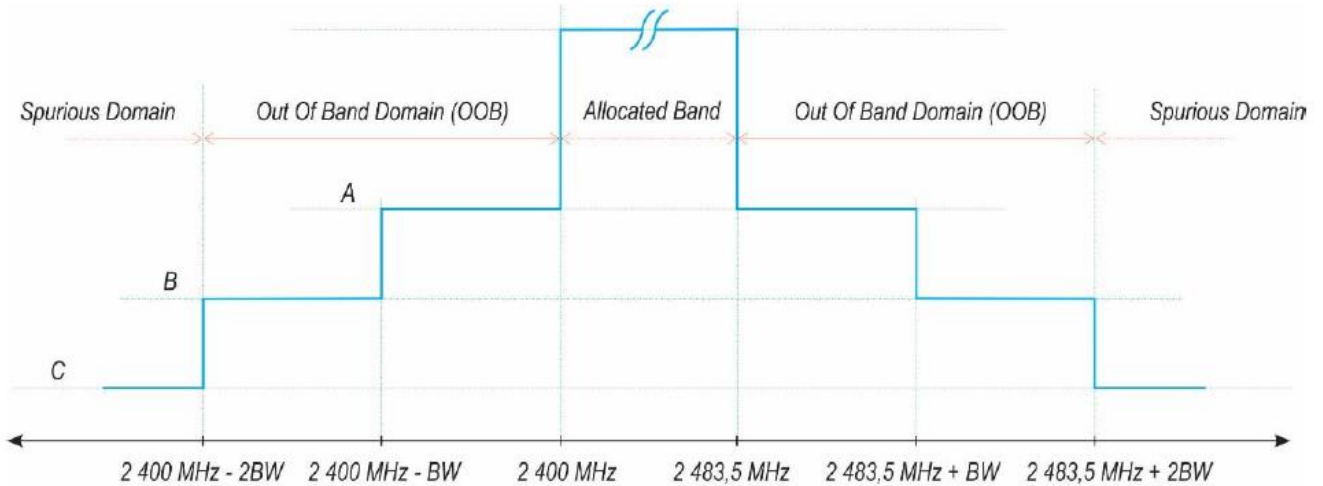

A: -10 dBm/MHz e.i.r.p.
B: -20 dBm/MHz e.i.r.p.
C: Spurious Domain limits

BW = Occupied Channel Bandwidth in MHz or 1 MHz whichever is greater

Any report having not been signed by authorized approver, or having been altered without authorization, or having not been stamped by the "Dedicated Testing/Inspection Stamp" is deemed to be invalid. Copying or excerpting portion of, or altering the content of the report is not permitted without the written authorization of AGC. The test results presented in the report apply only to the tested sample. Any objections to report issued by AGC should be submitted to AGC within 15days after the issuance of the test report. Further enquiry of validity or verification of the test report should be addressed to AGC by agc01@agccert.com.

5.5.2 TEST PROCEDURE

1) The spectrum analyser shall be used the following settings:

Centre Frequency: 2484MHz

Resolution BW: 1MHz; Video BW: 3MHz; Span: 0Hz; Detector: RMS

Trace mode: Max Hold; Sweep Points: 5000

2) (segment 2 483.5 MHz to 2 483.5 MHz + BW)

Adjust the trigger level to select the transmissions with the highest power level.

Increase the centre frequency in steps of 1 MHz and repeat this measurement for every 1 MHz segment within the range 2 483.5 MHz to 2 483.5 MHz + BW.

3)Segment 2 483.5 MHz + BW to 2 483.5 MHz + 2BW

Change the centre frequency of the analyser to 2 484 MHz + BW and perform the measurement for the first 1 MHz segment within range 2 483.5 MHz + BW to 2 483.5 MHz + 2BW. Increase the centre frequency in 1 MHz steps and repeat the measurements to cover this whole range. The centre frequency of the last 1 MHz segment shall be set to 2 483,5 MHz + 2 BW – 0.5 MHz.

4)Segment 2 400 MHz - BW to 2 400 MHz

Change the centre frequency of the analyser to 2 399.5 MHz and perform the measurement for the first 1 MHz segment within range 2 400 MHz - BW to 2 400 MHz Reduce the centre frequency in 1 MHz steps and repeat the measurements to cover this whole range. The centre frequency of the last 1 MHz segment shall be set to 2 400 MHz - 2BW + 0.5 MHz.

5)Segment 2 400 MHz - 2BW to 2 400 MHz - BW

Change the centre frequency of the analyser to 2 399,5 MHz - BW and perform the measurement for the first 1 MHz segment within range 2 400 MHz - 2BW to 2 400 MHz - BW. Reduce the centre frequency in 1 MHz steps and repeat the measurements to cover this whole range. The centre frequency of the last 1 MHz segment shall be set to 2 400 MHz - 2BW + 0.5 MHz.

6)The cable loss and attenuator factor shall be considered to the test result.

5.5.3 TEST CONFIGURATION

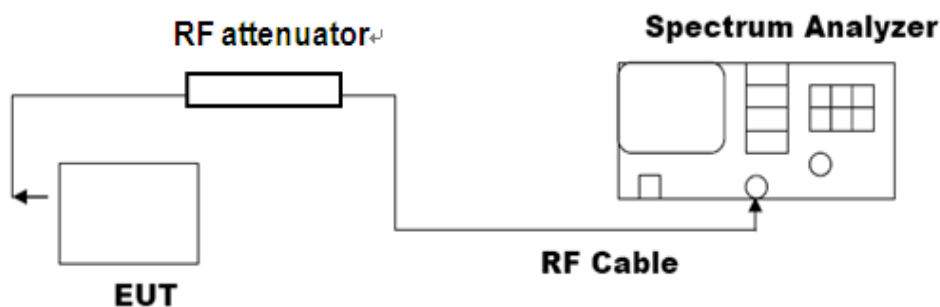

Any report having not been signed by authorized approver, or having been altered without authorization, or having not been stamped by the "Dedicated Testing/Inspection Stamp" is deemed to be invalid. Copying or excerpting portion of, or altering the content of the report is not permitted without the written authorization of AGC. The test results presented in the report apply only to the tested sample. Any objections to report issued by AGC should be submitted to AGC within 15days after the issuance of the test report. Further enquiry of validity or verification of the test report should be addressed to AGC by agc01@agccert.com.

Attestation of Global Compliance(Shenzhen)Co., Ltd

Attestation of Global Compliance(Shenzhen)Std & Tech Co., Ltd

Tel: +86-755 2523 4088 E-mail: agc@agccert.com Web: <http://www.agccert.com/>

5.5.4 TEST RESULT

Test Data of OOB Emissions				
Test Mode	Frequency [MHz]	Level [dBm]	Limit [dBm]	Verdict
BR_HOP_NA_1Mbps	2399.500	-51.94	-10	Pass
	2398.500	-59.64	-20	Pass
	2484.000	-58.41	-10	Pass
	2485.000	-59.73	-20	Pass

Test Graphs of OOB Emissions

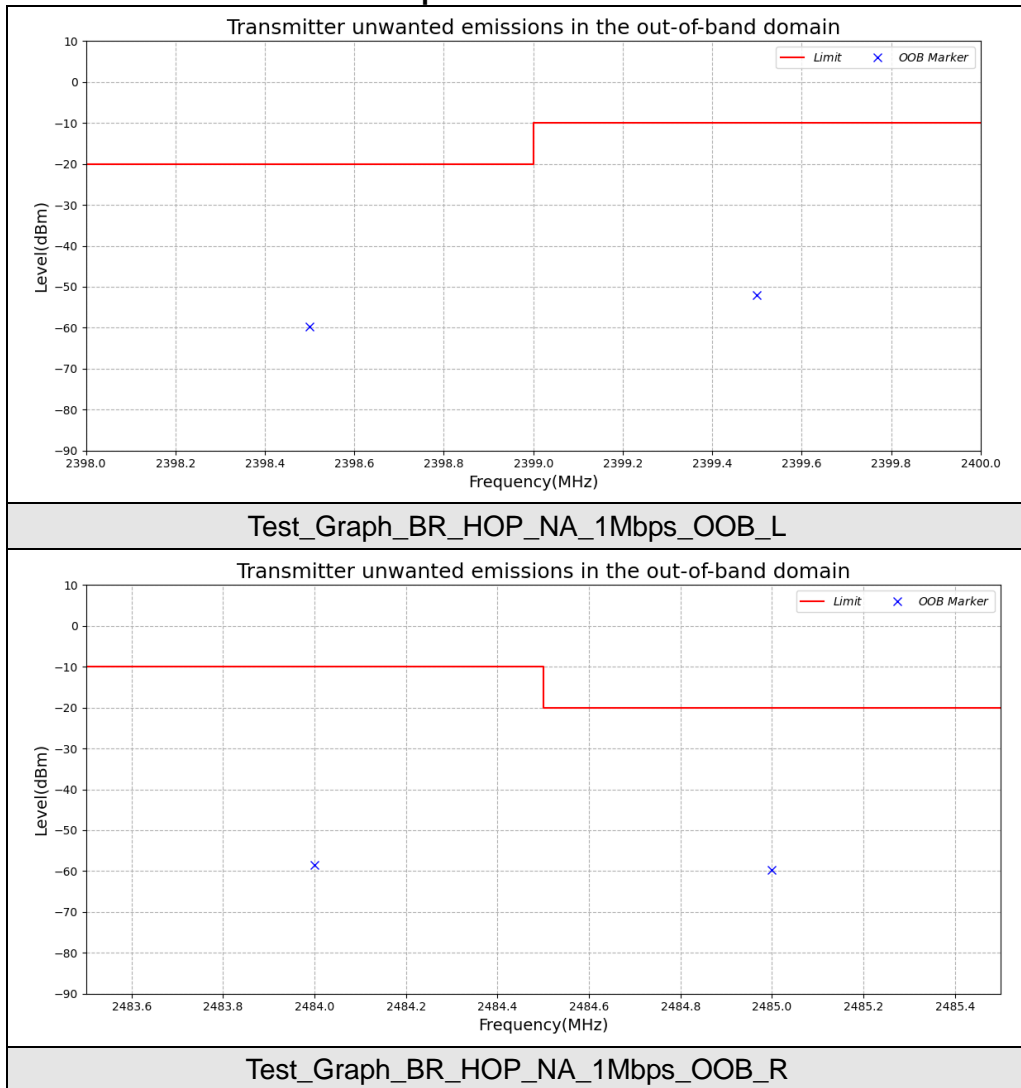

Note: All the modes had been tested, but only the worst data recorded in the report.

Any report having not been signed by authorized approver, or having been altered without authorization, or having not been stamped by the "Dedicated Testing/Inspection Stamp" is deemed to be invalid. Copying or excerpting portion of, or altering the content of the report is not permitted without the written authorization of AGC. The test results presented in the report apply only to the tested sample. Any objections to report issued by AGC should be submitted to AGC within 15days after the issuance of the test report. Further enquiry of validity or verification of the test report should be addressed to AGC by agc01@agccert.com.

5.6. TRANSMITTER SPURIOUS EMISSIONS

5.6.1 LIMIT

The spurious emissions of the transmitter shall not exceed the values in tables in the indicated bands:

Frequency Range	Maximum Power e.r.p(<=1GHz)/e.i.r.p(>1GHz)	Bandwidth
30 MHz to 47 MHz	-36dBm	100kHz
47 MHz to 74 MHz	-54dBm	100kHz
74 MHz to 87.5 MHz	-36dBm	100kHz
87.5 MHz to 118 MHz	-54dBm	100kHz
118 MHz to 174 MHz	-36dBm	100kHz
174 MHz to 230 MHz	-54dBm	100kHz
230 MHz to 470 MHz	-36dBm	100kHz
470 MHz to 694 MHz	-54dBm	100kHz
694 MHz to 1GHz	-36dBm	100kHz
1 GHz to 12.75 GHz	-30dBm	1MHz

Any report having not been signed by authorized approver, or having been altered without authorization, or having not been stamped by the "Dedicated Testing/Inspection Stamp" is deemed to be invalid. Copying or excerpting portion of, or altering the content of the report is not permitted without the written authorization of AGC. The test results presented in the report apply only to the tested sample. Any objections to report issued by AGC should be submitted to AGC within 15days after the issuance of the test report. Further enquiry of validity or verification of the test report should be addressed to AGC by agc01@agccert.com.

5.6.2 TEST PROCEDURE

- 1) The emissions over the range 30 MHz to 1 000 MHz shall be identified.
- 2) Spectrum analyzer settings:
 - Resolution bandwidth: 100 kHz
 - Video bandwidth: 300 kHz
 - Detector mode: Peak
 - Sweep Points: $\geq 19\,400$
 - Trace Mode: Max Hold
- 3) Allow the trace to stabilize. Any emissions identified during the sweeps above and that fall within the 6 dB range below the applicable limit or above, shall be individually measured using RMS detector and compared to the limits.
- 4) The emissions over the range 1 GHz to 12,75 GHz shall be identified.
- 5) Resolution bandwidth: 1 MHz
 - Video bandwidth: 3 MHz
 - Detector mode: Peak
 - Trace Mode: Max Hold
 - Sweep Points: $\geq 23\,500$
- 6) Allow the trace to stabilize. Any emissions identified during the sweeps above and that fall within the 6 dB range below the applicable limit or above, shall be individually measured using RMS detector and compared to the limits.
- 7) For radiated method, the applicable measurement procedures as described in the EN 300 328 V2.2.2 annex C.2 and C.4 are used.

Any report having not been signed by authorized approver, or having been altered without authorization, or having not been stamped by the "Dedicated Testing/Inspection Stamp" is deemed to be invalid. Copying or excerpting portion of, or altering the content of the report is not permitted without the written authorization of AGC. The test results presented in the report apply only to the tested sample. Any objections to report issued by AGC should be submitted to AGC within 15 days after the issuance of the test report. Further enquiry of validity or verification of the test report should be addressed to AGC by agc01@agccert.com.

5.6.3 TEST CONFIGURATION

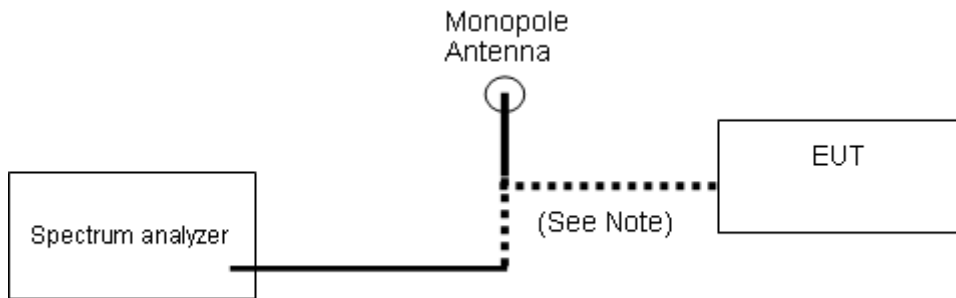

Conducted Method

Below 1GHz

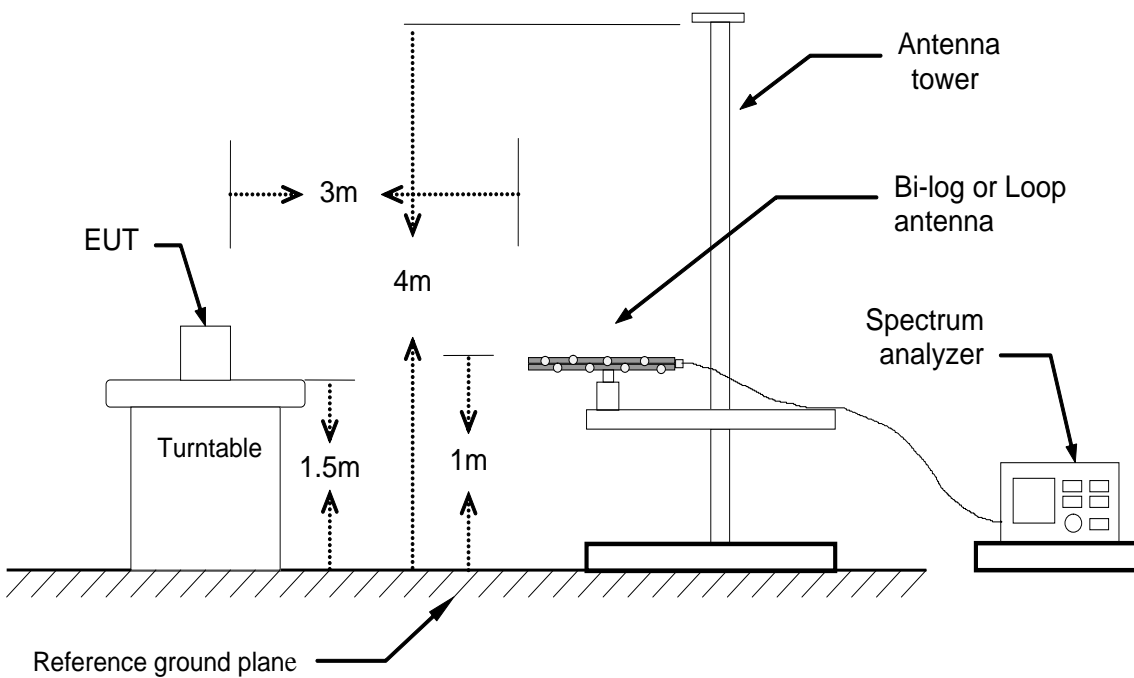

Any report having not been signed by authorized approver, or having been altered without authorization, or having not been stamped by the "Dedicated Testing/Inspection Stamp" is deemed to be invalid. Copying or excerpting portion of, or altering the content of the report is not permitted without the written authorization of AGC. The test results presented in the report apply only to the tested sample. Any objections to report issued by AGC should be submitted to AGC within 15days after the issuance of the test report. Further enquiry of validity or verification of the test report should be addressed to AGC by agc01@agccert.com.

Above 1GHz

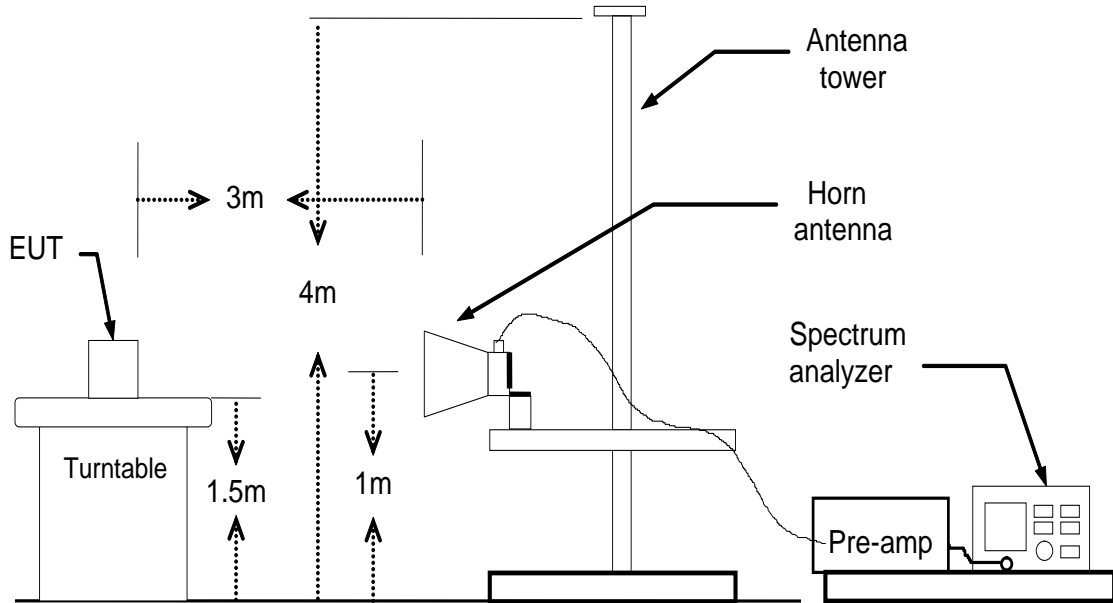

Radiated Method

Any report having not been signed by authorized approver, or having been altered without authorization, or having not been stamped by the "Dedicated Testing/Inspection Stamp" is deemed to be invalid. Copying or excerpting portion of, or altering the content of the report is not permitted without the written authorization of AGC. The test results presented in the report apply only to the tested sample. Any objections to report issued by AGC should be submitted to AGC within 15days after the issuance of the test report. Further enquiry of validity or verification of the test report should be addressed to AGC by agc01@agccert.com.

5.6.4 TEST RESULT

Test Data of Transmitter Spurious Emissions (Conducted Method)					
Test Mode	Detector	Frequency [MHz]	Level [dBm]	Limit [dBm]	Verdict
BR_2402_1Mbps	Peak	796.908	-70.33	-36.00	Pass
	Peak	1900.080	-46.21	-30.00	Pass
BR_2480_1Mbps	Peak	775.567	-70.56	-36.00	Pass
	Peak	4959.882	-45.30	-30.00	Pass

Test Graphs of Transmitter Spurious Emissions (Conducted Method)

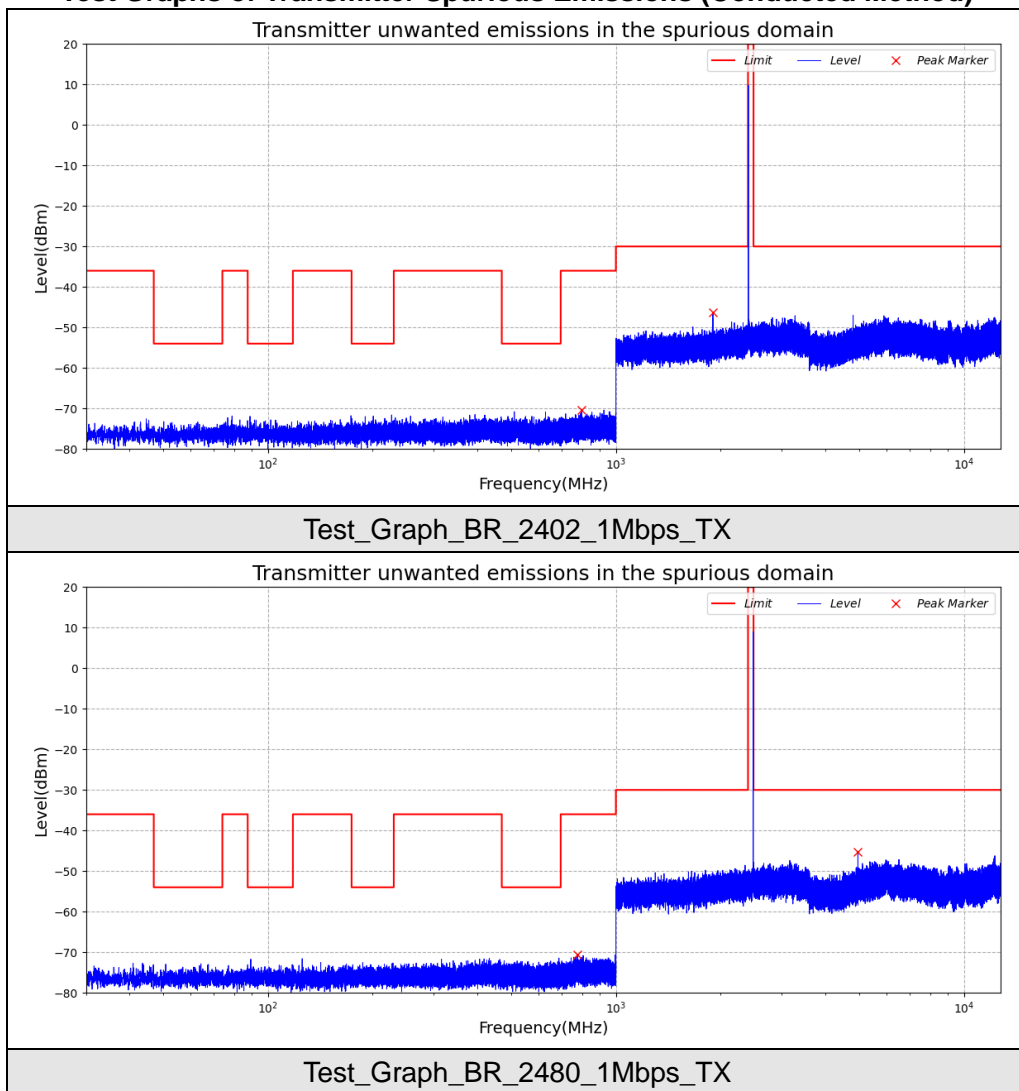

Any report having not been signed by authorized approver, or having been altered without authorization, or having not been stamped by the "Dedicated Testing/Inspection Stamp" is deemed to be invalid. Copying or excerpting portion of, or altering the content of the report is not permitted without the written authorization of AGC. The test results presented in the report apply only to the tested sample. Any objections to report issued by AGC should be submitted to AGC within 15days after the issuance of the test report. Further enquiry of validity or verification of the test report should be addressed to AGC by agc01@agccert.com.

Radiated Method:

(Worst Case: Low channel)

Transmitter Spurious Emission below 1GHz (30MHz-1GHz)

Frequency	Reading Level	Antenna	S.G.	Cable Loss	Ant.Gain	Emission Level	Limit	Margin
(MHz)	(dBuV/m)	Polarization	(dBm)	(dB)	(dBi)	(dBm)	(dBm)	(dB)
85.76	32.65	V	-61.15	0.04	0.70	-60.49	-36.00	24.49
161.78	27.21	V	-67.91	0.06	1.28	-66.69	-36.00	30.69
354.12	30.09	V	-68.58	0.25	6.02	-62.81	-36.00	26.81
428.43	26.67	V	-72.33	0.34	6.94	-65.72	-36.00	29.72
628.82	29.91	V	-69.38	0.51	7.22	-62.68	-54.00	8.68
759.88	28.96	V	-69.28	0.61	6.55	-63.34	-36.00	27.34
Other(30-1000)	--	V	--	--	--	--	-36.00/-54.00	--
112.76	31.62	H	-63.28	0.04	1.40	-61.92	-54.00	7.92
156.04	26.63	H	-67.95	0.06	0.80	-67.21	-36.00	31.21
348.53	28.48	H	-69.46	0.24	5.54	-64.16	-36.00	28.16
433.61	26.74	H	-73.50	0.34	6.69	-67.15	-36.00	31.15
631.60	29.13	H	-70.72	0.52	7.28	-63.96	-54.00	9.96
726.12	28.90	H	-69.32	0.59	6.60	-63.31	-36.00	27.31
Other(30-1000)	--	H	--	--	--	--	-36.00/-54.00	--

Any report having not been signed by authorized approver, or having been altered without authorization, or having not been stamped by the "Dedicated Testing/Inspection Stamp" is deemed to be invalid. Copying or excerpting portion of, or altering the content of the report is not permitted without the written authorization of AGC. The test results presented in the report apply only to the tested sample. Any objections to report issued by AGC should be submitted to AGC within 15days after the issuance of the test report. Further enquiry of validity or verification of the test report should be addressed to AGC by agc01@agccert.com.

Transmitter Spurious Emission above 1GHz (1GHz-12.75GHz)

Frequency	Reading Level	Antenna	S.G.	Cable Loss	Ant.Gain	Emission Level	Limit	Margin
(MHz)	(dBuV/m)	Polarization	(dBm)	(dB)	(dBi)	(dBm)	(dBm)	(dB)
4804	51.84	V	-48.84	2.65	9.34	-42.15	-30.00	12.15
7206	46.43	V	-54.82	3.13	11.32	-46.63	-30.00	16.63
--	--	V	--	--	--	--	--	--
--	--	V	--	--	--	--	--	--
--	--	V	--	--	--	--	--	--
Other(1000-12750)	--	V	--	--	--	--	-30.00	--
4804	51.37	H	-48.68	2.65	9.34	-41.99	-30.00	11.99
7206	44.05	H	-56.86	3.13	11.32	-48.67	-30.00	18.67
--	--	H	--	--	--	--	--	--
--	--	H	--	--	--	--	--	--
--	--	H	--	--	--	--	--	--
Other(1000-12750)	--	H	--	--	--	--	-30.00	--

Note: 1. The margins of the other spectrum are not exceeding the minimum value of margin, and this part of the results without recording in the test report.

2. Measurements above show only up to 6 maximum emissions noted, or would be lesser, with "--" remark, if no specific emission from the EUT are recorded (ie: margin>20dB from the applicable limit) and considered that's already beyond the background noise floor.

(Worst Case: High channel)

Transmitter Spurious Emission below 1GHz (30MHz-1GHz)

Frequency	Reading Level	Antenna	S.G.	Cable Loss	Ant.Gain	Emission Level	Limit	Margin
(MHz)	(dBuV/m)	Polarization	(dBm)	(dB)	(dBi)	(dBm)	(dBm)	(dB)
91.64	31.61	V	-62.06	0.04	1.48	-60.62	-54.00	6.62
161.31	28.84	V	-66.19	0.06	1.28	-64.97	-36.00	28.97
357.93	30.40	V	-69.11	0.25	6.41	-62.96	-36.00	26.96
429.23	26.69	V	-72.66	0.34	6.92	-66.08	-36.00	30.08
627.20	28.19	V	-70.74	0.51	7.18	-64.07	-54.00	10.07
756.10	27.34	V	-71.37	0.61	6.40	-65.57	-36.00	29.57
Other(30-1000)	--	V	--	--	--	--	-36.00/-54.00	--
115.82	30.69	H	-64.23	0.04	1.40	-62.87	-54.00	8.87
151.55	26.10	H	-66.86	0.06	0.70	-66.22	-36.00	30.22
352.73	28.85	H	-70.84	0.25	5.76	-65.33	-36.00	29.33
430.10	26.37	H	-73.19	0.34	6.90	-66.63	-36.00	30.63
630.53	28.74	H	-70.35	0.52	7.30	-63.56	-54.00	9.56
726.80	27.31	H	-71.58	0.59	6.60	-65.56	-36.00	29.56
Other(30-1000)	--	H	--	--	--	--	-36.00/-54.00	--

Any report having not been signed by authorized approver, or having been altered without authorization, or having not been stamped by the "Dedicated Testing/Inspection Stamp" is deemed to be invalid. Copying or excerpting portion of, or altering the content of the report is not permitted without the written authorization of AGC. The test results presented in the report apply only to the tested sample. Any objections to report issued by AGC should be submitted to AGC within 15days after the issuance of the test report. Further enquiry of validity or verification of the test report should be addressed to AGC by agc01@agccert.com.

Transmitter Spurious Emission above 1GHz (1GHz-12.75GHz)

Frequency	Reading Level	Antenna	S.G.	Cable Loss	Ant.Gain	Emission Level	Limit	Margin
(MHz)	(dBuV/m)	Polarization	(dBm)	(dB)	(dBi)	(dBm)	(dBm)	(dB)
4960	51.79	V	-47.68	2.65	9.34	-40.99	-30.00	10.99
7440	47.08	V	-54.76	3.13	11.32	-46.57	-30.00	16.57
--	--	V	--	--	--	--	--	--
--	--	V	--	--	--	--	--	--
--	--	V	--	--	--	--	--	--
Other(1000-12750)	--	V	--	--	--	--	-30.00	--
4960	51.88	H	-48.86	2.65	9.34	-42.17	-30.00	12.17
7440	44.32	H	-56.12	3.13	11.32	-47.93	-30.00	17.93
--	--	H	--	--	--	--	--	--
--	--	H	--	--	--	--	--	--
--	--	H	--	--	--	--	--	--
Other(1000-12750)	--	H	--	--	--	--	-30.00	--

Note: 1. The margins of the other spectrum are not exceeding the minimum value of margin, and this part of the results without recording in the test report.

2. Measurements above show only up to 6 maximum emissions noted, or would be lesser, with "--" remark, if no specific emission from the EUT are recorded (ie: margin>20dB from the applicable limit) and considered that's already beyond the background noise floor.

5.7. RECEIVER SPURIOUS EMISSIONS

5.7.1 LIMIT

Receiver spurious emissions are emissions at any frequency when the equipment is in receive mode. The spurious emissions of the receiver shall not exceed the values given in table.

Frequency Range	Maximum Power e.r.p(<=1GHz)/e.i.r.p(>1GHz)	Measurement Bandwidth
30 MHz to 1000 MHz	-57dBm	100kHz
1 GHz to 12.75 GHz	-47dBm	1MHz

5.7.2 TEST PROCEDURE

- 1)The emissions over the range 30 MHz to 1 000 MHz shall be identified.
- 2)Spectrum analyzer settings:
Resolution bandwidth: 100 kHz
Video bandwidth: 300 kHz
Detector mode: Peak
Sweep Points: ≥19 400
Trace Mode: Max Hold
- 3)Allow the trace to stabilize. Any emissions identified during the sweeps above and that fall within the 6 dB range below the applicable limit or above, shall be individually measured using RMS detector and compared to the limits given in 5.7.1.
- 4) The emissions over the range 1 GHz to 12.75 GHz shall be identified.
- 5) Resolution bandwidth: 1 MHz
Video bandwidth: 3 MHz
Detector mode: Peak
Trace Mode: Max Hold
Sweep Points: ≥23200
- 6) Allow the trace to stabilize. Any emissions identified during the sweeps above and that fall within the 6 dB range below the applicable limit or above, shall be individually measured using RMS detector and compared to the limits given in 5.7.1.
- 7) For radiated method, the applicable measurement procedures as described in the EN 300 328 V2.2.2 annex C.2 and C.4 are used.

5.7.3 TEST CONFIGURATION

Refer to 5.6.3

5.7.4 TEST RESULT

Test Data of Receiver Spurious Emissions (Conducted Method)					
Test Mode	Detector	Frequency [MHz]	Level [dBm]	Limit [dBm]	Verdict
RX_2402_1Mbps	Peak	886.151	-89.18	-57.00	Pass
	Peak	12692.423	-75.07	-47.00	Pass
RX_2480_1Mbps	Peak	425.191	-89.58	-57.00	Pass
	Peak	6047.968	-75.72	-47.00	Pass

Test Graphs of Receiver Spurious Emissions (Conducted Method)

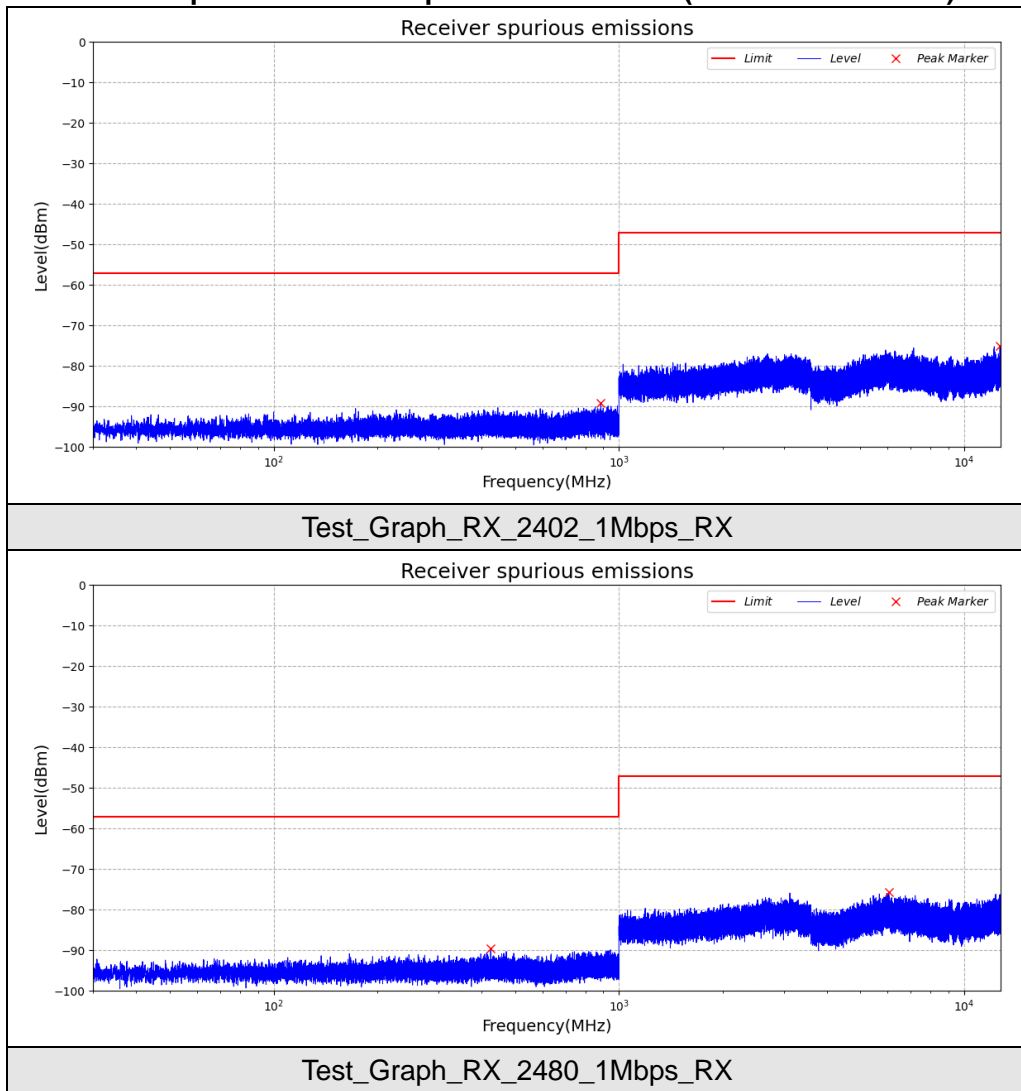

Any report having not been signed by authorized approver, or having been altered without authorization, or having not been stamped by the "Dedicated Testing/Inspection Stamp" is deemed to be invalid. Copying or excerpting portion of, or altering the content of the report is not permitted without the written authorization of AGC. The test results presented in the report apply only to the tested sample. Any objections to report issued by AGC should be submitted to AGC within 15days after the issuance of the test report. Further enquiry of validity or verification of the test report should be addressed to AGC by agc01@agccert.com.

Radiated Method:
(Worst Case: Low channel)

Receiver Spurious Emission below 1GHz (30MHz-1GHz)

Frequency	Reading Level	Antenna	S.G.	Cable Loss	Ant.Gain	Emission Level	Limit	Margin
(MHz)	(dBuV/m)	Polarization	(dBm)	(dB)	(dBi)	(dBm)	(dBm)	(dB)
106.79	27.20	V	-66.88	0.04	0.92	-66.00	-57.00	9.00
159.38	28.84	V	-66.03	0.06	1.10	-64.99	-57.00	7.99
358.46	28.04	V	-71.26	0.25	6.54	-64.97	-57.00	7.97
535.19	26.55	V	-72.36	0.45	6.90	-65.91	-57.00	8.91
676.56	30.57	V	-69.44	0.55	6.56	-63.43	-57.00	6.43
833.66	30.09	V	-68.10	0.66	6.51	-62.25	-57.00	5.25
Other(30-1000)	--	V	--	--	--	--	-57.00	--
142.24	28.99	H	-63.97	0.05	0.12	-63.90	-57.00	6.90
161.99	29.74	H	-64.98	0.06	1.28	-63.76	-57.00	6.76
341.33	29.10	H	-70.07	0.23	5.68	-64.62	-57.00	7.62
538.20	28.35	H	-71.34	0.45	7.08	-64.71	-57.00	7.71
677.87	29.21	H	-69.52	0.55	6.52	-63.55	-57.00	6.55
831.59	27.62	H	-71.11	0.66	6.37	-65.40	-57.00	8.40
Other(30-1000)	--	H	--	--	--	--	-57.00	--

Any report having not been signed by authorized approver, or having been altered without authorization, or having not been stamped by the "Dedicated Testing/Inspection Stamp" is deemed to be invalid. Copying or excerpting portion of, or altering the content of the report is not permitted without the written authorization of AGC. The test results presented in the report apply only to the tested sample. Any objections to report issued by AGC should be submitted to AGC within 15days after the issuance of the test report. Further enquiry of validity or verification of the test report should be addressed to AGC by agc01@agccert.com.

Receiver Spurious Emission above 1GHz (1GHz-12.75GHz)

Frequency	Reading Level	Antenna	S.G.	Cable Loss	Ant.Gain	Emission Level	Limit	Margin
(MHz)	(dBuV/m)	Polarization	(dBm)	(dB)	(dBi)	(dBm)	(dBm)	(dB)
1746.01	32.05	V	-66.86	1.22	6.84	-61.24	-47.00	14.24
--	--	V	--	--	--	--	--	--
--	--	V	--	--	--	--	--	--
--	--	V	--	--	--	--	--	--
--	--	V	--	--	--	--	--	--
Other(1000-12750)	--	V	--	--	--	--	-47.00	--
1678.11	32.15	H	-68.01	1.19	6.67	-62.53	-47.00	15.53
--	--	H	--	--	--	--	--	--
--	--	H	--	--	--	--	--	--
--	--	H	--	--	--	--	--	--
--	--	H	--	--	--	--	--	--
Other(1000-12750)	--	H	--	--	--	--	-47.00	--

Note: 1. The margins of the other spectrum are not exceeding the minimum value of margin, and this part of the results without recording in the test report.

2. Measurements above show only up to 6 maximum emissions noted, or would be lesser, with "--" remark, if no specific emission from the EUT are recorded (ie: margin>20dB from the applicable limit) and considered that's already beyond the background noise floor.

Any report having not been signed by authorized approver, or having been altered without authorization, or having not been stamped by the "Dedicated Testing/Inspection Stamp" is deemed to be invalid. Copying or excerpting portion of, or altering the content of the report is not permitted without the written authorization of AGC. The test results presented in the report apply only to the tested sample. Any objections to report issued by AGC should be submitted to AGC within 15days after the issuance of the test report. Further enquiry of validity or verification of the test report should be addressed to AGC by agc01@agccert.com.

(Worst Case: High channel)

Receiver Spurious Emission below 1GHz (30MHz-1GHz)

Frequency	Reading Level	Antenna	S.G.	Cable Loss	Ant.Gain	Emission Level	Limit	Margin
(MHz)	(dBuV/m)	Polarization	(dBm)	(dB)	(dBi)	(dBm)	(dBm)	(dB)
110.67	26.32	V	-68.84	0.04	1.40	-67.48	-57.00	10.48
159.85	29.85	V	-63.45	0.06	1.10	-62.41	-57.00	5.41
357.16	28.30	V	-71.79	0.25	6.41	-65.63	-57.00	8.63
532.94	27.06	V	-72.55	0.44	6.72	-66.28	-57.00	9.28
673.65	31.08	V	-69.05	0.55	6.68	-62.92	-57.00	5.92
829.94	29.19	V	-69.89	0.66	6.35	-64.20	-57.00	7.20
Other(30-1000)	--	V	--	--	--	--	-57.00	--
146.64	28.82	H	-64.38	0.05	0.38	-64.05	-57.00	7.05
160.18	28.07	H	-67.23	0.06	1.20	-66.09	-57.00	9.09
343.68	30.19	H	-69.12	0.24	5.64	-63.72	-57.00	6.72
541.60	27.21	H	-71.89	0.45	7.15	-65.19	-57.00	8.19
676.89	28.90	H	-71.09	0.55	6.56	-65.08	-57.00	8.08
831.30	28.15	H	-71.17	0.66	6.37	-65.46	-57.00	8.46
Other(30-1000)	--	H	--	--	--	--	-57.00	--

Any report having not been signed by authorized approver, or having been altered without authorization, or having not been stamped by the "Dedicated Testing/Inspection Stamp" is deemed to be invalid. Copying or excerpting portion of, or altering the content of the report is not permitted without the written authorization of AGC. The test results presented in the report apply only to the tested sample. Any objections to report issued by AGC should be submitted to AGC within 15days after the issuance of the test report. Further enquiry of validity or verification of the test report should be addressed to AGC by agc01@agccert.com.

Receiver Spurious Emission above 1GHz (1GHz-12.75GHz)

Frequency	Reading Level	Antenna	S.G.	Cable Loss	Ant.Gain	Emission Level	Limit	Margin
(MHz)	(dBuV/m)	Polarization	(dBm)	(dB)	(dBi)	(dBm)	(dBm)	(dB)
1809.45	31.46	V	-68.47	1.22	6.84	-62.85	-47.00	15.85
--	--	V	--	--	--	--	--	--
--	--	V	--	--	--	--	--	--
--	--	V	--	--	--	--	--	--
--	--	V	--	--	--	--	--	--
Other(1000-12750)	--	V	--	--	--	--	-47.00	--
1683.04	33.39	H	-66.48	1.19	6.67	-61.00	-47.00	14.00
--	--	H	--	--	--	--	--	--
--	--	H	--	--	--	--	--	--
--	--	H	--	--	--	--	--	--
--	--	H	--	--	--	--	--	--
Other(1000-12750)	--	H	--	--	--	--	-47.00	--

Note: 1. The margins of the other spectrum are not exceeding the minimum value of margin, and this part of the results without recording in the test report.

2. Measurements above show only up to 6 maximum emissions noted, or would be lesser, with "--" remark, if no specific emission from the EUT are recorded (ie: margin>20dB from the applicable limit) and considered that's already beyond the background noise floor.

5.8. RECEIVER BLOCKING

5.8.1 LIMIT

Receiver Blocking parameters for Receiver Category 1 equipment

Wanted signal mean power from companion device (dBm) (see notes 1 and 4)	Blocking signal frequency (MHz)	Blocking signal power (dBm) (see note 4)	Type of blocking signal
(-133 dBm + 10 × log ₁₀ (OCBW)) or -68 dBm whichever is less (see note 2)	2 380	-34	CW
	2 504		
(-139 dBm + 10 × log ₁₀ (OCBW)) or -74 dBm whichever is less (see note 3)	2 300		
	2 330		
	2 360		
	2 524		
	2 584		
	2 674		

NOTE 1: OCBW is in Hz.

NOTE 2: In case of radiated measurements using a companion device and the level of the wanted signal from the companion device cannot be determined, a relative test may be performed using a wanted signal up to $P_{min} + 26$ dB where P_{min} is the minimum level of wanted signal required to meet the minimum performance criteria as defined in clause 4.3.1.12.3 in the absence of any blocking signal.

NOTE 3: In case of radiated measurements using a companion device and the level of the wanted signal from the companion device cannot be determined, a relative test may be performed using a wanted signal up to $P_{min} + 20$ dB where P_{min} is the minimum level of wanted signal required to meet the minimum performance criteria as defined in clause 4.3.1.12.3 in the absence of any blocking signal.

NOTE 4: The level specified is the level at the UUT receiver input assuming a 0 dBi antenna assembly gain. In case of conducted measurements, this level has to be corrected for the (in-band) antenna assembly gain (G). In case of radiated measurements, this level is equivalent to a power flux density (PFD) in front of the UUT antenna with the UUT being configured/positioned as recorded in clause 5.4.3.2.2.

Receiver Blocking parameters for Receiver Category 2 equipment

Wanted signal mean power from companion device (dBm) (see notes 1 and 3)	Blocking signal frequency (MHz)	Blocking signal power (dBm) (see note 3)	Type of blocking signal
(-139 dBm + 10 × log ₁₀ (OCBW) + 10 dB) or (-74 dBm + 10 dB) whichever is less (see note 2)	2 380	-34	CW
	2 504		
	2 300		
	2 584		

NOTE 1: OCBW is in Hz.

NOTE 2: In case of radiated measurements using a companion device and the level of the wanted signal from the companion device cannot be determined, a relative test may be performed using a wanted signal up to $P_{min} + 26$ dB where P_{min} is the minimum level of wanted signal required to meet the minimum performance criteria as defined in clause 4.3.1.12.3 in the absence of any blocking signal.

NOTE 3: The level specified is the level at the UUT receiver input assuming a 0 dBi antenna assembly gain. In case of conducted measurements, this level has to be corrected for the (in-band) antenna assembly gain (G). In case of radiated measurements, this level is equivalent to a power flux density (PFD) in front of the UUT antenna with the UUT being configured/positioned as recorded in clause 5.4.3.2.2.

Receiver Blocking parameters for Receiver Category 3 equipment

Wanted signal mean power from companion device (dBm) (see notes 1 and 3)	Blocking signal frequency (MHz)	Blocking signal power (dBm) (see note 3)	Type of blocking signal
(-139 dBm + 10 × log ₁₀ (OCBW) + 20 dB) or (-74 dBm + 20 dB) whichever is less (see note 2)	2 380	-34	CW
	2 504		
	2 300		
	2 584		

NOTE 1: OCBW is in Hz.

NOTE 2: In case of radiated measurements using a companion device and the level of the wanted signal from the companion device cannot be determined, a relative test may be performed using a wanted signal up to $P_{min} + 30$ dB where P_{min} is the minimum level of wanted signal required to meet the minimum performance criteria as defined in clause 4.3.1.12.3 in the absence of any blocking signal.

NOTE 3: The level specified is the level at the UUT receiver input assuming a 0 dBi antenna assembly gain. In case of conducted measurements, this level has to be corrected for the (in-band) antenna assembly gain (G). In case of radiated measurements, this level is equivalent to a power flux density (PFD) in front of the UUT antenna with the UUT being configured/positioned as recorded in clause 5.4.3.2.2.

5.8.2 TEST PROCEDURE

For non-FHSS equipment, having more than one operating channel, the operating channels on which the testing has to be performed shall be selected as follows:

- For testing blocking frequencies less than 2 400 MHz, the equipment shall operate on the lowest operating channel.
- For testing blocking frequencies greater than 2 500 MHz, the equipment shall operate on the highest operating channel.

The simplified conducted measure procedures are as follows:

- 1) For non-FHSS equipment, the UUT shall be set to the lowest operating channel on which the blocking test has to be performed.
- 2) The blocking signal generator is set to the first frequency as defined in the appropriate table corresponding to the receiver category and type of equipment.
- 3) With the blocking signal generator switched off, a communication link is established between the UUT and the associated companion device using the test setup. The level of the wanted signal shall be set to the value provided in the table corresponding to the receiver category and type of equipment. This level may be measured directly at the output of the companion device and a correction is made for the coupling loss into the UUT. The actual level for the wanted signal shall be recorded in the test report.
- 4) The blocking signal at the UUT is set to the level provided in the table corresponding to the receiver category and type of equipment. It shall be verified and recorded in the test report that the performance criteria is met.
- 5) Repeat step 4 for each remaining combination of frequency and level for the blocking signal as provided in the table corresponding to the receiver category and type of equipment.
- 6) Repeat step 2 to step 5 with the UUT operating at the highest operating channel.

5.8.3 TEST CONFIGURATION

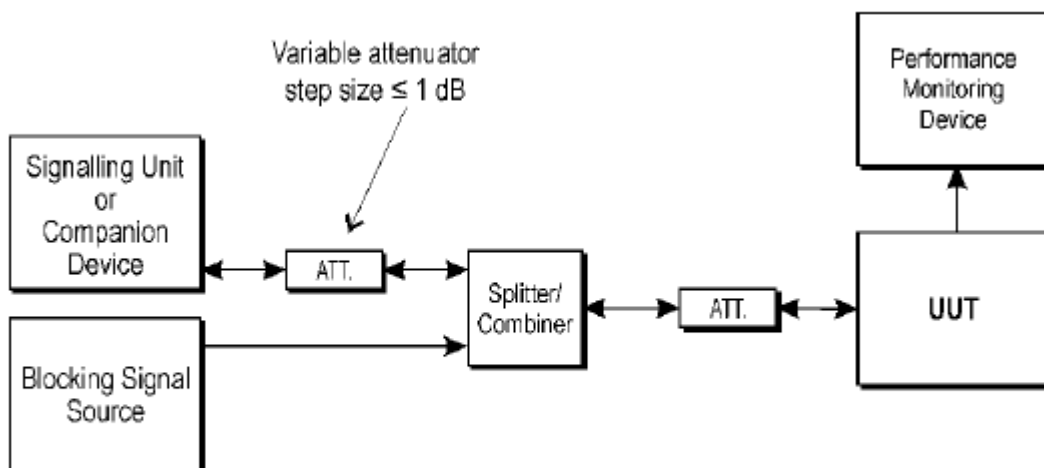

Test Set-up for receiver blocking

Any report having not been signed by authorized approver, or having been altered without authorization, or having not been stamped by the “Dedicated Testing/Inspection Stamp” is deemed to be invalid. Copying or excerpting portion of, or altering the content of the report is not permitted without the written authorization of AGC. The test results presented in the report apply only to the tested sample. Any objections to report issued by AGC should be submitted to AGC within 15days after the issuance of the test report. Further enquiry of validity or verification of the test report should be addressed to AGC by agc01@agccert.com.

5.8.4 TEST RESULTS

Test Data of Receiver Blocking						
Test Condition	Blocking Signal Frequency (MHz)	Blocking Signal Power(dBm)	Wanted signal mean power from companion device(dBm)	Performance PER(%)	Limit PER(%)	Result
GFSK Hopping Mode	2300	-30.00	-55.38	1.03%	10%	Pass
	2380	-30.00	-55.38	0.72%	10%	Pass
	2504	-30.00	-55.44	2.67%	10%	Pass
	2584	-30.00	-55.44	1.68%	10%	Pass

Test Data of Receiver Blocking						
Test Condition	Blocking Signal Frequency (MHz)	Blocking Signal Power(dBm)	Wanted signal mean power from companion device(dBm)	Performance PER(%)	Limit PER(%)	Result
π /4-DQPSK Hopping Mode	2300	-30.00	-54.21	1.48%	10%	Pass
	2380	-30.00	-54.21	2.38%	10%	Pass
	2504	-30.00	-54.24	1.21%	10%	Pass
	2584	-30.00	-54.24	2.03%	10%	Pass

Test Data of Receiver Blocking						
Test Condition	Blocking Signal Frequency (MHz)	Blocking Signal Power(dBm)	Wanted signal mean power from companion device(dBm)	Performance PER(%)	Limit PER(%)	Result
8DPSK Hopping Mode	2300	-30.00	-54.17	1.39%	10%	Pass
	2380	-30.00	-54.17	1.09%	10%	Pass
	2504	-30.00	-54.20	2.71%	10%	Pass
	2584	-30.00	-54.20	1.74%	10%	Pass

Note: The levels of the blocking signal and wanted signal have to be corrected for the (in-band) antenna assembly gain.

APPENDIX A: PHOTOGRAPHS OF THE TEST SETUP

RADIATED SPURIOUS EMISSION TEST SETUP



RADIATED SPURIOUS EMISSION ABOVE 1G TEST SETUP



Any report having not been signed by authorized approver, or having been altered without authorization, or having not been stamped by the “Dedicated Testing/Inspection Stamp” is deemed to be invalid. Copying or excerpting portion of, or altering the content of the report is not permitted without the written authorization of AGC. The test results presented in the report apply only to the tested sample. Any objections to report issued by AGC should be submitted to AGC within 15days after the issuance of the test report. Further enquiry of validity or verification of the test report should be addressed to AGC by agc01@agccert.com.

Attestation of Global Compliance(Shenzhen)Co., Ltd

Attestation of Global Compliance(Shenzhen)Std & Tech Co., Ltd

Tel: +86-755 2523 4088 E-mail: agc@agccert.com Web: <http://www.agccert.com/>

RF CONDUCTED TEST SETUP

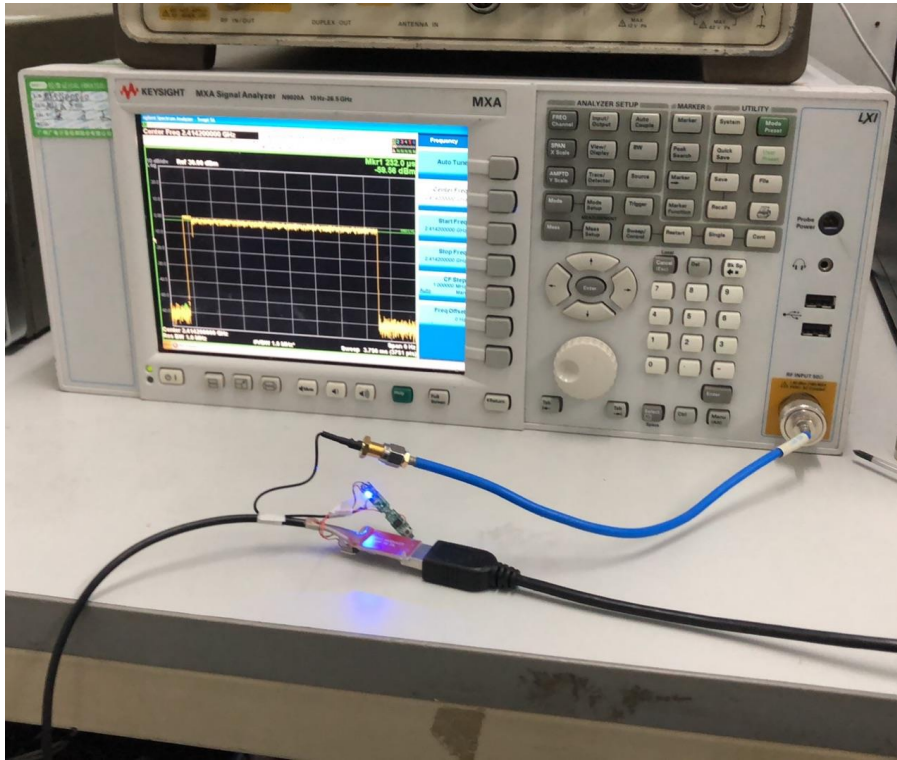

Any report having not been signed by authorized approver, or having been altered without authorization, or having not been stamped by the “Dedicated Testing/Inspection Stamp” is deemed to be invalid. Copying or excerpting portion of, or altering the content of the report is not permitted without the written authorization of AGC. The test results presented in the report apply only to the tested sample. Any objections to report issued by AGC should be submitted to AGC within 15days after the issuance of the test report. Further enquiry of validity or verification of the test report should be addressed to AGC by agc01@agccert.com.

Attestation of Global Compliance(Shenzhen)Co., Ltd
Attestation of Global Compliance(Shenzhen)Std & Tech Co., Ltd
Tel: +86-755 2523 4088 E-mail: agc@agccert.com Web: <http://www.agccert.com/>

APPENDIX B: PHOTOGRAPHS OF EUT

Refer to the Report No.: AGC05443220333AP01

----END OF REPORT----

Any report having not been signed by authorized approver, or having been altered without authorization, or having not been stamped by the "Dedicated Testing/Inspection Stamp" is deemed to be invalid. Copying or excerpting portion of, or altering the content of the report is not permitted without the written authorization of AGC. The test results presented in the report apply only to the tested sample. Any objections to report issued by AGC should be submitted to AGC within 15days after the issuance of the test report. Further enquiry of validity or verification of the test report should be addressed to AGC by agc01@agccert.com.

Attestation of Global Compliance(Shenzhen)Co., Ltd

Attestation of Global Compliance(Shenzhen)Std & Tech Co., Ltd

Tel: +86-755 2523 4088 E-mail: agc@agccert.com Web: <http://www.agccert.com/>



Conditions of Issuance of Test Reports

1. All samples and goods are accepted by the Attestation of Global Compliance (Shenzhen) Co., Ltd (the “Company”) solely for testing and reporting in accordance with the following terms and conditions. The company provides its services on the basis that such terms and conditions constitute express agreement between the company and any person, firm or company requesting its services (the “Clients”).
2. Any report issued by Company as a result of this application for testing services (the “Report”) shall be issued in confidence to the Clients and the Report will be strictly treated as such by the Company. It may not be reproduced either in its entirety or in part and it may not be used for advertising or other unauthorized purposes without the written consent of the Company. The Clients to whom the Report is issued may, however, show or send it, or a certified copy thereof prepared by the Company to its customer, supplier or other persons directly concerned. The Company will not, without the consent of the Clients, enter into any discussion or correspondence with any third party concerning the contents of the Report, unless required by the relevant governmental authorities, laws or court orders.
3. The Company shall not be called or be liable to be called to give evidence or testimony on the Report in a court of law without its prior written consent, unless required by the relevant governmental authorities, laws or court orders.
4. In the event of the improper use of the report as determined by the Company, the Company reserves the right to withdraw it, and to adopt any other additional remedies which may be appropriate.
5. Samples submitted for testing are accepted on the understanding that the Report issued cannot form the basis of, or be the instrument for, any legal action against the Company.
6. The Company will not be liable for or accept responsibility for any loss or damage however arising from the use of information contained in any of its Reports or in any communication whatsoever about its said tests or investigations.
7. Clients wishing to use the Report in court proceedings or arbitration shall inform the Company to that effect prior to submitting the sample for testing.
8. The Company is not responsible for recalling the electronic version of the original report when any revision is made to them. The Client assumes the responsibility to providing the revised version to any interested party who uses them.
9. Subject to the variable length of retention time for test data and report stored hereinto as otherwise specifically required by individual accreditation authorities, the Company will only keep the supporting test data and information of the test report for a period of six years. The data and information will be disposed of after the aforementioned retention period has elapsed. Under no circumstances shall we provide any data and information which has been disposed of after retention period. Under no circumstances shall we be liable for damage of any kind, including (but not limited to) compensatory damages, lost profits, lost data, or any form of special, incidental, indirect, consequential or punitive damages of any kind, whether based on breach of contract of warranty, tort (including negligence), product liability or otherwise, even if we are informed in advance of the possibility of such damages.

Any report having not been signed by authorized approver, or having been altered without authorization, or having not been stamped by the “Dedicated Testing/Inspection Stamp” is deemed to be invalid. Copying or excerpting portion of, or altering the content of the report is not permitted without the written authorization of AGC. The test results presented in the report apply only to the tested sample. Any objections to report issued by AGC should be submitted to AGC within 15 days after the issuance of the test report. Further enquiry of validity or verification of the test report should be addressed to AGC by agc01@agccert.com.

Health Test Report

Report No.: AGC05443220333EH02

PRODUCT DESIGNATION : Wireless charging earbuds
BRAND NAME : N/A
MODEL NAME : M09768
APPLICANT : MID OCEAN BRANDS B.V
DATE OF ISSUE : Apr. 14, 2022
STANDARD(S) : EN 62479:2010
: EN 50663:2017
REPORT VERSION : V1.0



Attestation of Global Compliance (Shenzhen) Co., Ltd.



Any report having not been signed by authorized approver, or having been altered without authorization, or having not been stamped by the "Dedicated Testing/Inspection Stamp" is deemed to be invalid. Copying or excerpting portion of, or altering the content of the report is not permitted without the written authorization of AGC. The test results presented in the report apply only to the tested sample. Any objections to report issued by AGC should be submitted to AGC within 15days after the issuance of the test report. Further enquiry of validity or verification of the test report should be addressed to AGC by agc01@agccert.com.

REPORT REVISE RECORD

Report Version	Revise Time	Issued Date	Valid Version	Notes
V1.0	/	Apr. 14, 2022	Valid	Initial release

Any report having not been signed by authorized approver, or having been altered without authorization, or having not been stamped by the "Dedicated Testing/Inspection Stamp" is deemed to be invalid. Copying or excerpting portion of, or altering the content of the report is not permitted without the written authorization of AGC. The test results presented in the report apply only to the tested sample. Any objections to report issued by AGC should be submitted to AGC within 15days after the issuance of the test report. Further enquiry of validity or verification of the test report should be addressed to AGC by agc01@agccert.com.

TABLE OF CONTENTS

1. GENERAL INFORMATION	4
2. TECHNICAL INFORMATION	5
3. TEST RESULT	6
4. CONCLUSION	6

Any report having not been signed by authorized approver, or having been altered without authorization, or having not been stamped by the “Dedicated Testing/Inspection Stamp” is deemed to be invalid. Copying or excerpting portion of, or altering the content of the report is not permitted without the written authorization of AGC. The test results presented in the report apply only to the tested sample. Any objections to report issued by AGC should be submitted to AGC within 15days after the issuance of the test report. Further enquiry of validity or verification of the test report should be addressed to AGC by agc01@agccert.com.

1. GENERAL INFORMATION

Applicant	MID OCEAN BRANDS B.V
Address	7/F, Kings Tower, 111 King Lam Street, Cheung Sha Wan, Kowloon, Hong Kong
Manufacturer	MID OCEAN BRANDS B.V
Address	7/F, Kings Tower, 111 King Lam Street, Cheung Sha Wan, Kowloon, Hong Kong
Factory	MID OCEAN BRANDS B.V
Address	7/F, Kings Tower, 111 King Lam Street, Cheung Sha Wan, Kowloon, Hong Kong
Product Designation	Wireless charging earbuds
Brand Name	N/A
Test Model	MO9768
Date of test	Mar. 31, 2022 to Apr. 12, 2022
Test Result	Pass

We (AGC), Attestation of Global Compliance (Shenzhen) Co., Ltd. for compliance with the requirements set forth in the European Standard EN 62479:2010. The results of testing in this report apply to the product/system which was tested only.

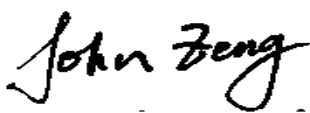
Prepared By 

 John Zeng
 (Project Engineer) Apr. 14, 2022

Reviewed By 

 Calvin Liu
 (Reviewer) Apr. 14, 2022

Approved By 

 Max Zhang
 (Authorized Officer) Apr. 14, 2022

Any report having not been signed by authorized approver, or having been altered without authorization, or having not been stamped by the "Dedicated Testing/Inspection Stamp" is deemed to be invalid. Copying or excerpting portion of, or altering the content of the report is not permitted without the written authorization of AGC. The test results presented in the report apply only to the tested sample. Any objections to report issued by AGC should be submitted to AGC within 15days after the issuance of the test report. Further enquiry of validity or verification of the test report should be addressed to AGC by agc01@agccert.com.

2. TECHNICAL INFORMATION

Note: the following data is based on the information by the applicant.

Product Designation	Wireless charging earbuds
Brand Name	N/A
Test Model	MO9768
Hardware Version	Bluetooth-AF0031 V1.0
Software Version	leader.1910.01 V5.0
Operating Frequency	2.402GHz to 2.480GHz
Bluetooth Version	V5.0
Modulation type	BR <input checked="" type="checkbox"/> GFSK_1Mbps; EDR <input checked="" type="checkbox"/> π/4-DQPSK_2Mbps <input checked="" type="checkbox"/> 8DPSK_3Mbps BLE <input type="checkbox"/> GFSK 1Mbps <input type="checkbox"/> GFSK 2Mbps
Number of Channels	79 Channels
Antenna Type	Ceramic Antenna
Antenna gain	4dBi
Power Supply (Headset)	DC 3.7V by battery
Power Supply(Charging dock)	DC 3.7V by battery or DC 5V by adapter

Note: For more details, please refer to the user's manual of the EUT.

3. TEST RESULT

The maximum output power of Bluetooth is **-0.38dBm (0.91mW which is less than 20mW)**. Please refer to ETSI EN 300 328 (V2.2.2) Test report (AGC05443220333EE04) for the result of Maximum Transmit Power, which deemed to comply with the basic restrictions without testing.

4. CONCLUSION

Remark: EUT meets the basic requirements in the standard.



Conditions of Issuance of Test Reports

1. All samples and goods are accepted by the Attestation of Global Compliance (Shenzhen) Co., Ltd (the “Company”) solely for testing and reporting in accordance with the following terms and conditions. The company provides its services on the basis that such terms and conditions constitute express agreement between the company and any person, firm or company requesting its services (the “Clients”).
2. Any report issued by Company as a result of this application for testing services (the “Report”) shall be issued in confidence to the Clients and the Report will be strictly treated as such by the Company. It may not be reproduced either in its entirety or in part and it may not be used for advertising or other unauthorized purposes without the written consent of the Company. The Clients to whom the Report is issued may, however, show or send it, or a certified copy thereof prepared by the Company to its customer, supplier or other persons directly concerned. The Company will not, without the consent of the Clients, enter into any discussion or correspondence with any third party concerning the contents of the Report, unless required by the relevant governmental authorities, laws or court orders.
3. The Company shall not be called or be liable to be called to give evidence or testimony on the Report in a court of law without its prior written consent, unless required by the relevant governmental authorities, laws or court orders.
4. In the event of the improper use of the report as determined by the Company, the Company reserves the right to withdraw it, and to adopt any other additional remedies which may be appropriate.
5. Samples submitted for testing are accepted on the understanding that the Report issued cannot form the basis of, or be the instrument for, any legal action against the Company.
6. The Company will not be liable for or accept responsibility for any loss or damage however arising from the use of information contained in any of its Reports or in any communication whatsoever about its said tests or investigations.
7. Clients wishing to use the Report in court proceedings or arbitration shall inform the Company to that effect prior to submitting the sample for testing.
8. The Company is not responsible for recalling the electronic version of the original report when any revision is made to them. The Client assumes the responsibility to providing the revised version to any interested party who uses them.
9. Subject to the variable length of retention time for test data and report stored hereinto as otherwise specifically required by individual accreditation authorities, the Company will only keep the supporting test data and information of the test report for a period of six years. The data and information will be disposed of after the aforementioned retention period has elapsed. Under no circumstances shall we provide any data and information which has been disposed of after retention period. Under no circumstances shall we be liable for damage of any kind, including (but not limited to) compensatory damages, lost profits, lost data, or any form of special, incidental, indirect, consequential or punitive damages of any kind, whether based on breach of contract of warranty, tort (including negligence), product liability or otherwise, even if we are informed in advance of the possibility of such damages.

Any report having not been signed by authorized approver, or having been altered without authorization, or having not been stamped by the “Dedicated Testing/Inspection Stamp” is deemed to be invalid. Copying or excerpting portion of, or altering the content of the report is not permitted without the written authorization of AGC. The test results presented in the report apply only to the tested sample. Any objections to report issued by AGC should be submitted to AGC within 15 days after the issuance of the test report. Further enquiry of validity or verification of the test report should be addressed to AGC by agc01@agccert.com.

RF Test Report

Report No.: AGC05443220333EE17

PRODUCT DESIGNATION : Wireless charging earbuds
BRAND NAME : N/A
MODEL NAME : M09768
APPLICANT : MID OCEAN BRANDS B.V
DATE OF ISSUE : Apr. 14, 2022
STANDARD(S) : ETSI EN 303 417 V1.1.1(2017-09)
REPORT VERSION : V1.0

Attestation of Global Compliance (Shenzhen) Co., Ltd.



Any report having not been signed by authorized approver, or having been altered without authorization, or having not been stamped by the "Dedicated Testing/Inspection Stamp" is deemed to be invalid. Copying or excerpting portion of, or altering the content of the report is not permitted without the written authorization of AGC. The test results presented in the report apply only to the tested sample. Any objections to report issued by AGC should be submitted to AGC within 15days after the issuance of the test report. Further enquiry of validity or verification of the test report should be addressed to AGC by agc01@agccert.com.

REPORT REVISE RECORD

Report Version	Revise Time	Issued Date	Valid Version	Notes
V1.0	/	Apr. 14, 2022	Valid	Initial Release

Any report having not been signed by authorized approver, or having been altered without authorization, or having not been stamped by the "Dedicated Testing/Inspection Stamp" is deemed to be invalid. Copying or excerpting portion of, or altering the content of the report is not permitted without the written authorization of AGC. The test results presented in the report apply only to the tested sample. Any objections to report issued by AGC should be submitted to AGC within 15days after the issuance of the test report. Further enquiry of validity or verification of the test report should be addressed to AGC by agc01@agccert.com.

TABLE OF CONTENTS

1. TEST RESULT CERTIFICATION	4
2. EUT DESCRIPTION	5
3. DESCRIPTION OF TEST ITEMS	6
4. TEST FACILITY	6
5. ETSI EN 303 417 REQUIREMENT	7
5.1 TRANSMITTER H-FIELD REQUIREMENTS	7
5.2 OPERATING FREQUENCY RANGES	11
5.3 TRANSMITTER OUT OF BAND (OOB) EMISSIONS	13
5.4 TRANSMITTER SPURIOUS EMISSIONS	16
5.5 RECEIVER BLOCKING	23
6. INTERPRETATION OF MEASUREMENT RESULTS.....	25
APPENDIX A: PHOTOGRAPHS OF TEST SETUP	26
APPENDIX B: PHOTOGRAPHS OF THE EUT	27

Any report having not been signed by authorized approver, or having been altered without authorization, or having not been stamped by the "Dedicated Testing/Inspection Stamp" is deemed to be invalid. Copying or excerpting portion of, or altering the content of the report is not permitted without the written authorization of AGC. The test results presented in the report apply only to the tested sample. Any objections to report issued by AGC should be submitted to AGC within 15days after the issuance of the test report. Further enquiry of validity or verification of the test report should be addressed to AGC by agc01@agccert.com.

1. TEST RESULT CERTIFICATION

Applicant	MID OCEAN BRANDS B.V
Address	7/F, Kings Tower, 111 King Lam Street, Cheung Sha Wan, Kowloon, Hong Kong
Manufacturer	MID OCEAN BRANDS B.V
Address	7/F, Kings Tower, 111 King Lam Street, Cheung Sha Wan, Kowloon, Hong Kong
Factory	MID OCEAN BRANDS B.V
Address	7/F, Kings Tower, 111 King Lam Street, Cheung Sha Wan, Kowloon, Hong Kong
Product Designation	Wireless charging earbuds
Brand Name	N/A
Test Model	MO9768
Date of test	Mar. 31, 2022 to Apr. 12, 2022
Deviation	None
Condition of Test Sample	Normal
Test Result	Pass
Report Template	AGCRT-EC-RF

The above equipment was tested by SHENZHEN ATTESTATION OF GLOBAL COMPLIANCE (SHENZHEN) CO., LTD. for compliance with the requirements set forth in the European Standard ETSI EN 303 417 V1.1.1. The results of testing in this report apply to the product/system which was tested only. Other similar equipment will not necessarily produce the same results due to production tolerance and measurement uncertainties.

Prepared By 

 John Zeng
 (Project Engineer) Apr. 14, 2022

Reviewed By 

 Calvin Liu
 (Reviewer) Apr. 14, 2022

Approved By 

 Max Zhang
 (Authorized Officer) Apr. 14, 2022

Any report having not been signed by authorized approver, or having been altered without authorization, or having not been stamped by the "Dedicated Testing/Inspection Stamp" is deemed to be invalid. Copying or excerpting portion of, or altering the content of the report is not permitted without the written authorization of AGC. The test results presented in the report apply only to the tested sample. Any objections to report issued by AGC should be submitted to AGC within 15days after the issuance of the test report. Further enquiry of validity or verification of the test report should be addressed to AGC by agc01@agccert.com.

2. EUT DESCRIPTION

Details of technical specification refer to the description in follows:

Hardware Version	Bluetooth-AF0031 V1.0
Software Version	leader.1910.01 V5.0
Operate Frequency	110KHz-205KHz
Modulation Type	FSK
OCW	Energy transmission: Low channel 0.951KHz, Middle Channel 0.956kHz, High channel 0.958KHz Data communication: 0.963KHz
Test Channels	Energy transmission: Low channel 122.7KHz, Middle Channel 136.8kHz, High channel 201.3KHz Data communication: 146.7KHz
Antenna Type	Coil Antenna
Operational Mode	Mode 3: communication Mode 4: energy transmission
Power Supply (Headset)	DC 3.7V by battery
Power Supply(Charging dock)	DC 3.7V by battery or DC 5V by adapter
Wireless Charging Output Power	5W(Max 5W)

NOTE: 1. For more information, please refer to User's Manual.

2. During the initial establishment of the charging mode (mode 2), no or very low emission occur (below the sensitivity level of the test set-up), so the mode 2 can be assumed as irrelevant for the test.

3. Mode 3 and mode 4 have been performed within one set-up, worst-case alignment. But each mode have been tested separately with specific test software.

4. The maximum temperature of 40 is not a standard requirement and is measured according to the maximum service temperature stated by the manufacturer.

3. DESCRIPTION OF TEST ITEMS

Harmonised Standard ETSI EN 303 417		
Requirement		Requirement Conditionality
No	Description	
1	Permitted range of operating frequencies	<input checked="" type="checkbox"/> Applicable <input type="checkbox"/> Not Applicable
2	Operating frequency ranges	<input checked="" type="checkbox"/> Applicable <input type="checkbox"/> Not Applicable
3	H-field requirements	<input checked="" type="checkbox"/> Applicable <input type="checkbox"/> Not Applicable
4	Transmitter spurious emissions	<input checked="" type="checkbox"/> Applicable <input type="checkbox"/> Not Applicable
5	Transmitter out of band (OOB) emissions	<input checked="" type="checkbox"/> Applicable <input type="checkbox"/> Not Applicable
6	WPT system unwanted conducted emissions	<input type="checkbox"/> Applicable <input checked="" type="checkbox"/> Not Applicable
7	Receiver blocking	<input checked="" type="checkbox"/> Applicable <input type="checkbox"/> Not Applicable

4. TEST FACILITY

Test Site	Attestation of Global Compliance (Shenzhen) Co., Ltd
Location	1-2/F, Building 19, Junfeng Industrial Park, Chongqing Road, Heping Community, Fuhai Street, Bao'an District, Shenzhen, Guangdong, China

Any report having not been signed by authorized approver, or having been altered without authorization, or having not been stamped by the "Dedicated Testing/Inspection Stamp" is deemed to be invalid. Copying or excerpting portion of, or altering the content of the report is not permitted without the written authorization of AGC. The test results presented in the report apply only to the tested sample. Any objections to report issued by AGC should be submitted to AGC within 15days after the issuance of the test report. Further enquiry of validity or verification of the test report should be addressed to AGC by agc01@agccert.com.

5. ETSI EN 303 417 REQUIREMENT

5.1 TRANSMITTER H-FIELD REQUIREMENTS

MEASUREMENT EQUIPMENT USED:

NAME OF EQUIPMENT	MANUFACTURER	MODEL	S/N	Cal. Date	Cal. Due
Test Receiver	R&S	ESCI	100034	Sep. 06, 2021	Sep. 05, 2022
Power amplifier	AR	75A250	18464	N/A	N/A
Active loop antenna(9K-30MHz)	ZHINAN	ZN30900C	18051	May 22, 2020	May 21, 2022

TEST SETUP:

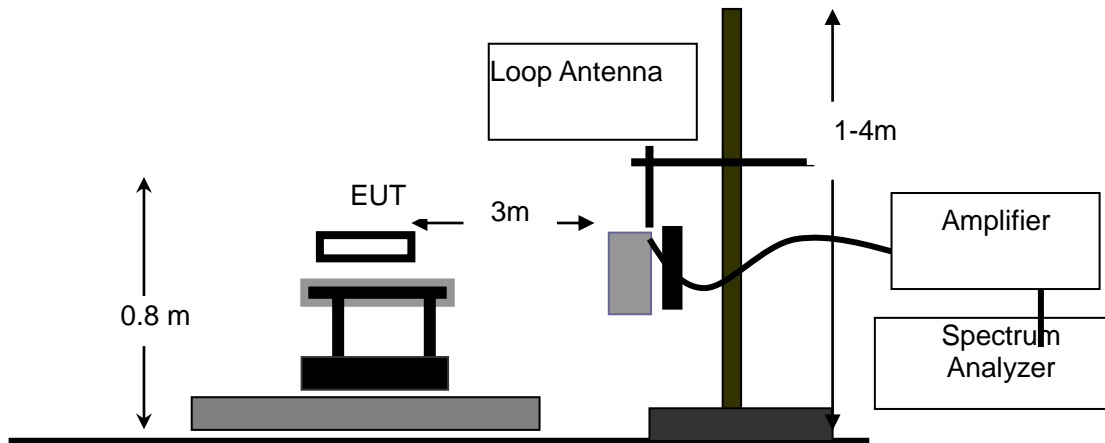

Any report having not been signed by authorized approver, or having been altered without authorization, or having not been stamped by the "Dedicated Testing/Inspection Stamp" is deemed to be invalid. Copying or excerpting portion of, or altering the content of the report is not permitted without the written authorization of AGC. The test results presented in the report apply only to the tested sample. Any objections to report issued by AGC should be submitted to AGC within 15days after the issuance of the test report. Further enquiry of validity or verification of the test report should be addressed to AGC by agc01@agccert.com.

Attestation of Global Compliance(Shenzhen)Co., Ltd

Attestation of Global Compliance(Shenzhen)Std & Tech Co., Ltd

Tel: +86-755 2523 4088 E-mail: agc@agccert.com Web: <http://www.agccert.com/>

TEST LIMITS:

The H-field limit in dBµA/m at 3 m, H_{3m} , is determined by the following equation:

$$H_{3m} = H_{10m} + C_3 \quad (F.2)$$

Where: H_{10m} is the H-field limit in dBµA/m at 10 m distance according to the present document; and C_3 is a conversion factor in dB determined from figure F.2.

According to EN 303 417 Tablet 3,

Table 3: H-field limits

Frequency range [MHz]	H-field strength limit [dBµA/m at 10 m]	Comments
$0,019 \leq f < 0,021$	72	
$0,059 \leq f < 0,061$	69,1 descending 10 dB/dec above 0,059 MHz	See note 1
$0,079 \leq f < 0,090$	67,8 descending 10 dB/dec above 0,079 MHz	See note 2
$0,100 \leq f < 0,119$	42	
$0,119 \leq f < 0,135$	66 descending 10 dB/dec above 0,119 MHz	See note 1
$0,135 \leq f < 0,140$	42	
$0,140 \leq f < 0,1485$	37,7	
$0,1485 \leq f < 0,30$	-5	
$6,765 \leq f < 6,795$	42	

NOTE 1: Limit is 42 dBµA/m for the following spot frequencies: 60 kHz ± 250 Hz and 129,1 kHz ± 500 Hz.
NOTE 2: At the time of preparation of the present document the feasibility of increased limits for high power wireless power transmission systems to charge vehicles [1.4] was prepared. New specific requirements for such systems (e.g. higher H-field emission limits in the 79 - 90 kHz band) will be reflected within a future revision of the present document.

Correction factor, C_3 , for limits at 3 m distance, dB

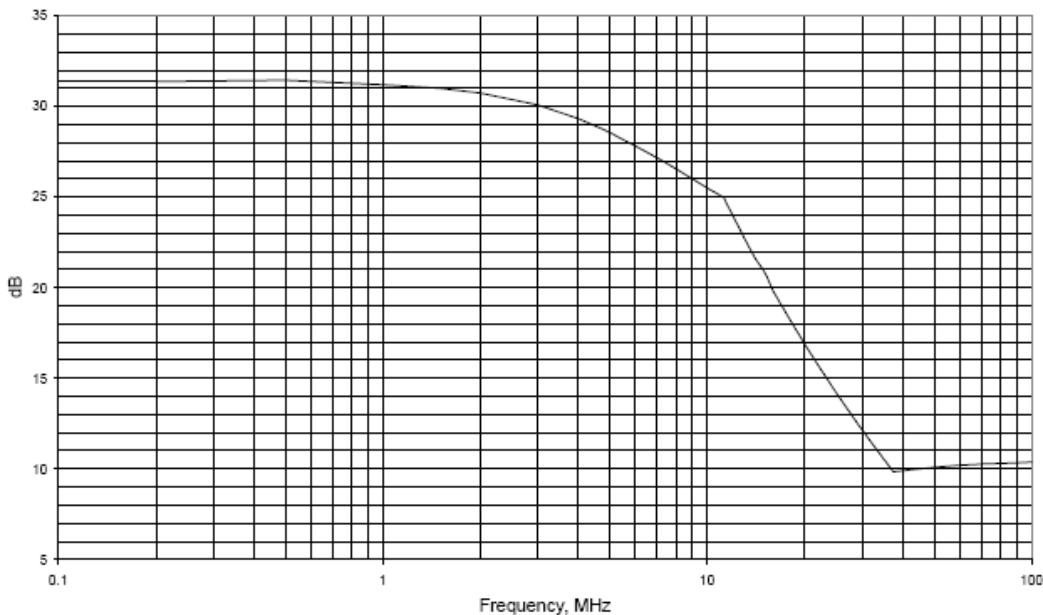

Figure F.2: Conversion factor C_3 versus frequency

Any report having not been signed by authorized approver, or having been altered without authorization, or having not been stamped by the "Dedicated Testing/Inspection Stamp" is deemed to be invalid. Copying or excerpting portion of, or altering the content of the report is not permitted without the written authorization of AGC. The test results presented in the report apply only to the tested sample. Any objections to report issued by AGC should be submitted to AGC within 15 days after the issuance of the test report. Further enquiry of validity or verification of the test report should be addressed to AGC by agc01@agccert.com.

TEST PROCEDURE:

The EUT was placed on the top of an insulating table 0.8 meters above the ground at a semi-anechoic chamber. The table was rotated 360 degrees to determine the position of the highest radiation.

The EUT was set 3 meters away from the interference-receiving antenna, which was mounted on the top of a variable-height antenna tower.

The H-field is measured with a shielded loop antenna connected to a measurement receiver.

The measuring bandwidth and detector type of the measurement receiver shall be in accordance with EN 300 330 V2.1.1 Table 11.

The EUT operate with modulation under normal and extreme conditions.

TEST RESULTS:

Test Mode: Mode 3

Extreme conditions state

conditions	Test Temp	Test Volt.(V)	Note
TN/VN	25°C	5.0	Worst case
TL/VL	-10°C	4.5	
TH/ML	45°C	4.5	
TL/VH	-10°C	5.5	
TH/VH	45°C	5.5	

Test results tested at 3m test sites:

Freq.	Antenna Factor	Reading Level	Corrected Level	Limit
(MHz)	(dB/m)	(dBuA)	(dBuA/m)	(dBuA/m)
0.1336	23.53	4.21	27.74	96.70

Test results calculated to 10m test sites:

Freq.	Antenna Factor	Reading Level	Corrected Level	Limit
(MHz)	(dB/m)	(dBuA)	(dBuA/m)	(dBuA/m)
0.1336	23.53	-26.99	-3.46	65.50

Any report having not been signed by authorized approver, or having been altered without authorization, or having not been stamped by the "Dedicated Testing/Inspection Stamp" is deemed to be invalid. Copying or excerpting portion of, or altering the content of the report is not permitted without the written authorization of AGC. The test results presented in the report apply only to the tested sample. Any objections to report issued by AGC should be submitted to AGC within 15days after the issuance of the test report. Further enquiry of validity or verification of the test report should be addressed to AGC by agc01@agccert.com.

Test Mode: Mode 4

Extreme conditions state

conditions	Test Temp	Test Volt.(V)	Note
TN/VN	25°C	5.0	Worst case
TL/VL	-10°C	4.5	
TH/VL	45°C	4.5	
TL/VH	-10°C	5.5	
TH/VH	45°C	5.5	

Test results tested at 3m test sites:

Freq.	Antenna Factor	Reading Level	Corrected Level	Limit
(MHz)	(dB/m)	(dBuA)	(dBuA/m)	(dBuA/m)
0.1227	23.53	5.32	28.85	96.59
0.1368	23.53	3.87	27.40	73.20
0.2013	23.53	1.45	24.98	26.20

Test results calculated to 10m test sites:

Freq.	Antenna Factor	Reading Level	Corrected Level	Limit
(MHz)	(dB/m)	(dBuA)	(dBuA/m)	(dBuA/m)
0.1227	23.53	-25.88	-2.35	65.39
0.1368	23.53	-27.33	-3.80	42.00
0.2013	23.53	-29.75	-6.22	-5.00

Remark:

- (1) Corrected Level (dBuA/m) = Reading Level + Antenna Factor
- (2) For the calculated method, please refer to Annex F at EN 300330.
- (3) All extreme conditions were considered for test, but only record the worst case.

5.2 OPERATING FREQUENCY RANGES

MEASUREMENT EQUIPMENT USED:

NAME OF EQUIPMENT	MANUFACTURER	MODEL	S/N	Cal. Date	Cal. Due
Test Receiver	R&S	ESCI	100034	Sep. 06, 2021	Sep. 05, 2022
Power amplifier	AR	75A250	18464	N/A	N/A
Active loop antenna(9K-30MHz)	ZHINAN	ZN30900C	18051	May 22, 2020	May 21, 2022

TEST SETUP:

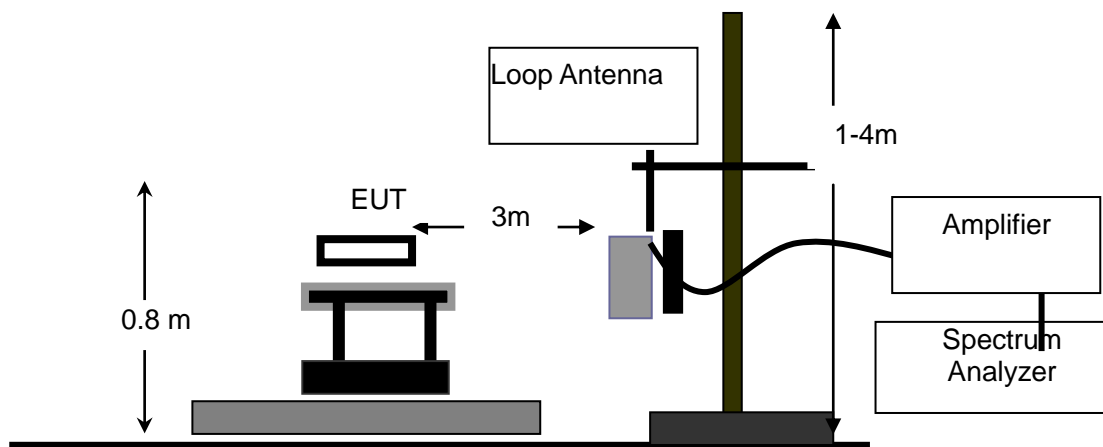

TEST PROCEDURE:

- 1). The EUT was placed on a turn table which is 0.8m above ground plane.
- 2). The EUT was modulated by normal signal,
- 3). Set SPA Center Frequency = fundamental frequency, RBW=VBW=200Hz, Span=5kHz, Detector=RMS. The 99 % OBW function shall be used to determine the operating frequency range, fH is the frequency of the upper marker resulting from the OFR, fL is the frequency of the lower marker resulting from the OFR.
- 4). Both normal test condition and extreme test condition applied

LIMITS

The operating frequency range for emissions shall be within one of the following limits: 19 - 21 kHz, 59 - 61 kHz, 79 - 90 kHz, 100 - 300 kHz, 6 765 - 6 795 kHz.

TEST RESULT

Test Mode: Mode 3

Frequency Range Test Result

Test Temperature	Test Voltage (V DC)	Lowest Frequency(K Hz)	Highest Frequency (KHz)	Limit
-10°C	5.5	133.129	134.071	100kHz≤&≤300kHz
	4.5	133.127	134.072	100kHz≤&≤300kHz
25°C	5.0	133.125	134.075	100kHz≤&≤300kHz
45°C	5.5	133.129	134.072	100kHz≤&≤300kHz
	4.5	133.128	134.075	100kHz≤&≤300kHz
OFR		0.950kHz		
Results		PASS		

Test Mode: Mode 4

Frequency Range Test Result

Test Temperature	Test Voltage (V DC)	Lowest Frequency(K Hz)	Highest Frequency (KHz)	Limit
-10°C	5.5	122.227	201.777	100kHz≤&≤300kHz
	4.5	122.227	201.778	100kHz≤&≤300kHz
25°C	5.0	122.225	201.779	100kHz≤&≤300kHz
45°C	5.5	122.226	201.777	100kHz≤&≤300kHz
	4.5	122.225	201.775	100kHz≤&≤300kHz
OFR		79.555kHz		
Results		PASS		

NOTE: All the modes had been tested, but only the worst data recorded in the report.

Any report having not been signed by authorized approver, or having been altered without authorization, or having not been stamped by the "Dedicated Testing/Inspection Stamp" is deemed to be invalid. Copying or excerpting portion of, or altering the content of the report is not permitted without the written authorization of AGC. The test results presented in the report apply only to the tested sample. Any objections to report issued by AGC should be submitted to AGC within 15days after the issuance of the test report. Further enquiry of validity or verification of the test report should be addressed to AGC by agc01@agccert.com.

Attestation of Global Compliance(Shenzhen)Co., Ltd

Attestation of Global Compliance(Shenzhen)Std & Tech Co., Ltd

Tel: +86-755 2523 4088 E-mail: agc@agccert.com Web: http://www.agccert.com/

5.3 TRANSMITTER OUT OF BAND (OOB) EMISSIONS

MEASUREMENT EQUIPMENT USED:

NAME OF EQUIPMENT	MANUFACTURER	MODEL	S/N	Cal. Date	Cal. Due
Test Receiver	R&S	ESCI	100034	Sep. 06, 2021	Sep. 05, 2022
Power amplifier	AR	75A250	18464	N/A	N/A
Active loop antenna(9K-30MHz)	ZHINAN	ZN30900C	18051	May 22, 2020	May 21, 2022

TEST SETUP:

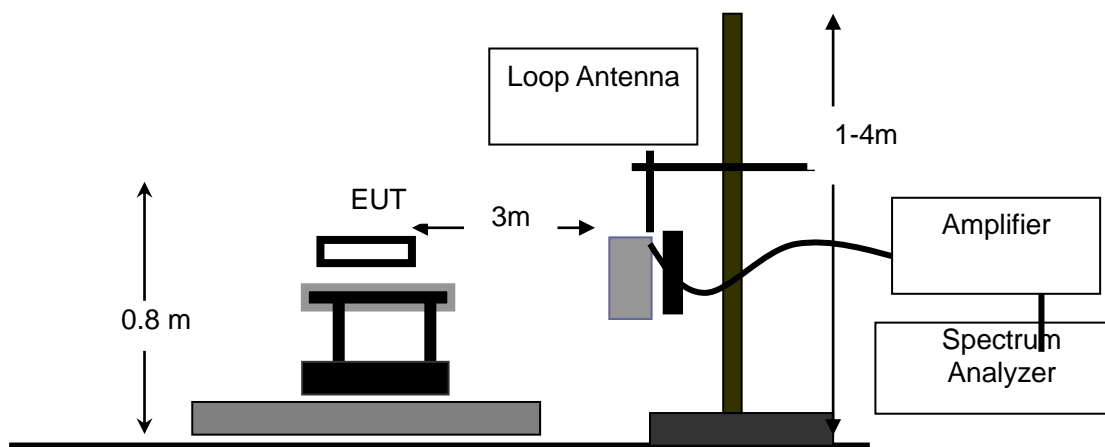

TEST PROCEDURE:

- 1). The EUT was placed on a turn table which is 0.8m above ground plane.
- 2). The EUT was modulated by normal signal,
- 3). Set SPA Center Frequency = fundamental frequency, RBW=VBW=200Hz, Span=5KHz, Detector=RMS. The 99 % OBW function shall be used to determine the operating frequency range, fH is the frequency of the upper marker resulting from the OFR, fL is the frequency of the lower marker resulting from the OFR.
- 4), Both normal test condition and extreme test condition applied

LIMITS

The OOB limits are visualized in figures; they are descending from the intentional limits from Table 3 at fH/fL with 10 dB/decade.

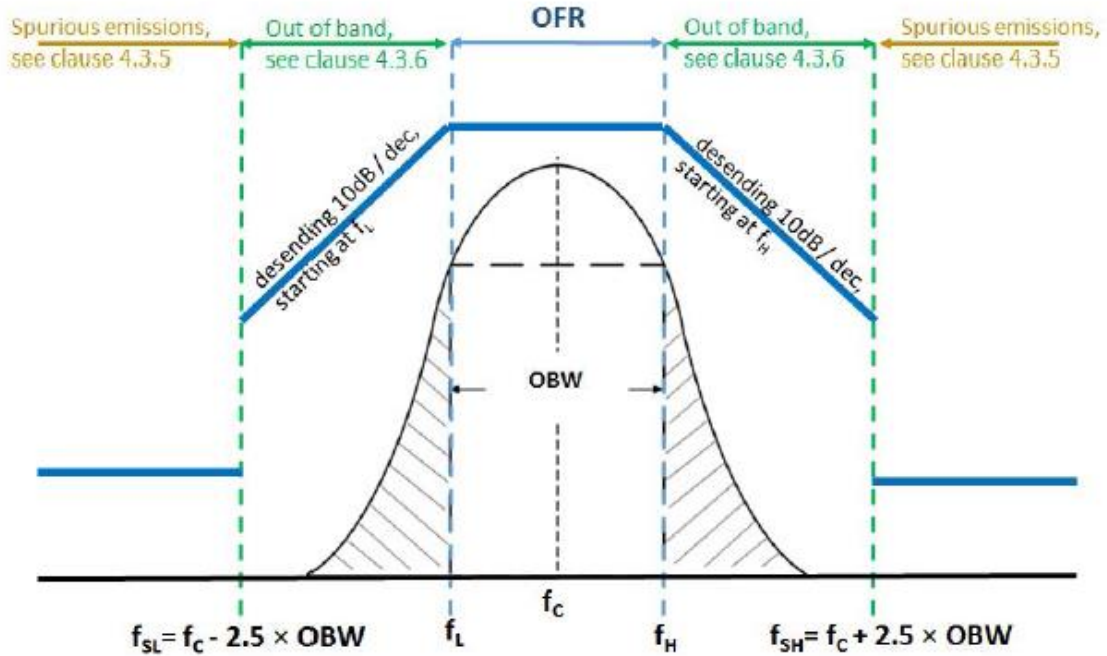

Figure 4: Out of band and spurious domain of a single frequency WPT system

Any report having not been signed by authorized approver, or having been altered without authorization, or having not been stamped by the “Dedicated Testing/Inspection Stamp” is deemed to be invalid. Copying or excerpting portion of, or altering the content of the report is not permitted without the written authorization of AGC. The test results presented in the report apply only to the tested sample. Any objections to report issued by AGC should be submitted to AGC within 15days after the issuance of the test report. Further enquiry of validity or verification of the test report should be addressed to AGC by agc01@agccert.com.

TEST RESULT

Test Mode: Mode 3

Frequency range (KHz)		Maximum level @10m (dBuA/m)	Limit @ 10m (dBuA/m)	Result
fSL-fL	131.225 to 133.125	Less than -12.62	See figure 4	Pass
fL	133.125	-12.62	65.50	Pass
fH	134.075	-13.14	65.50	Pass
fH-fSH	134.075 to 135.975	Less than -13.14	See figure 4	Pass

Test Mode: Mode 4

Frequency range (KHz)		Maximum level @10m (dBuA/m)	Limit @ 10m (dBuA/m)	Result
fSL-fL	120.323 to 122.225	Less than -11.51	See figure 4	Pass
fL	122.225	-11.51	65.39	Pass
fH	201.779	-15.90	-5.00	Pass
fH-fSH	201.779 to 203.695	Less than -15.9	See figure 4	Pass

NOTE: All the modes had been tested, but only the worst data recorded in the report.

Any report having not been signed by authorized approver, or having been altered without authorization, or having not been stamped by the "Dedicated Testing/Inspection Stamp" is deemed to be invalid. Copying or excerpting portion of, or altering the content of the report is not permitted without the written authorization of AGC. The test results presented in the report apply only to the tested sample. Any objections to report issued by AGC should be submitted to AGC within 15days after the issuance of the test report. Further enquiry of validity or verification of the test report should be addressed to AGC by agc01@agccert.com.

Attestation of Global Compliance(Shenzhen)Co., Ltd

Attestation of Global Compliance(Shenzhen)Std & Tech Co., Ltd

Tel: +86-755 2523 4088 E-mail: agc@agccert.com Web: http://www.agccert.com/

5.4 TRANSMITTER SPURIOUS EMISSIONS

MEASUREMENT EQUIPMENT USED:

NAME OF EQUIPMENT	MANUFACTURER	MODEL	S/N	Cal. Date	Cal. Due
Test Receiver	R&S	ESCI	100034	Sep. 06, 2021	Sep. 05, 2022
Power amplifier	AR	75A250	18464	N/A	N/A
Active loop antenna(9K-30MHz)	ZHINAN	ZN30900C	18051	May 22, 2020	May 21, 2022
Wideband Antenna	SCHWARZBECK	VULB9168	D69250	Apr. 28, 2021	Apr. 27, 2023

TEST SETUP:

FREQUENCY RANGE (9KHZ-30MHZ)

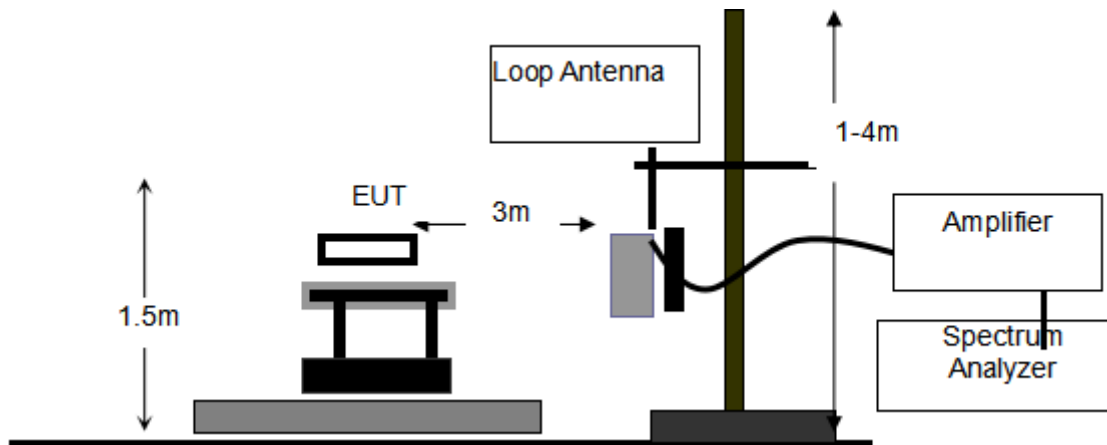

FREQUENCY RANGE (ABOVE 30MHZ)

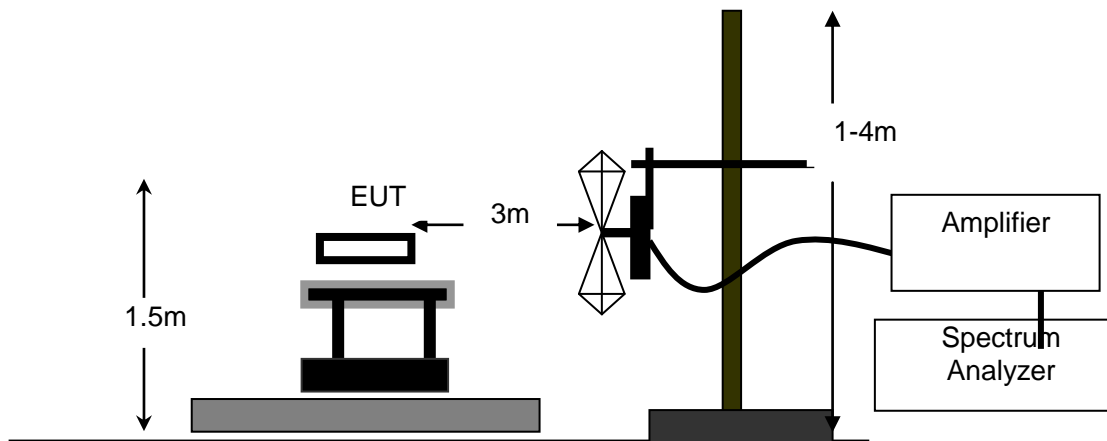

Any report having not been signed by authorized approver, or having been altered without authorization, or having not been stamped by the "Dedicated Testing/Inspection Stamp" is deemed to be invalid. Copying or excerpting portion of, or altering the content of the report is not permitted without the written authorization of AGC. The test results presented in the report apply only to the tested sample. Any objections to report issued by AGC should be submitted to AGC within 15days after the issuance of the test report. Further enquiry of validity or verification of the test report should be addressed to AGC by agc01@agccert.com.

SUBSTITUTION METHOD:

RADIATED BELOW 1GHZ

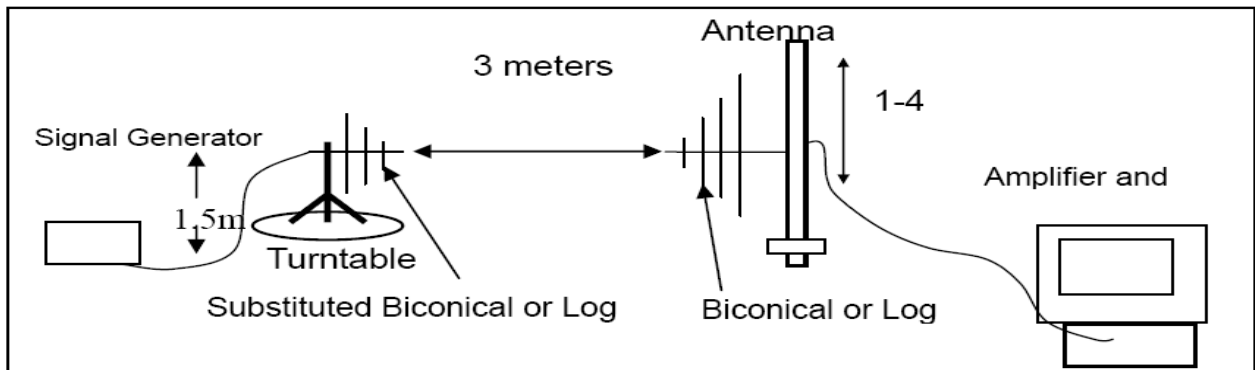

TEST PROCEDURE:

For test method of frequency range (9kHz-30MHz)

The EUT was placed on the top of an insulating table 1.5 meters above the ground at a semi-anechoic chamber. The table was rotated 360 degrees to determine the position of the highest radiation.

The EUT was set 3 meters away from the interference-receiving antenna, which was mounted on the top of a variable-height antenna tower.

The H-field is measured with a shielded loop antenna connected to a measurement receiver.

The measuring bandwidth and detector type of the measurement receiver shall be in accordance with EN 300 330 Table 1.

For test method of frequency range (30 MHz-1000MHz)

EUT was placed on a 1.5m height wooden table. The search antenna is placed at 3m distances from the EUT and search antenna height is from 1-4m. With the transmitter operating at continuously mode, the turntable was slowly rotated to locate the direction of maximum emission. Once maximum direction is determined, the search antenna was raised and lowered in both vertical and horizontal polarizations.

The EUT was removed from the turntable and replaced with a linearly polarized antenna connected to a calibrated RF signal generator. The RF generator was set to a measured emission frequency and the search antenna was raised and lowered to produce a maximum received reading. The generator output was increased to match the radiated emission reading measured previously, and the result expressed in dB EIRP or ERP, correcting for substitution antenna gain at each frequency.

LIMITS OF RADIATED DISTURBANCES

Below 30MHz

Table 4

State (see note)	Frequency 9 kHz ≤ f < 10 MHz	Frequency 10 MHz ≤ f < 30 MHz
Operating	27 dBμA/m at 9 kHz descending 10 dB/dec	-3,5 dBμA/m
Standby	5,5 dBμA/m at 9 kHz descending 10 dB/dec	-25 dBμA/m
NOTE: "Operating" means mode 2, 3 and 4 according to Table 2; "standby" means mode 1 according to Table 2.		

ABOVE 30MHz

Table 5

State (see note)	47 MHz to 74 MHz 87,5 MHz to 118 MHz 174 MHz to 230 MHz 470 MHz to 790 MHz	Other frequencies between 30 MHz to 1 000 MHz
Operating	4 nW	250 nW
Standby	2 nW	2 nW
NOTE: "Operating" means mode 2, 3 and 4 according to Table 2; "standby" means mode 1 according to Table 2.		

Any report having not been signed by authorized approver, or having been altered without authorization, or having not been stamped by the "Dedicated Testing/Inspection Stamp" is deemed to be invalid. Copying or excerpting portion of, or altering the content of the report is not permitted without the written authorization of AGC. The test results presented in the report apply only to the tested sample. Any objections to report issued by AGC should be submitted to AGC within 15days after the issuance of the test report. Further enquiry of validity or verification of the test report should be addressed to AGC by agc01@agccert.com.

TEST LIMITS & RESULT

Test Mode: Mode 3
FREQUENCY RANGE (9KHZ-30MHZ)

Operation Mode					
Frequency	Reading level	Total Factor	Emission level	Limit	Margin
(MHz)	(dB μ A)	(dB/m)	(dB μ A/m)	(dB μ A/m)	(dB μ A/m)
0.042	-7.73	-7.96	-15.69	20.35	36.03
0.256	-11.45	-7.96	-19.41	12.47	31.88
0.502	-12.76	-7.96	-20.72	9.54	30.25
1.512	-14.71	-3.98	-18.69	4.75	23.44
2.601	-13.38	-3.09	-16.47	2.39	18.86
4.636	-12.54	-1.25	-13.79	-0.12	13.67

Remark:

- (1) Corrected Power (dBm)= Total Factor + Reading Level
- (2) Measuring frequencies from 9KHz to the 30MHz.
- (3) Data of measurement within this frequency range shown “ -- ” in the table above means the reading of emissions are attenuated more than 20dB below the permissible limits or the field strength is too small to be measured.

Any report having not been signed by authorized approver, or having been altered without authorization, or having not been stamped by the “Dedicated Testing/Inspection Stamp” is deemed to be invalid. Copying or excerpting portion of, or altering the content of the report is not permitted without the written authorization of AGC. The test results presented in the report apply only to the tested sample. Any objections to report issued by AGC should be submitted to AGC within 15days after the issuance of the test report. Further enquiry of validity or verification of the test report should be addressed to AGC by agc01@agccert.com.

FREQUENCY RANGE (ABOVE 30MHZ)

Transmitter Spurious Emission below 1GHz (30MHz-1GHz)

Frequency	Reading Level	Antenna	S.G.	Cable Loss	Ant.Gain	Emission Level	Limit	Margin
(MHz)	(dBuV/m)	Polarization	(dBm)	(dB)	(dBi)	(dBm)	(dBm)	(dB)
62.76	31.86	V	-56.78	0.03	-4.44	-61.25	-54.00	7.25
161.84	27.97	V	-67.26	0.06	1.28	-66.04	-36.00	30.04
357.63	31.72	V	-67.24	0.25	6.41	-61.08	-36.00	25.08
425.02	27.17	V	-72.47	0.33	7.00	-65.80	-36.00	29.80
631.48	29.03	V	-70.30	0.52	7.28	-63.53	-54.00	9.53
758.06	27.08	V	-72.72	0.61	6.50	-66.83	-36.00	30.83
85.73	30.66	H	-62.33	0.04	0.70	-61.67	-36.00	25.67
152.51	26.63	H	-68.04	0.06	0.70	-67.40	-36.00	31.40
350.59	28.33	H	-69.71	0.25	5.50	-64.45	-36.00	28.45
431.64	26.99	H	-71.89	0.34	6.83	-65.40	-36.00	29.40
628.53	28.95	H	-71.89	0.51	7.22	-65.18	-54.00	11.18
727.54	28.24	H	-71.86	0.59	6.65	-65.79	-36.00	29.79

Note: 1.The margins of the other spectrum are not exceeding the minimum value of margin, and this part of the results without recording in the test report.

2. Measurements above show only up to 6 maximum emissions noted, or would be lesser, with "--" remark, if no specific emission from the EUT are recorded (ie: margin>20dB from the applicable limit) and considered that's already beyond the background noise floor.

Test Mode: Mode 4(The low channel is the worst case)
FREQUENCY RANGE (9KHZ-30MHZ)

Operation Mode					
Frequency	Reading level	Total Factor	Emission level	Limit	Margin
(MHz)	(dB μ A)	(dB/m)	(dB μ A/m)	(dB μ A/m)	(dB μ A/m)
0.043	-7.79	-7.96	-15.75	20.19	35.94
0.302	-11.15	-7.96	-19.11	11.74	30.85
0.721	-12.75	-7.96	-20.71	7.96	28.67
2.074	-14.43	-3.98	-18.41	3.37	21.79
2.432	-13.05	-3.09	-16.14	2.68	18.82
4.503	-12.63	-1.25	-13.88	0.01	13.89

Remark:

- (1) Corrected Power (dBm) = Total Factor + Reading Level
- (2) Measuring frequencies from 9KHz to the 30MHz.
- (3) Data of measurement within this frequency range shown “ -- ” in the table above means the reading of emissions are attenuated more than 20dB below the permissible limits or the field strength is too small to be measured.

Any report having not been signed by authorized approver, or having been altered without authorization, or having not been stamped by the “Dedicated Testing/Inspection Stamp” is deemed to be invalid. Copying or excerpting portion of, or altering the content of the report is not permitted without the written authorization of AGC. The test results presented in the report apply only to the tested sample. Any objections to report issued by AGC should be submitted to AGC within 15days after the issuance of the test report. Further enquiry of validity or verification of the test report should be addressed to AGC by agc01@agccert.com.

Attestation of Global Compliance(Shenzhen)Co., Ltd

Attestation of Global Compliance(Shenzhen)Std & Tech Co., Ltd

Tel: +86-755 2523 4088 E-mail: agc@agccert.com Web: http://www.agccert.com/

FREQUENCY RANGE (ABOVE 30MHZ)

Transmitter Spurious Emission below 1GHz (30MHz-1GHz)

Frequency	Reading Level	Antenna	S.G.	Cable Loss	Ant.Gain	Emission Level	Limit	Margin
(MHz)	(dBuV/m)	Polarization	(dBm)	(dB)	(dBi)	(dBm)	(dBm)	(dB)
76.59	32.12	V	-59.58	0.04	-0.90	-60.52	-36.00	24.52
154.07	28.41	V	-65.66	0.06	0.70	-65.02	-36.00	29.02
356.93	31.51	V	-67.50	0.25	6.28	-61.48	-36.00	25.48
428.80	27.04	V	-72.37	0.34	6.94	-65.77	-36.00	29.77
628.04	29.85	V	-70.04	0.51	7.22	-63.34	-54.00	9.34
759.51	28.66	V	-69.81	0.61	6.55	-63.87	-36.00	27.87
97.31	31.35	H	-62.57	0.04	1.60	-61.01	-54.00	7.01
155.70	26.97	H	-66.09	0.06	0.70	-65.45	-36.00	29.45
349.26	29.92	H	-67.87	0.24	5.52	-62.59	-36.00	26.59
430.93	27.60	H	-72.16	0.34	6.90	-65.60	-36.00	29.60
632.88	29.14	H	-71.46	0.52	7.26	-64.72	-54.00	10.72
727.26	28.24	H	-71.28	0.59	6.65	-65.22	-36.00	29.22

Note: 1.The margins of the other spectrum are not exceeding the minimum value of margin, and this part of the results without recording in the test report.

2. Measurements above show only up to 6 maximum emissions noted, or would be lesser, with "--" remark, if no specific emission from the EUT are recorded (ie: margin>20dB from the applicable limit) and considered that's already beyond the background noise floor.

5.5 RECEIVER BLOCKING

MEASUREMENT EQUIPMENT USED:

NAME OF EQUIPMENT	MANUFACTURER	MODEL	S/N	Cal. Date	Cal. Due
MXG X-Series Vector Signal Generator	Agilent	N5182B	MY53050647	Aug. 18, 2021	Aug. 17, 2022
Active loop antenna(9K-30MHz)	ZHINAN	ZN30900C	18051	May 22, 2020	May 21, 2022
Clamp meter	PROVA	PROVA-11	17200101	Sep. 13, 2021	Sep. 14, 2022

TEST SETUP:

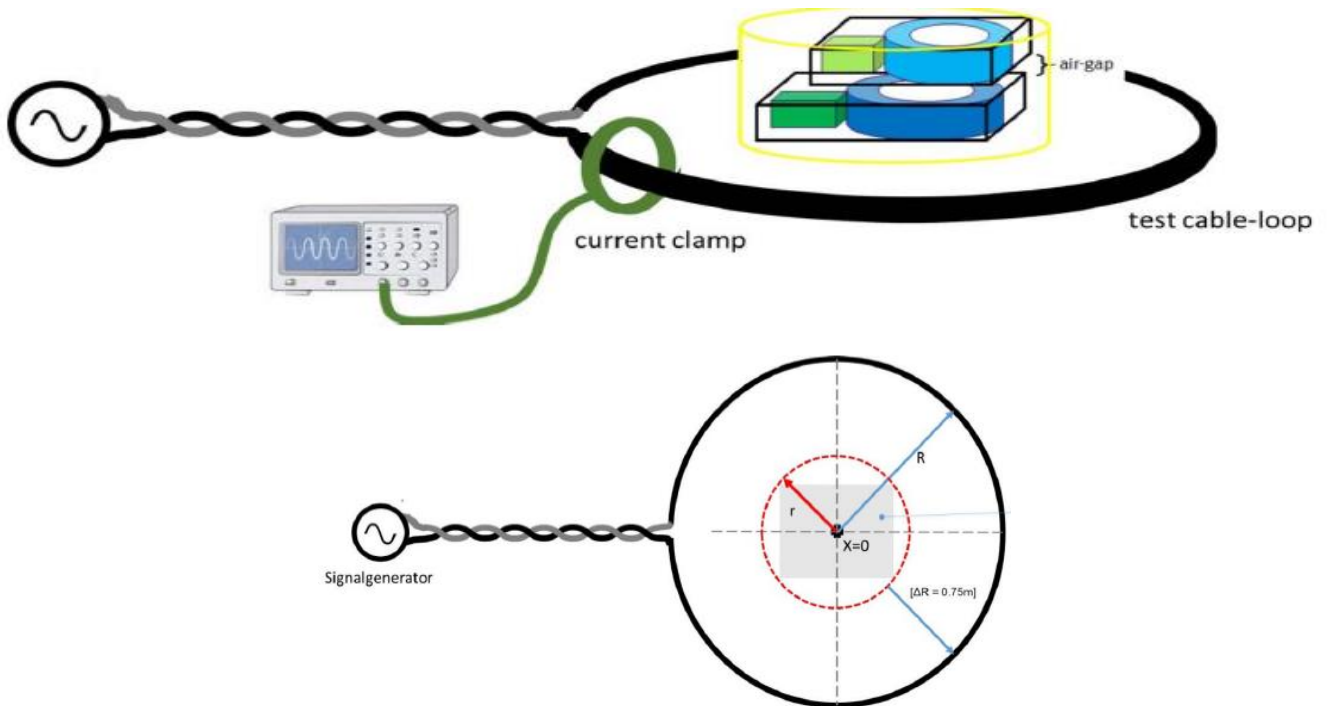

TEST PROCEDURE:

- 1). The test shall be carried out inside a test chamber according to clauses C.1.1 and C.1.2 in ETSI EN 300 330
- 2). A test loop with a radius r shall be used to create the magnetic field; the test loop shall lie on a non-metallic ground and the minimum distance to metallic objects (e.g. ground plane) shall be 0,75 m. The EUT shall be placed to the centre of the test-loop
- 3). The test loop shall be sufficiently large so that the test loop itself does not influence the WPT system; The radius R of the test-loop shall be in minimum $\Delta R = 0,75$ m larger than the maximum dimension r of the EUT.

$$R \geq r + \Delta R.$$

The maximum H-Field can be calculated from the loop current I (into the test-loop) with the following formula:

$$H = I/2R$$

Any report having not been signed by authorized approver, or having been altered without authorization, or having not been stamped by the "Dedicated Testing/Inspection Stamp" is deemed to be invalid. Copying or excerpting portion of, or altering the content of the report is not permitted without the written authorization of AGC. The test results presented in the report apply only to the tested sample. Any objections to report issued by AGC should be submitted to AGC within 15 days after the issuance of the test report. Further enquiry of validity or verification of the test report should be addressed to AGC by agc01@agccert.com.

4)The required output current to achieve the required magnetic field at the WPT system shall be generated with a signal generator (unmodulated signal) at the test frequencies. For each test frequency the "reaction" of the device shall be recorded and checked against the performance criterion

LIMITS

The EUT shall achieve the wanted performance criterion, in the presence of the blocking signal.

Table 6: Receiver blocking limits

	In-band signal	OOB signal	Remote-band signal
Frequency	Centre frequency (f_c) of the WPT system (see clause 4.3.3)	$f = f_c \pm F$ (see note)	$f = f_c \pm 10 \times F$ (see note)
Signal level field strength at the EUT	72 dB μ A/m	72 dB μ A/m	82 dB μ A/m
NOTE: F = OFR see clause 4.3.3.			

TEST RESULT

Test Mode: Mode 3

Test Frequency(KHz)		Signal level @ EUT	Performance	Result
In-band signal	133.600	72dBuA/m	No function loss	Pass
OOB signal	132.650	72dBuA/m	No function loss	Pass
	134.550	72dBuA/m	No function loss	Pass
Remote-band signal	124.100	82dBuA/m	No function loss	Pass
	143.100	82dBuA/m	No function loss	Pass

Any report having not been signed by authorized approver, or having been altered without authorization, or having not been stamped by the "Dedicated Testing/Inspection Stamp" is deemed to be invalid. Copying or excerpting portion of, or altering the content of the report is not permitted without the written authorization of AGC. The test results presented in the report apply only to the tested sample. Any objections to report issued by AGC should be submitted to AGC within 15days after the issuance of the test report. Further enquiry of validity or verification of the test report should be addressed to AGC by agc01@agccert.com.

Attestation of Global Compliance(Shenzhen)Co., Ltd

Attestation of Global Compliance(Shenzhen)Std & Tech Co., Ltd

Tel: +86-755 2523 4088 E-mail: agc@agccert.com Web: http://www.agccert.com/

6. INTERPRETATION OF MEASUREMENT RESULTS

All the measurement equipments and accessories have been carefully selected to meet the maximum measurement uncertainty specified below:

RF Frequency	$\pm 1 \times 10^{-7}$
RF Power, Conducted	$\pm 0.75\text{dB}$
Maximum Frequency Deviation: _ Within 300Hz and 6KHz of Audio Frequency _ Within 6KHz and 25KHz of Audio Frequency	$\pm 5\%$ $\pm 3\text{dB}$
Adjacent channel power	$\pm 3\text{dB}$
Conducted Emission of Transmitter, Valid Up to 12.75GHz	$\pm 4\text{dB}$
Conducted Emissions of Receivers	$\pm 3\text{dB}$
Radiated Emission of Transmitter, Valid Up to 12.75GHz	$\pm 6\text{dB}$

P.S. Uncertainty figures are valid to confidence level of 95% calculated according to the methods described in the ETSI TR 100 028.

Any report having not been signed by authorized approver, or having been altered without authorization, or having not been stamped by the "Dedicated Testing/Inspection Stamp" is deemed to be invalid. Copying or excerpting portion of, or altering the content of the report is not permitted without the written authorization of AGC. The test results presented in the report apply only to the tested sample. Any objections to report issued by AGC should be submitted to AGC within 15days after the issuance of the test report. Further enquiry of validity or verification of the test report should be addressed to AGC by agc01@agccert.com.

Attestation of Global Compliance(Shenzhen)Co., Ltd

Attestation of Global Compliance(Shenzhen)Std & Tech Co., Ltd

Tel: +86-755 2523 4088 E-mail: agc@agccert.com Web: <http://www.agccert.com/>

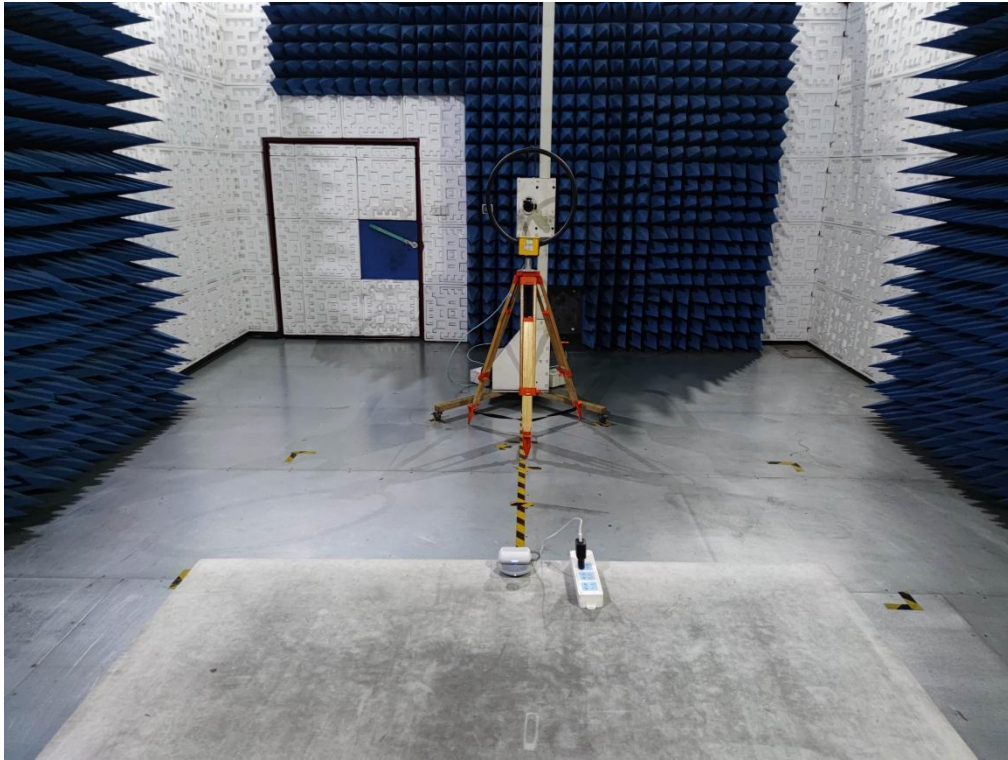
APPENDIX A: PHOTOGRAPHS OF TEST SETUP

Any report having not been signed by authorized approver, or having been altered without authorization, or having not been stamped by the “Dedicated Testing/Inspection Stamp” is deemed to be invalid. Copying or excerpting portion of, or altering the content of the report is not permitted without the written authorization of AGC. The test results presented in the report apply only to the tested sample. Any objections to report issued by AGC should be submitted to AGC within 15days after the issuance of the test report. Further enquiry of validity or verification of the test report should be addressed to AGC by agc01@agccert.com.

Attestation of Global Compliance(Shenzhen)Co., Ltd

Attestation of Global Compliance(Shenzhen)Std & Tech Co., Ltd

Tel: +86-755 2523 4088 E-mail: agc@agccert.com Web: <http://www.agccert.com/>

APPENDIX B: PHOTOGRAPHS OF THE EUT

Refer to the Report No.: AGC05443220333AP01

----END OF REPORT----

Any report having not been signed by authorized approver, or having been altered without authorization, or having not been stamped by the “Dedicated Testing/Inspection Stamp” is deemed to be invalid. Copying or excerpting portion of, or altering the content of the report is not permitted without the written authorization of AGC. The test results presented in the report apply only to the tested sample. Any objections to report issued by AGC should be submitted to AGC within 15days after the issuance of the test report. Further enquiry of validity or verification of the test report should be addressed to AGC by agc01@agccert.com.

Attestation of Global Compliance(Shenzhen)Co., Ltd

Attestation of Global Compliance(Shenzhen)Std & Tech Co., Ltd

Tel: +86-755 2523 4088 E-mail: agc@agccert.com Web: <http://www.agccert.com/>



Conditions of Issuance of Test Reports

1. All samples and goods are accepted by the Attestation of Global Compliance (Shenzhen) Co., Ltd (the “Company”) solely for testing and reporting in accordance with the following terms and conditions. The company provides its services on the basis that such terms and conditions constitute express agreement between the company and any person, firm or company requesting its services (the “Clients”).
2. Any report issued by Company as a result of this application for testing services (the “Report”) shall be issued in confidence to the Clients and the Report will be strictly treated as such by the Company. It may not be reproduced either in its entirety or in part and it may not be used for advertising or other unauthorized purposes without the written consent of the Company. The Clients to whom the Report is issued may, however, show or send it, or a certified copy thereof prepared by the Company to its customer, supplier or other persons directly concerned. The Company will not, without the consent of the Clients, enter into any discussion or correspondence with any third party concerning the contents of the Report, unless required by the relevant governmental authorities, laws or court orders.
3. The Company shall not be called or be liable to be called to give evidence or testimony on the Report in a court of law without its prior written consent, unless required by the relevant governmental authorities, laws or court orders.
4. In the event of the improper use of the report as determined by the Company, the Company reserves the right to withdraw it, and to adopt any other additional remedies which may be appropriate.
5. Samples submitted for testing are accepted on the understanding that the Report issued cannot form the basis of, or be the instrument for, any legal action against the Company.
6. The Company will not be liable for or accept responsibility for any loss or damage however arising from the use of information contained in any of its Reports or in any communication whatsoever about its said tests or investigations.
7. Clients wishing to use the Report in court proceedings or arbitration shall inform the Company to that effect prior to submitting the sample for testing.
8. The Company is not responsible for recalling the electronic version of the original report when any revision is made to them. The Client assumes the responsibility to providing the revised version to any interested party who uses them.
9. Subject to the variable length of retention time for test data and report stored hereinto as otherwise specifically required by individual accreditation authorities, the Company will only keep the supporting test data and information of the test report for a period of six years. The data and information will be disposed of after the aforementioned retention period has elapsed. Under no circumstances shall we provide any data and information which has been disposed of after retention period. Under no circumstances shall we be liable for damage of any kind, including (but not limited to) compensatory damages, lost profits, lost data, or any form of special, incidental, indirect, consequential or punitive damages of any kind, whether based on breach of contract of warranty, tort (including negligence), product liability or otherwise, even if we are informed in advance of the possibility of such damages.

Any report having not been signed by authorized approver, or having been altered without authorization, or having not been stamped by the “Dedicated Testing/Inspection Stamp” is deemed to be invalid. Copying or excerpting portion of, or altering the content of the report is not permitted without the written authorization of AGC. The test results presented in the report apply only to the tested sample. Any objections to report issued by AGC should be submitted to AGC within 15 days after the issuance of the test report. Further enquiry of validity or verification of the test report should be addressed to AGC by agc01@agccert.com.

Health Test Report

Report No.: AGC05443220333EH03

PRODUCT DESIGNATION : Wireless charging earbuds
BRAND NAME : N/A
MODEL NAME : M09768
APPLICANT : MID OCEAN BRANDS B.V
DATE OF ISSUE : Apr. 14, 2022
STANDARD(S) : EN IEC 62311:2020
: EN 50665:2017
REPORT VERSION : V1.0

Attestation of Global Compliance (Shenzhen) Co., Ltd.



Any report having not been signed by authorized approver, or having been altered without authorization, or having not been stamped by the "Dedicated Testing/Inspection Stamp" is deemed to be invalid. Copying or excerpting portion of, or altering the content of the report is not permitted without the written authorization of AGC. The test results presented in the report apply only to the tested sample. Any objections to report issued by AGC should be submitted to AGC within 15days after the issuance of the test report. Further enquiry of validity or verification of the test report should be addressed to AGC by agc01@agccert.com.

Attestation of Global Compliance(Shenzhen)Co., Ltd

Attestation of Global Compliance(Shenzhen)Std & Tech Co., Ltd

Tel: +86-755 2523 4088 E-mail: agc@agccert.com Web: <http://www.agccert.com/>

REPORT REVISE RECORD

Report Version	Revise Time	Issued Date	Valid Version	Notes
V1.0	/	Apr. 14, 2022	Valid	Initial release

Any report having not been signed by authorized approver, or having been altered without authorization, or having not been stamped by the "Dedicated Testing/Inspection Stamp" is deemed to be invalid. Copying or excerpting portion of, or altering the content of the report is not permitted without the written authorization of AGC. The test results presented in the report apply only to the tested sample. Any objections to report issued by AGC should be submitted to AGC within 15days after the issuance of the test report. Further enquiry of validity or verification of the test report should be addressed to AGC by agc01@agccert.com.

TABLE OF CONTENTS

1. GENERAL INFORMATION	4
2. TECHNICAL INFORMATION	5
3. RF EXPOSURE MEASUREMENT	6
3.1 INTRODUCTION.....	6
3.2 TEST LIMIT	7
3.3 EVALUATION METHODS	8
4. TEST EQUIPMENT LIST	9
5. EUT OPERATION CONDITION.....	9
6. TEST RESULT	10
7. CONCLUSION	10

Any report having not been signed by authorized approver, or having been altered without authorization, or having not been stamped by the “Dedicated Testing/Inspection Stamp” is deemed to be invalid. Copying or excerpting portion of, or altering the content of the report is not permitted without the written authorization of AGC. The test results presented in the report apply only to the tested sample. Any objections to report issued by AGC should be submitted to AGC within 15days after the issuance of the test report. Further enquiry of validity or verification of the test report should be addressed to AGC by agc01@agccert.com.

1. GENERAL INFORMATION

Applicant	MID OCEAN BRANDS B.V
Address	7/F, Kings Tower, 111 King Lam Street, Cheung Sha Wan, Kowloon, Hong Kong
Manufacturer	MID OCEAN BRANDS B.V
Address	7/F, Kings Tower, 111 King Lam Street, Cheung Sha Wan, Kowloon, Hong Kong
Factory	MID OCEAN BRANDS B.V
Address	7/F, Kings Tower, 111 King Lam Street, Cheung Sha Wan, Kowloon, Hong Kong
Product Designation	Wireless charging earbuds
Brand Name	N/A
Test Model	MO9768
Date of test	Mar. 31, 2022 to Apr. 12, 2022
Test Result	Pass

We (AGC), Attestation of Global Compliance (Shenzhen) Co., Ltd. for compliance with the requirements set forth in the European Standard EN IEC 62311:2020. The results of testing in this report apply to the product/system which was tested only.

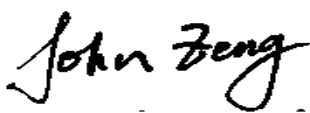
Prepared By 

 John Zeng
 (Project Engineer) Apr. 14, 2022

Reviewed By 

 Calvin Liu
 (Reviewer) Apr. 14, 2022

Approved By 

 Max Zhang
 (Authorized Officer) Apr. 14, 2022

Any report having not been signed by authorized approver, or having been altered without authorization, or having not been stamped by the "Dedicated Testing/Inspection Stamp" is deemed to be invalid. Copying or excerpting portion of, or altering the content of the report is not permitted without the written authorization of AGC. The test results presented in the report apply only to the tested sample. Any objections to report issued by AGC should be submitted to AGC within 15days after the issuance of the test report. Further enquiry of validity or verification of the test report should be addressed to AGC by agc01@agccert.com.

2. TECHNICAL INFORMATION

The following data is based on the information by the applicant.

Product Designation	Wireless charging earbuds
Brand Name	N/A
Test Model	MO9768
Hardware Version	Bluetooth-AF0031 V1.0
Software Version	leader.1910.01 V5.0
Operation Frequency	110KHz-205KHz
Modulation Type	FSK
Antenna Type	Coil Antenna
Antenna Gain	0dBi
Power Supply (Headset)	DC 3.7V by battery
Power Supply(Charging dock)	DC 3.7V by battery or DC 5V by adapter
Wireless Charging Output Power	5W(Max 5W)

Note: For more details, please refer to the user's manual of the EUT.

3. RF EXPOSURE MEASUREMENT

3.1 INTRODUCTION

This International Standard applies to electronic and electrical equipment for which no dedicated product- or product family standard regarding human exposure to electromagnetic fields applies.

This generic standard applies to electronic and electrical apparatus for which no dedicated product- or product family standard regarding human exposure to electromagnetic fields applies.

The frequency range covered is 0 Hz to 300 GHz.

The object of this generic standard is to provide assessment methods and criteria to evaluate such equipment against basic restrictions or reference levels on exposure of the general public related to electric, magnetic, electromagnetic fields and induced and contact current.

NOTE: This standard is intended to cover both intentional and non-intentional radiators. If the equipment complies with the requirements in another relevant standard, e.g. EN 62479 covering low power equipment, then the requirements of this standard (IEC 62311) are considered to be met and the application of this standard to that equipment is not necessary.

3.2 TEST LIMIT

According to EN IEC 62311:2020, Assessment of electronic and electrical equipment related to human exposure restrictions for electromagnetic fields (0 Hz – 300 GHz).

Annex F Measurement of E and H field

A commonly used probe size is 100 cm², also the contribution of the three axes X, Y and Z can be evaluated separately.

Reference levels for electric, magnetic and electromagnetic fields
(0 Hz to 300 GHz, unperturbed rms values)

Frequency range	E-field strength (V/m)	H-field strength (A/m)	B-field (μT)	Equivalent plane wave power density S_{eq} (W/m ²)
0-1 Hz	—	$3,2 \times 10^4$	4×10^4	—
1-8 Hz	10 000	$3,2 \times 10^4/f^2$	$4 \times 10^4/f^2$	—
8-25 Hz	10 000	$4\,000/f$	$5\,000/f$	—
0,025-0,8 kHz	$250/f$	$4/f$	$5/f$	—
0,8-3 kHz	$250/f$	5	6,25	—
3-150 kHz	87	5	6,25	—
0,15-1 MHz	87	$0,73/f$	$0,92/f$	—
1-10 MHz	$87/f^{1/2}$	$0,73/f$	$0,92/f$	—
10-400 MHz	28	0,073	0,092	2
400-2 000 MHz	$1,375 f^{1/2}$	$0,0037 f^{1/2}$	$0,0046 f^{1/2}$	$f/200$
2-300 GHz	61	0,16	0,20	10

Any report having not been signed by authorized approver, or having been altered without authorization, or having not been stamped by the “Dedicated Testing/Inspection Stamp” is deemed to be invalid. Copying or excerpting portion of, or altering the content of the report is not permitted without the written authorization of AGC. The test results presented in the report apply only to the tested sample. Any objections to report issued by AGC should be submitted to AGC within 15days after the issuance of the test report. Further enquiry of validity or verification of the test report should be addressed to AGC by agc01@agccert.com.

3.3 EVALUATION METHODS

Measurement of E and H field

A commonly used probe size is 100 cm², also the contribution of the three axes X, Y and Z can be evaluated separately.

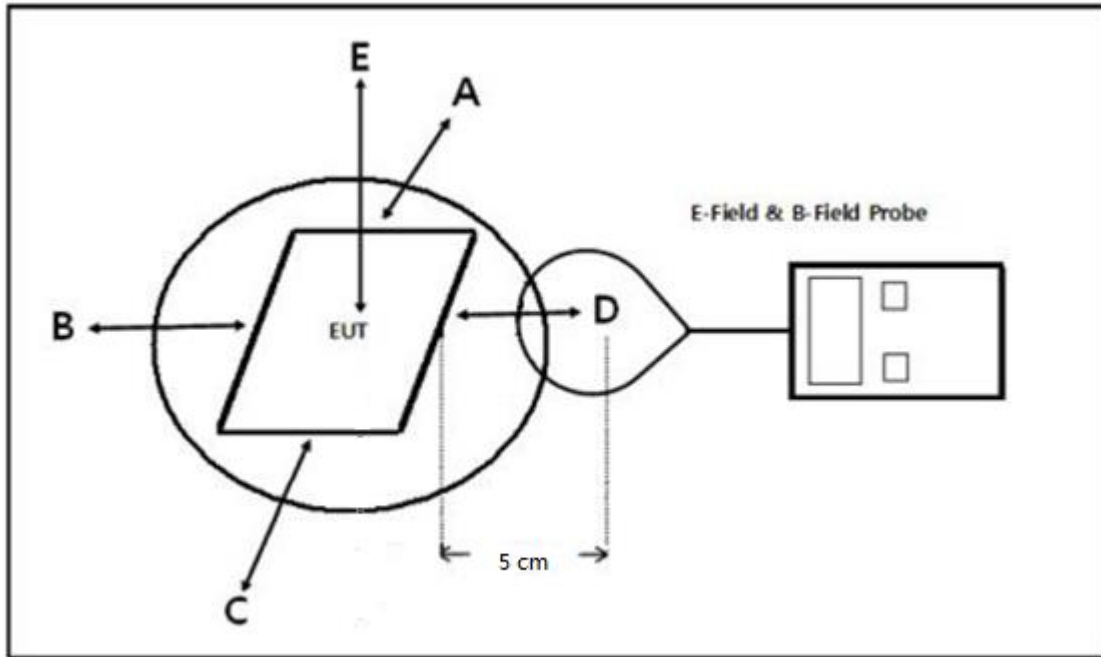

Note: Position A: Front of EUT; Position B: Left of EUT; Position C: back of EUT; Position D: Right of EUT; Position E: Top of EUT

Based on the above standard limit, any device with output power below 5A/m cannot produce an exposure exceeding this restriction under the most pessimistic exposure conditions.

Any report having not been signed by authorized approver, or having been altered without authorization, or having not been stamped by the "Dedicated Testing/Inspection Stamp" is deemed to be invalid. Copying or excerpting portion of, or altering the content of the report is not permitted without the written authorization of AGC. The test results presented in the report apply only to the tested sample. Any objections to report issued by AGC should be submitted to AGC within 15days after the issuance of the test report. Further enquiry of validity or verification of the test report should be addressed to AGC by agc01@agccert.com.

4. TEST EQUIPMENT LIST

Description	Manufacturer	Model	S/N	Cal. Date	Cal. Due
Broadband Field Meter	Narda Safety Test Solutions GmbH	ELT-400	J-0004	Jun. 09, 2021	Jun. 08, 2022
Probe FHP	Narda Safety Test Solutions GmbH	2300/90.10	J-0015	Jun. 09, 2021	Jun. 08, 2022

5. EUT OPERATION CONDITION

NO.	TEST MODE DESCRIPTION
1	Wireless charging Mode(with load 5W)

Any report having not been signed by authorized approver, or having been altered without authorization, or having not been stamped by the "Dedicated Testing/Inspection Stamp" is deemed to be invalid. Copying or excerpting portion of, or altering the content of the report is not permitted without the written authorization of AGC. The test results presented in the report apply only to the tested sample. Any objections to report issued by AGC should be submitted to AGC within 15days after the issuance of the test report. Further enquiry of validity or verification of the test report should be addressed to AGC by agc01@agccert.com.

6. TEST RESULT

Frequency	Maximum Radiated H-Field at 5cm		Limit	Result
MHz	A/m		A/m	Pass/Fail
110kHz-205kHz	position E	0.041	5	Pass
	position A	0.017		
	position B	0.015		
	position C	0.022		
	position D	0.019		

Since Radiated H-Field at worse case is 0.041A/m which cannot exceed the exempt condition, 5A/m. It is deemed to full fit the requirement of RF exposure basic restrisction specified in EC Council Recommendation (1999/519/EC).

7. CONCLUSION

Remark: EUT meets the basic requirements in the standard.



Conditions of Issuance of Test Reports

1. All samples and goods are accepted by the Attestation of Global Compliance (Shenzhen) Co., Ltd (the “Company”) solely for testing and reporting in accordance with the following terms and conditions. The company provides its services on the basis that such terms and conditions constitute express agreement between the company and any person, firm or company requesting its services (the “Clients”).
2. Any report issued by Company as a result of this application for testing services (the “Report”) shall be issued in confidence to the Clients and the Report will be strictly treated as such by the Company. It may not be reproduced either in its entirety or in part and it may not be used for advertising or other unauthorized purposes without the written consent of the Company. The Clients to whom the Report is issued may, however, show or send it, or a certified copy thereof prepared by the Company to its customer, supplier or other persons directly concerned. The Company will not, without the consent of the Clients, enter into any discussion or correspondence with any third party concerning the contents of the Report, unless required by the relevant governmental authorities, laws or court orders.
3. The Company shall not be called or be liable to be called to give evidence or testimony on the Report in a court of law without its prior written consent, unless required by the relevant governmental authorities, laws or court orders.
4. In the event of the improper use of the report as determined by the Company, the Company reserves the right to withdraw it, and to adopt any other additional remedies which may be appropriate.
5. Samples submitted for testing are accepted on the understanding that the Report issued cannot form the basis of, or be the instrument for, any legal action against the Company.
6. The Company will not be liable for or accept responsibility for any loss or damage however arising from the use of information contained in any of its Reports or in any communication whatsoever about its said tests or investigations.
7. Clients wishing to use the Report in court proceedings or arbitration shall inform the Company to that effect prior to submitting the sample for testing.
8. The Company is not responsible for recalling the electronic version of the original report when any revision is made to them. The Client assumes the responsibility to providing the revised version to any interested party who uses them.
9. Subject to the variable length of retention time for test data and report stored hereinto as otherwise specifically required by individual accreditation authorities, the Company will only keep the supporting test data and information of the test report for a period of six years. The data and information will be disposed of after the aforementioned retention period has elapsed. Under no circumstances shall we provide any data and information which has been disposed of after retention period. Under no circumstances shall we be liable for damage of any kind, including (but not limited to) compensatory damages, lost profits, lost data, or any form of special, incidental, indirect, consequential or punitive damages of any kind, whether based on breach of contract of warranty, tort (including negligence), product liability or otherwise, even if we are informed in advance of the possibility of such damages.

Any report having not been signed by authorized approver, or having been altered without authorization, or having not been stamped by the “Dedicated Testing/Inspection Stamp” is deemed to be invalid. Copying or excerpting portion of, or altering the content of the report is not permitted without the written authorization of AGC. The test results presented in the report apply only to the tested sample. Any objections to report issued by AGC should be submitted to AGC within 15 days after the issuance of the test report. Further enquiry of validity or verification of the test report should be addressed to AGC by agc01@agccert.com.