

TEST REPORT

Applicant:

Address:

Report on the submitted sample(s) said to be:

Name: Battery

Type/Model: 1260100, 606090, 1260100, 126090, 105568, 955565, 7565121

Manufacturer:

Address:

Date of Receipt: March 04, 2024

Test period: March 04, 2024 to March 8, 2024

Test Request: In accordance with Directive 2006/66/EC and its amendment directives 2013/56/EU**Test Method:** Please refer to following page(s).**Test Result** Please refer to following page(s).**Test Conclusion:** As specified by client, with reference to Directive 2006/66/EC and its amended Directive 2013/56/EU to determine Lead(Pb), Cadmium(Cd), Mercury(Hg) contents in the submitted sample

Teste By:

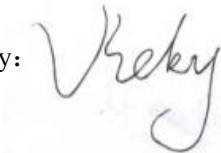

Date: 2022/03/11

Checked By:

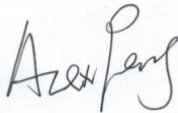

Date: 2022/03/11

Approved By:



Date: 2024/03/8

This test report is responsible for the tested samples only. Without permission of the test center this test report is not permitted to be duplicated in extracts. The test report is invalid without the official stamp of SHENZHEN SIT TESTING TECHNOLOGY CO LTD. The test report is invalid if altered. Objections to the test report must be submitted to SHENZHEN SIT TESTING TECHNOLOGY CO LTD. within 15 days.

SHENZHEN SIT TESTING TECHNOLOGY CO LTD.

Address: Room 401, A2 Building, The 2nd industrial zone of ZhuAo, GuShu Village, XiXiang Town, BaoAn District, ShenZhen

Email: info@sitcert.com Tel: (86)-0755-29173399 Fax: (86)-0755-29179933 Http://www.sit-cert.com

TEST REPORT

Sample description:

Battery

Test method: IEC 62321:2008–Electrotechnical Products - Determination of Levels of Regulated Substances (Lead, Mercury, Cadmium,)

Test Item	Result (mg/kg)	Limit (%)
	1260100	
Lead (Pb)	N.D.	--
Cadmium (Cd)	N.D.	0.002
Mercury (Hg)	N.D.	0.0005

(1) 1 mg/kg = 1 ppm = 0.0001%

(2) N.D. = Not Detected (less than MDL)

(3) MDL = Method Detection Limit

(4) "--" = Not Regulated

(5) Remark: According to the Article 21(3) of Directive 2006/66/EC, Battery, accumulator and button cell shall include the chemical symbol Mercury when containing more than 0.0005% of Hg, the chemical symbol Cadmium when containing more than 0.002% of Cd and the chemical symbol Pb when containing more than 0.004% of Pb

Testing Flow Chart:

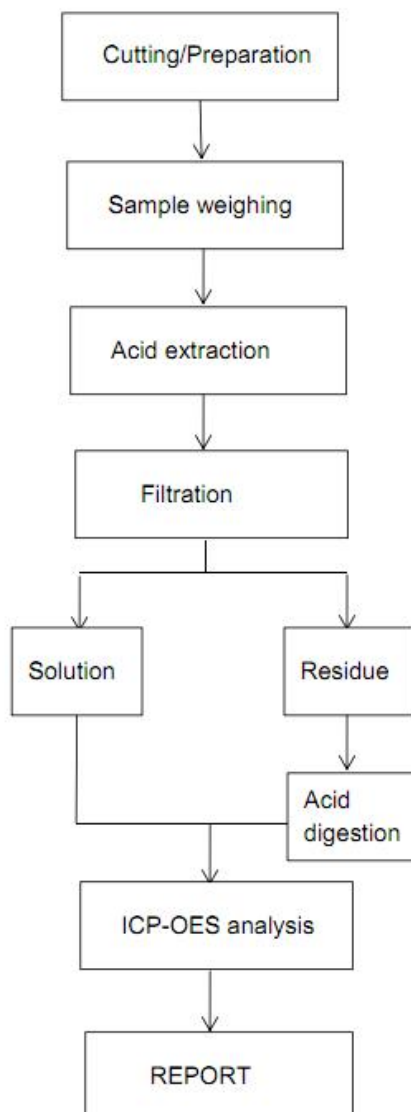

TEST REPORT

Photo of Sample

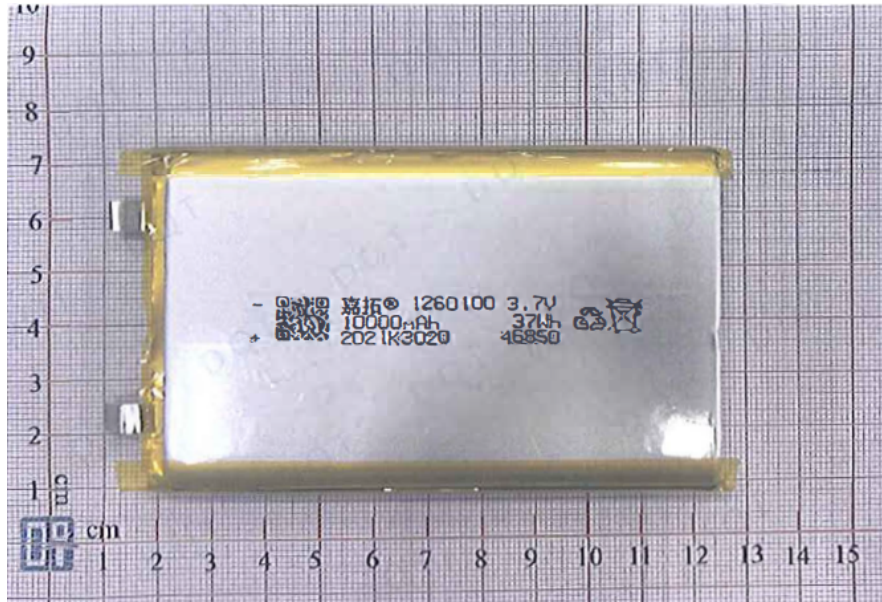

-----End of Report-----



www.lcs-cert.com

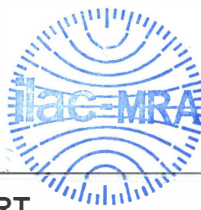

中国认可
国际互认
检测
Version 1.0
CNAS L4595

**TEST REPORT
IEC 62133-2**

Secondary cells and batteries containing alkaline or other non-acid electrolytes – Safety requirements for portable sealed secondary cells, and for batteries made from them, for use in portable applications – Part 2: Lithium systems

Report Number: LCS211011051AS

Date of issue: 2024-03-08

Total number of pages.....: 24 pages

Applicant's name.....:

Address

Test specification:

Standard.....: IEC 62133-2: 2017

Test procedure: Type Test

Non-standard test method.....: N/A

Test Report Form No.....: IEC62133_2A

Test Report Form(s) Originator.....: DEKRA

Master TRF: Dated 2017-08-10

Copyright © 2017 IEC System of Conformity Assessment Schemes for Electro technical Equipment and Components (IECEE System). All rights reserved.

This publication may be reproduced in whole or in part for non-commercial purposes as long as the IECEE is acknowledged as copyright owner and source of the material. IECEE takes no responsibility for and will not assume liability for damages resulting from the reader's interpretation of the reproduced material due to its placement and context.

General disclaimer:

The test results presented in this report relate only to the object tested.
This report shall not be reproduced, except in full, without the written approval of Shenzhen LCS Compliance Testing Laboratory Ltd. The authenticity of this Test Report and its contents can be verified by contacting the Shenzhen LCS Compliance Testing Laboratory Ltd., responsible for this Test Report.

Test item description: Polymer Lithium Ion Cell

Trade Mark: N/A

Manufacturer.....: Same as applicant

Model/Type reference: 1260100

Ratings: 3.7V, 10000mAh, 37Wh



Responsible Testing Laboratory (as applicable), testing procedure and testing location(s):

<input checked="" type="checkbox"/>	Testing Laboratory:	Shenzhen LCS Compliance Testing Laboratory Ltd.	
Testing location/ address		Room 101, 201, Building A and Room 301, Building C, Juji Industrial Park, Yabianxueziwei, Shajing Street, Bao'an District, Shenzhen, Guangdong, China	
Tested by (name, signature).....		City Yu	<i>City Yu</i>
Checked by(name, signature)		Allen Zeng	
Approved by (name, signature)		Hart Qiu	
<input type="checkbox"/>	Testing procedure: CTF Stage 1:		
Testing location/ address			
Tested by (name, function, signature)			
Approved by (name, function, signature) ..			
<input type="checkbox"/>	Testing procedure: CTF Stage 2:		
Testing location/ address			
Tested by (name + signature)			
Witnessed by (name, function, signature) . :			
Approved by (name, function, signature) .. :			
<input type="checkbox"/>	Testing procedure: CTF Stage 3:		
<input type="checkbox"/>	Testing procedure: CTF Stage 4:		
Testing location/ address			
Tested by (name, function, signature)			
Witnessed by (name, function, signature) . :			
Approved by (name, function, signature) .. :			
Supervised by (name, function, signature) :			

TRF No. IEC 62133_2A

Shenzhen LCS Compliance Testing Laboratory Ltd.

Add: Room 101, 201, Building A and Room 301, Building C, Juji Industrial Park, Yabianxueziwei, Shajing Street, Bao'an District, Shenzhen, Guangdong, China

Tel: +(86) 0755-8259 1330 | Fax: +(86) 0755-8259 1332 | E-mail: webmaster@lcs-cert.com | [http:// www.lcs-cert.com](http://www.lcs-cert.com)



List of Attachments (including a total number of pages in each attachment):

Attachment 1: Photo Documentation (1 page).

Summary of testing:

Tests performed (name of test and test clause):

cl.5.6.2 Design recommendation;
 cl.7.1 Charging procedure for test purposes (Cells);
 cl.7.2.1 Continuous charging at constant voltage (Cells);
 cl.7.3.1 External short-circuit (Cells);
 cl.7.3.3 Free fall (Cells);
 cl.7.3.4 Thermal abuse (Cells);
 cl.7.3.5 Crush (Cells);
 cl.7.3.7 Forced discharge (Cells).
 cl.7.3.9 Design evaluation – Forced internal short-circuit (Cells).

The electrolyte type of this cell doesn't belong to polymer, and the additional test cl.7.3.9 was carried out to evaluate the cell.

Tests are made with the number of cells and batteries specified in IEC 62133-2: 2017.

Testing location:

Shenzhen LCS Compliance Testing Laboratory Ltd.
 Room 101, 201, Building A and Room 301, Building C, Juji Industrial Park, Yabianxueziwei, Shajing Street, Bao'an District, Shenzhen, Guangdong, China

Summary of compliance with National Differences (List of countries addressed):

N/A

The product fulfils the requirements of EN62133-2: 2017



Copy of marking plate:

The artwork below may be only a draft. The use of certification marks on a product must be authorized by the respective NCBs that own these marks.

Polymer Lithium Ion Cell	
(+) Model: 1260100	
3.7V, 10000mAh, 37Wh	
(-) INP12/60/111	YYYY/MM/DD

Remark:

“YYYY” means year for manufacture;

“MM” means month for manufacture;

“DD” means day for manufacture.



Test item particulars :	
Classification of installation and use :	To be defined in final product
Supply Connection :	Electrode tab
Recommend charging method declared by the manufacturer..... :	Charging the cell with 2000mA constant current and 4.2V constant voltage until the current reduces to 100mA at ambient 20°C±5°C
Discharge current (0,2 It A)..... :	2000mA
Specified final voltage :	3.0V
Upper limit charging voltage per cell :	4.2V
Maximum charging current..... :	5000mA
Charging temperature upper limit..... :	45°C
Charging temperature lower limit :	10°C
Polymer cell electrolyte type :	<input type="checkbox"/> gel polymer <input type="checkbox"/> solid polymer <input checked="" type="checkbox"/> N/A
Possible test case verdicts:	
- test case does not apply to the test object	N/A
- test object does meet the requirement	P (Pass)
- test object does not meet the requirement	F (Fail)
Testing :	
Date of receipt of test item..... :	2024-03-04
Date (s) of performance of tests :	2024-03-04 to 2024-03-08
General remarks:	
<p>The test results presented in this report relate only to the object tested. This report shall not be reproduced, except in full, without the written approval of the Issuing testing laboratory. "(See Enclosure #)" refers to additional information appended to the report. "(See appended table)" refers to a table appended to the report.</p> <p>Throughout this report a <input type="checkbox"/> comma / <input checked="" type="checkbox"/> point is used as the decimal separator.</p>	
Manufacturer's Declaration per sub-clause 4.2.5 of IEC60080-02:	
The application for obtaining a CB Test Certificate includes more than one factory location and a declaration from the Manufacturer stating that the sample(s) submitted for evaluation is (are) representative of the products from each factory has been provided..... :	<input type="checkbox"/> Yes <input checked="" type="checkbox"/> Not applicable
When differences exist; they shall be identified in the General product information section.	
Name and address of factory (ies) :	Same as applicant.



General product information and other remarks:

The cell consists of the positive electrode plate, negative electrode plate, separator, electrolyte, case. The positive and negative electrode plates are housed in the case in the state being separated by the separator.

The main features of the cell are shown as below (clause 7.1.1):

Model	Nominal capacity	Nominal voltage	Nominal Charge Current	Nominal Discharge Current	Maximum Charge Current	Maximum Discharge Current	Maximum Charge Voltage	Cut-off Voltage
1260100	10000mAh	3.7V	2000mA	2000mA	5000mA	5000mA	4.2V	3.0V

The main features of the cell are shown as below (clause 7.1.2):

Model	Upper limit charge voltage	Taper-off current	Lower charge temperature	Upper charge temperature
1260100	4.2V	500mA	10°C	45°C

Construction:

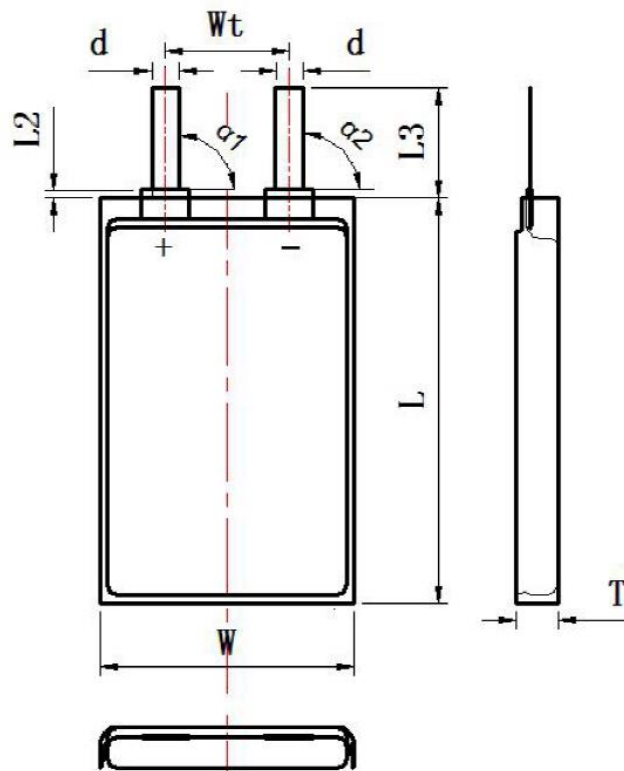

T*W*L(Max)= 12.0*60.0*110.5
Cell (Unit: mm)

Circuit diagram:

None, Cell only.

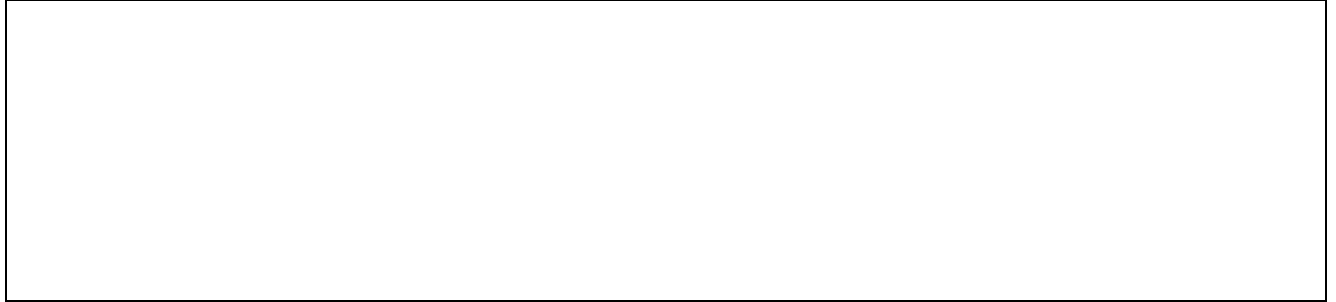

TRF No. IEC 62133_2A

Shenzhen LCS Compliance Testing Laboratory Ltd.

Add: Room 101, 201, Building A and Room 301, Building C, Juji Industrial Park, Yabianxueziwei, Shajing Street, Bao'an District, Shenzhen, Guangdong, China

Tel: +(86) 0755-8259 1330 | Fax: +(86) 0755-8259 1332 | E-mail: webmaster@lcs-cert.com | [http:// www.lcs-cert.com](http://www.lcs-cert.com)



IEC 62133-2: 2017			
Clause	Requirement + Test	Result - Remark	Verdict
4	PARAMETER MEASUREMENT TOLERANCES		P
	Parameter measurement tolerances		P
5	GENERAL SAFETY CONSIDERATIONS		P
5.1	General		P
	Cells and batteries so designed and constructed that they are safe under conditions of both intended use and reasonably foreseeable misuse		P
5.2	Insulation and wiring		P
	The insulation resistance between the positive terminal and externally exposed metal surfaces of the battery (excluding electrical contact surfaces) is not less than 5 MΩ	No metal case exists.	N/A
	Insulation resistance (MΩ).....:		—
	Internal wiring and insulation are sufficient to withstand maximum anticipated current, voltage and temperature requirements		P
	Orientation of wiring maintains adequate clearance and creep age distances between conductors		P
	Mechanical integrity of internal connections accommodates reasonably foreseeable misuse		P
5.3	Venting		P
	Battery cases and cells incorporate a pressure relief mechanism or are constructed so that they relieve excessive internal pressure at a value and rate that will preclude rupture, explosion and self-ignition	Venting mechanism exists on the narrow side of the cell.	P
	Encapsulation used to support cells within an outer casing does not cause the battery to overheat during normal operation nor inhibit pressure relief		N/A
5.4	Temperature, voltage and current management	Cell only.	N/A
	Batteries are designed such that abnormal temperature rise conditions are prevented		N/A
	Batteries are designed to be within temperature, voltage and current limits specified by the cell manufacturer		N/A
	Batteries are provided with specifications and charging instructions for equipment manufacturers so that specified chargers are designed to maintain charging within the temperature, voltage and current limits specified		N/A
5.5	Terminal contacts		P

TRF No. IEC 62133_2A

Shenzhen LCS Compliance Testing Laboratory Ltd.

Add: Room 101, 201, Building A and Room 301, Building C, Juji Industrial Park, Yabianxueziwei, Shajing Street, Bao'an District, Shenzhen, Guangdong, China

Tel: +(86) 0755-8259 1330 | Fax: +(86) 0755-8259 1332 | E-mail: webmaster@lcs-cert.com | http:// www.lcs-cert.com



IEC 62133-2: 2017			
Clause	Requirement + Test	Result - Remark	Verdict
	The size and shape of the terminal contacts ensure that they can carry the maximum anticipated current	Electrode tab complied with the requirements.	P
	External terminal contact surfaces are formed from conductive materials with good mechanical strength and corrosion resistance		P
	Terminal contacts are arranged to minimize the risk of short-circuit		N/A
5.6	Assembly of cells into batteries	Cell only.	N/A
5.6.1	General		N/A
	Each battery have an independent control and protection for current, voltage, temperature and any other parameter required for safety and to maintain the cells within their operating region		N/A
	This protection may be provided external to the battery such as within the charger or the end devices		N/A
	If protection is external to the battery, the manufacturer of the battery provide this safety relevant information to the external device manufacturer for implementation		N/A
	If there is more than one battery housed in a single battery case, each battery have protective circuitry that can maintain the cells within their operating regions		N/A
	Manufacturers of cells specify current, voltage and temperature limits so that the battery manufacturer/designer may ensure proper design and assembly		N/A
	Batteries that are designed for the selective discharge of a portion of their series connected cells incorporate circuitry to prevent operation of cells outside the limits specified by the cell manufacturer		N/A
	Protective circuit components added as appropriate and consideration given to the end-device application		N/A
	The manufacturer of the battery provide a safety analysis of the battery safety circuitry with a test report including a fault analysis of the protection circuit under both charging and discharging conditions confirming the compliance		N/A
5.6.2	Design recommendation	Cell only.	N/A
	For the battery consisting of a single cell or a single cellblock, it is recommended that the charging voltage of the cell does not exceed the upper limit of the charging voltage specified in Table 2		N/A

TRF No. IEC 62133_2A

Shenzhen LCS Compliance Testing Laboratory Ltd.

Add: Room 101, 201, Building A and Room 301, Building C, Juji Industrial Park, Yabianxueziwei, Shajing Street, Bao'an District, Shenzhen, Guangdong, China

Tel: +(86) 0755-8259 1330 | Fax: +(86) 0755-8259 1332 | E-mail: webmaster@lcs-cert.com | http:// www.lcs-cert.com



IEC 62133-2: 2017			
Clause	Requirement + Test	Result - Remark	Verdict
	For the battery consisting of series-connected plural single cells or series-connected plural cellblocks, it is recommended that the voltages of any one of the single cells or single cellblocks does not exceed the upper limit of the charging voltage, specified in Table 2, by monitoring the voltage of every single cell or the single cellblocks		N/A
	For the battery consisting of series-connected plural single cells or series-connected plural cellblocks, it is recommended that charging is stopped when the upper limit of the charging voltage is exceeded for any one of the single cells or single cellblocks by measuring the voltage of every single cell or the single cellblocks		N/A
	For batteries consisting of series-connected cells or cell blocks, nominal charge voltage not be counted as an overcharge protection		N/A
	For batteries consisting of series-connected cells or cell blocks, cells have closely matched capacities, be of the same design, be of the same chemistry and be from the same manufacturer		N/A
	It is recommended that the cells and cell blocks not discharged beyond the cell manufacturer's specified final voltage		N/A
	For batteries consisting of series-connected cells or cell blocks, cell balancing circuitry incorporated into the battery management system		N/A
5.6.3	Mechanical protection for cells and components of batteries	Cell only.	N/A
	Mechanical protection for cells, cell connections and control circuits within the battery provided to prevent damage as a result of intended use and reasonably foreseeable misuse		N/A
	The mechanical protection can be provided by the battery case or it can be provided by the end product enclosure for those batteries intended for building into an end product		N/A
	The battery case and compartments housing cells designed to accommodate cell dimensional tolerances during charging and discharging as recommended by the cell manufacturer		N/A
	For batteries intended for building into a portable end product, testing with the battery installed within the end product considered when conducting mechanical tests		N/A
5.7	Quality plan		P

TRF No. IEC 62133_2A

Shenzhen LCS Compliance Testing Laboratory Ltd.

Add: Room 101, 201, Building A and Room 301, Building C, Juji Industrial Park, Yabianxueziwei, Shajing Street, Bao'an District, Shenzhen, Guangdong, China

Tel: +(86) 0755-8259 1330 | Fax: +(86) 0755-8259 1332 | E-mail: webmaster@lcs-cert.com | http:// www.lcs-cert.com



IEC 62133-2: 2017			
Clause	Requirement + Test	Result - Remark	Verdict
	The manufacturer prepares and implements a quality plan that defines procedures for the inspection of materials, components, cells and batteries and which covers the whole process of producing each type of cell or battery	Complied. Quality plan provided.	P
5.8	Battery safety components		P
	According annex F	See TABLE: Critical components information	N/A
6	TYPE TEST AND SAMPLE SIZE		P
	Tests are made with the number of cells or batteries specified in Table 1 using cells or batteries that are not more than six months old		P
	Coin cells with resistance $\leq 3 \Omega$ (measured according annex D) are tested according table 1	Not coin cells	N/A
	Unless otherwise specified, tests are carried out in an ambient temperature of $20 \text{ }^\circ\text{C} \pm 5 \text{ }^\circ\text{C}$		P
	The safety analysis of 5.6.1 identify those components of the protection circuit that are critical for short-circuit, overcharge and over discharge protection	Cell only.	N/A
	When conducting the short-circuit test, consideration given to the simulation of any single fault condition that is likely to occur in the protecting circuit that would affect the short-circuit test	Cell only.	N/A
7	SPECIFIC REQUIREMENTS AND TESTS		P
7.1	Charging procedure for test purposes		P
7.1.1	First procedure		P
	This charging procedure applies to sub clauses other than those specified in 7.1.2		P
	Unless otherwise stated in this document, the charging procedure for test purposes is carried out in an ambient temperature of $20 \text{ }^\circ\text{C} \pm 5 \text{ }^\circ\text{C}$, using the method declared by the manufacturer	See page 5	P
	Prior to charging, the battery have been discharged at $20 \text{ }^\circ\text{C} \pm 5 \text{ }^\circ\text{C}$ at a constant current of 0,2 It A down to a specified final voltage	See page 5	P
7.1.2	Second procedure		P
	This charging procedure applies only to 7.3.1, 7.3.4, 7.3.5, and 7.3.9		P

TRF No. IEC 62133_2A

Shenzhen LCS Compliance Testing Laboratory Ltd.

Add: Room 101, 201, Building A and Room 301, Building C, Juji Industrial Park, Yabianxueziwei, Shajing Street, Bao'an District, Shenzhen, Guangdong, China

Tel: +(86) 0755-8259 1330 | Fax: +(86) 0755-8259 1332 | E-mail: webmaster@lcs-cert.com | http:// www.lcs-cert.com



IEC 62133-2: 2017			
Clause	Requirement + Test	Result - Remark	Verdict
	After stabilization for 1 h and 4 h, respectively, at ambient temperature of highest test temperature and lowest test temperature, as specified in Table 2, cells are charged by using the upper limit charging voltage and maximum charging current, until the charging current is reduced to 0,05 It A, using a constant voltage charging method.	Charge temperature 10-45°C declared. 45°C used for upper limit tests; 10°C used for lower limit tests.	N/A
7.2	Intended use		P
7.2.1	Continuous charging at constant voltage (cells)	Tested complied.	P
	Fully charged cells are subjected for 7 days to a charge using the charging method for current and standard voltage specified by the cell manufacturer	Charging for 7 days with 2000mA	P
	Results: No fire. No explosion. No leakage :	(See appended table 7.2.1)	P
7.2.2	Case stress at high ambient temperature (battery)	Cell only.	N/A
	Oven temperature (°C)..... :		—
	Results: No physical distortion of the battery case resulting in exposure of internal protective components and cells		N/A
7.3	Reasonably foreseeable misuse		P
7.3.1	External short-circuit (cell)	Tested complied.	P
	The cells were tested until one of the following occurred:		P
	- 24 hours elapsed; or		N/A
	- The case temperature declined by 20% of the maximum temperature rise		P
	Results: No fire. No explosion :	(See appended table 7.3.1)	P
7.3.2	External short-circuit (battery)	Cell only.	N/A
	The batteries were tested until one of the following occurred:		N/A
	- 24 hours elapsed; or		N/A
	- The case temperature declined by 20 % of the maximum temperature rise		N/A
	In case of rapid decline in short circuit current, the battery pack remained on test for an additional one hour after the current reached a low end steady state condition		N/A
	A single fault in the discharge protection circuit conducted on one to four (depending upon the protection circuit) of the five samples before conducting the short-circuit test		N/A
	A single fault applies to protective component parts such as MOSFET, fuse, thermostat or positive temperature coefficient (PTC) thermistor		N/A
	Results: No fire. No explosion :		N/A

TRF No. IEC 62133_2A

Shenzhen LCS Compliance Testing Laboratory Ltd.

Add: Room 101, 201, Building A and Room 301, Building C, Juji Industrial Park, Yabianxueziwei, Shajing Street, Bao'an District, Shenzhen, Guangdong, China

Tel: +(86) 0755-8259 1330 | Fax: +(86) 0755-8259 1332 | E-mail: webmaster@lcs-cert.com | http:// www.lcs-cert.com



IEC 62133-2: 2017			
Clause	Requirement + Test	Result - Remark	Verdict
7.3.3	Free fall	Tested complied.	P
	Results: No fire. No explosion	No fire. No explosion.	P
7.3.4	Thermal abuse (cells)	Tested complied.	P
	Oven temperature (°C)..... :	130°C	—
	Results: No fire. No explosion	No fire. No explosion	P
7.3.5	Crush (cells)	Tested complied.	P
	The crushing force was released upon:		P
	- The maximum force of 13 kN±0,78kN has been applied; or		P
	- An abrupt voltage drop of one-third of the original voltage has been obtained		N/A
	Results: No fire. No explosion	(See appended table 7.3.5)	P
7.3.6	Over-charging of battery	Cell only.	N/A
	The supply voltage which is:		--
	- 1,4 times the upper limit charging voltage presented in Table A.1 (but not to exceed 6,0 V) for single cell/cell block batteries or		N/A
	- 1,2 times the upper limit charging voltage resented in Table A.1 per cell for series connected multi-cell batteries, and		N/A
	- Sufficient to maintain a current of 2,0 It A throughout the duration of the test or until the supply voltage is reached		N/A
	Test was continued until the temperature of the outer casing:		N/A
	- Reached steady state conditions (less than 10°C change in 30-minute period); or		N/A
	- Returned to ambient		N/A
	Results: No fire. No explosion		N/A
7.3.7	Forced discharge (cells)	Tested complied.	P
	If the discharge voltage reaches the negative value of upper limit charging voltage within the testing duration, the voltage is maintained at the negative value of the upper limit charging voltage by reducing the current for the remainder of the testing duration		N/A
	If the discharge voltage does not reach the negative value of upper limit charging voltage within the testing duration, the test is terminated at the end of the testing duration		P
	Results: No fire. No explosion	(See appended table 7.3.7)	P

TRF No. IEC 62133_2A

Shenzhen LCS Compliance Testing Laboratory Ltd.

Add: Room 101, 201, Building A and Room 301, Building C, Juji Industrial Park, Yabianxueziwei, Shajing Street, Bao'an District, Shenzhen, Guangdong, China

Tel: +(86) 0755-8259 1330 | Fax: +(86) 0755-8259 1332 | E-mail: webmaster@lcs-cert.com | http:// www.lcs-cert.com



IEC 62133-2: 2017			
Clause	Requirement + Test	Result - Remark	Verdict
7.3.8	Mechanical tests (batteries)	Cell only.	N/A
7.3.8.1	Vibration		N/A
	Results: No fire, no explosion, no rupture, no leakage or venting.:		N/A
7.3.8.2	Mechanical shock		N/A
	Results: No leakage, no venting, no rupture, no explosion and no fire		N/A
7.3.9	Design evaluation – Forced internal short-circuit (cells)	Tested complied.	P
	The cells complied with national requirement for..... :	France, Japan, Republic of Korea, Switzerland	—
	The pressing was stopped upon:		P
	- A voltage drop of 50 mV has been detected; or		N/A
	- The pressing force of 800 N (cylindrical cells) or 400 N (prismatic cells) has been reached	400N for prismatic cells	P
	Results: No fire	(See appended table 7.3.9)	P
8	INFORMATION FOR SAFETY		P
8.1	General		P
	Manufacturers of secondary cells ensure that information is provided about current, voltage and temperature limits of their products	Information for safety mentioned in manufacturer's specifications.	P
	Manufacturers of batteries ensure that equipment manufacturers and, in the case of direct sales, end-users are provided with information to minimize and mitigate hazards	Cell only.	N/A
	Systems analyses performed by device manufacturers to ensure that a particular battery design prevents hazards from occurring during use of a product		N/A
	As appropriate, any information relating to hazard avoidance resulting from a system analysis provided to the end user		N/A
	Do not allow children to replace batteries without adult supervision		N/A
8.2	Small cell and battery safety information		N/A
	The following warning language is to be provided with the information packaged with the small cells and batteries or equipment using them:		N/A
	- Keep small cells and batteries which are considered swallow able out of the reach of children		N/A

TRF No. IEC 62133_2A

Shenzhen LCS Compliance Testing Laboratory Ltd.

Add: Room 101, 201, Building A and Room 301, Building C, Juji Industrial Park, Yabianxueziwei, Shajing Street, Bao'an District, Shenzhen, Guangdong, China

Tel: +(86) 0755-8259 1330 | Fax: +(86) 0755-8259 1332 | E-mail: webmaster@lcs-cert.com | http:// www.lcs-cert.com



IEC 62133-2: 2017			
Clause	Requirement + Test	Result - Remark	Verdict
	- Swallowing may lead to burns, perforation of soft tissue, and death. Severe burns can occur within 2 h of ingestion		N/A
	- In case of ingestion of a cell or battery, seek medical assistance promptly		N/A
9	MARKING		P
9.1	Cell marking		P
	Cells marked as specified in IEC 61960, except coin cells	The cell is marked in accordance with IEC 61960, also see page 4.	P
	Coin cells whose external surface area is too small to accommodate the markings on the cells show the designation and polarity		N/A
	By agreement between the cell manufacturer and the battery and/or end product manufacturer, component cells used in the manufacture of a battery need not be marked		N/A
9.2	Battery marking	Cell only.	N/A
	Batteries marked as specified in IEC 61960, except for coin batteries		N/A
	Coin batteries whose external surface area is too small to accommodate the markings on the batteries show the designation and polarity. Batteries also marked with an appropriate caution statement		N/A
	Terminals have clear polarity marking on the external surface of the battery		N/A
	Batteries with keyed external connectors designed for connection to specific end products need not be marked with polarity markings if the design of the external connector prevents reverse polarity connections		N/A
9.3	Caution for ingestion of small cells and batteries	Not small cell and battery	N/A
	Coin cells and batteries identified as small batteries according to 8.2 include a caution statement regarding the hazards of ingestion in accordance with 8.2		N/A
	When small cells and batteries are intended for direct sale in consumer-replaceable applications, caution for ingestion given on the immediate package		N/A
9.4	Other information		P
	Storage and disposal instructions	Information for safety mentioned in manufacturer's specifications.	P

TRF No. IEC 62133_2A

Shenzhen LCS Compliance Testing Laboratory Ltd.

Add: Room 101, 201, Building A and Room 301, Building C, Juji Industrial Park, Yabianxueziwei, Shajing Street, Bao'an District, Shenzhen, Guangdong, China

Tel: +(86) 0755-8259 1330 | Fax: +(86) 0755-8259 1332 | E-mail: webmaster@lcs-cert.com | http://www.lcs-cert.com



IEC 62133-2: 2017			
Clause	Requirement + Test	Result - Remark	Verdict
	Recommended charging instructions	Information for safety mentioned in manufacturer's specifications.	P

10	PACKAGING AND TRANSPORT		P
	Packaging for coin cells not small enough to fit within the limits of the ingestion gauge of Figure 3	Not coin cells	N/A
	The materials and packaging design are chosen so as to prevent the development of unintentional electrical conduction, corrosion of the terminals and ingress of environmental contaminants		P

ANNEX A	CHARGING AND DISCHARGING RANGE OF SECONDARY LITHIUM ION CELLS FOR SAFE USE		P
A.1	General		P
A.2	Safety of lithium ion secondary battery	Complied.	P
A.3	Consideration on charging voltage	Complied.	P
A.3.1	General		P
A.3.2	Upper limit charging voltage	4.2V	P
A.3.2.1	General		P
A.3.2.2	Explanation of safety viewpoint		N/A
A.3.2.3	Safety requirements, when different upper limit charging voltage is applied	4.2V applied.	N/A
A.4	Consideration of temperature and charging current		P
A.4.1	General		P
A.4.2	Recommended temperature range	See A.4.2.2.	P
A.4.2.1	General		P
A.4.2.2	Safety consideration when a different recommended temperature range is applied	Charging temperature declared by client is: 10~45°C	N/A
A.4.3	High temperature range	Not higher than the temperature range specific in this standard.	N/A
A.4.3.1	General		N/A
A.4.3.2	Explanation of safety viewpoint		N/A
A.4.3.3	Safety considerations when specifying charging conditions in the high temperature range		N/A
A.4.3.4	Safety considerations when specifying a new upper limit in the high temperature range		N/A

TRF No. IEC 62133_2A

Shenzhen LCS Compliance Testing Laboratory Ltd.

Add: Room 101, 201, Building A and Room 301, Building C, Juji Industrial Park, Yabianxueziwei, Shajing Street, Bao'an District, Shenzhen, Guangdong, China

Tel: +(86) 0755-8259 1330 | Fax: +(86) 0755-8259 1332 | E-mail: webmaster@lcs-cert.com | http://www.lcs-cert.com



IEC 62133-2: 2017			
Clause	Requirement + Test	Result - Remark	Verdict
A.4.4	Low temperature range	Not lower than the temperature range specific in this standard.	N/A
A.4.4.1	General		N/A
A.4.4.2	Explanation of safety viewpoint		N/A
A.4.4.3	Safety considerations, when specifying charging conditions in the low temperature range		N/A
A.4.4.4	Safety considerations when specifying a new lower limit in the low temperature range		N/A
A.4.5	Scope of the application of charging current		P
A.4.6	Consideration of discharge		P
A.4.6.1	General		P
A.4.6.2	Final discharge voltage and explanation of safety viewpoint		P
A.4.6.3	Discharge current and temperature range		P
A.4.6.4	Scope of application of the discharging current		P
A.5	Sample preparation		P
A.5.1	General		P
A.5.2	Insertion procedure for nickel particle to generate internal short		P
A.5.3	Disassembly of charged cell		P
A.5.4	Shape of nickel particle		P
A.5.5	Insertion of nickel particle in cylindrical cell		N/A
A.5.5.1	Insertion of nickel particle in winding core		N/A
A.5.5.2	Marking the position of the nickel particle on both ends of the winding core of the separator		N/A
A.5.6	Insertion of nickel particle in prismatic cell		P
A.6	Experimental procedure of the forced internal short-circuit test		P
A.6.1	Material and tools for preparation of nickel particle		P
A.6.2	Example of a nickel particle preparation procedure		P
A.6.3	Positioning (or placement) of a nickel particle		P
A.6.4	Damaged separator precaution		P
A.6.5	Caution for rewinding separator and electrode		P
A.6.6	Insulation film for preventing short-circuit		P
A.6.7	Caution when disassembling a cell		P
A.6.8	Protective equipment for safety		P

TRF No. IEC 62133_2A

Shenzhen LCS Compliance Testing Laboratory Ltd.

Add: Room 101, 201, Building A and Room 301, Building C, Juji Industrial Park, Yabianxueziwei, Shajing Street, Bao'an District, Shenzhen, Guangdong, China

Tel: +(86) 0755-8259 1330 | Fax: +(86) 0755-8259 1332 | E-mail: webmaster@lcs-cert.com | http:// www.lcs-cert.com



IEC 62133-2: 2017			
Clause	Requirement + Test	Result - Remark	Verdict
A.6.9	Caution in the case of fire during disassembling		P
A.6.10	Caution for the disassembling process and pressing the electrode core		P
A.6.11	Recommended specifications for the pressing device		P
ANNEX B	RECOMMENDATIONS TO EQUIPMENT MANUFACTURERS AND BATTERY ASSEMBLERS		N/A
ANNEX C	RECOMMENDATIONS TO THE END-USERS		N/A
ANNEX D	MEASUREMENT OF THE INTERNAL AC RESISTANCE FOR COIN CELLS		N/A
D.1	General	Not coin cells	N/A
D.2	Method		N/A
	A sample size of three coin cells is required for this measurement	(See appended tableD.2)	N/A
	Coin cells with an internal resistance of less than or equal to 3 Ω are subjected to the testing according to Clause 6 and Table 1		N/A
	Coin cells with an internal resistance greater than 3 Ω require no further testing		N/A
ANNEX E	PACKAGING AND TRANSPORT		N/A
ANNEX F	COMPONENT STANDARDS REFERENCES		N/A

TRF No. IEC 62133_2A

Shenzhen LCS Compliance Testing Laboratory Ltd.

Add: Room 101, 201, Building A and Room 301, Building C, Juji Industrial Park, Yabianxueziwei, Shajing Street, Bao'an District, Shenzhen, Guangdong, China

Tel: +(86) 0755-8259 1330 | Fax: +(86) 0755-8259 1332 | E-mail: webmaster@lcs-cert.com | http:// www.lcs-cert.com



TABLE: Critical components information					P
Object/part no.	Manufacturer/ trademark	Type/model	Technical data	Standard	Mark(s) of conformity ¹⁾
Cell		1260100	3.7V,10000mAh	IEC 62133-2: 2017	Tested with appliance
- Electrolyte	Shantou Golden Light Technology Co., LTD	E93D	LiPF ₆ +EMC+EC+DEC	--	--
- Separator	Shenzhen YuTu Technology Co., Ltd	PE	15μm, Shutdown temperature: 135°C	--	--
- Positive Electrode	Jiangmen Kanhoo Industry Co., Ltd.	N85G	Li(Ni _{0.5} Co _{0.2} Mn _{0.3})O ₂ , Carbon Black, NMP, PVDF, Conductive Additive	--	--
- Negative Electrode	Jiangxi Zichen Technology Co., LTD	B98309	Graphite, CMC, SBR, Distilled Water, Conductive Additive	--	--
Supplementary information:					
¹⁾ Provided evidence ensures the agreed level of compliance.					

TRF No. IEC 62133_2A

Shenzhen LCS Compliance Testing Laboratory Ltd.

Add: Room 101, 201, Building A and Room 301, Building C, Juji Industrial Park, Yabianxueziwei, Shajing Street, Bao'an District, Shenzhen, Guangdong, China

Tel: +(86) 0755-8259 1330 | Fax: +(86) 0755-8259 1332 | E-mail: webmaster@lcs-cert.com | http:// www.lcs-cert.com



7.2.1	TABLE: Continuous charging at constant voltage (cells)				P
Sample no.	Recommended charging voltage Vc (Vdc)	Recommended charging current I _{rec} (mA)	OCV before test (Vdc)	Results	
Cell #1	4.20	2000	4.19	P	
Cell #2	4.20	2000	4.19	P	
Cell #3	4.20	2000	4.18	P	
Cell #4	4.20	2000	4.18	P	
Cell #5	4.20	2000	4.18	P	
Supplementary information:					
- No fire or explosion					
- No leakage					

7.3.1	TABLE: External short-circuit (cell)					P
Sample no.	Ambient T (°C)	OCV before test (Vdc)	Resistance of circuit (mΩ)	Maximum case temperature rise ΔT, (°C)	Results	
Samples charged at charging temperature upper limit (45°C)						
Cell #6	55.7	4.17	83	119.9	P	
Cell #7	55.7	4.17	86	111.3	P	
Cell #8	55.7	4.16	84	118.0	P	
Cell #9	55.7	4.16	79	116.7	P	
Cell #10	55.7	4.17	87	112.7	P	
Samples charged at charging temperature lower limit (10°C)						
Cell #11	55.5	4.11	85	104.2	P	
Cell #12	55.5	4.12	81	101.7	P	
Cell #13	55.5	4.11	82	108.8	P	
Cell #14	55.5	4.12	81	103.4	P	
Cell #15	55.5	4.11	84	107.4	P	
Supplementary information:						
- No fire or explosion						

TRF No. IEC 62133_2A

Shenzhen LCS Compliance Testing Laboratory Ltd.

Add: Room 101, 201, Building A and Room 301, Building C, Juji Industrial Park, Yabianxueziwei, Shajing Street, Bao'an District, Shenzhen, Guangdong, China

Tel: +(86) 0755-8259 1330 | Fax: +(86) 0755-8259 1332 | E-mail: webmaster@lcs-cert.com | http:// www.lcs-cert.com



7.3.2	TABLE: External short-circuit (battery)					N/A
Sample no.	Ambient(°C)	OCV before test (Vdc)	Resistance of circuit (mΩ)	Maximum case temperature rise ΔT , (°C)	Component single fault condition	Results
Supplementary information:						
- No fire or explosion						

7.3.5	TABLE: Crush (cells)				P
Sample no.	OCV before test (Vdc)	OCV at removal of crushing force (Vdc)	Maximum force applied to the cell during crush (kN)	Results	
Samples charged at charging temperature upper limit (45°C)					
Cell #29	4.17	4.17	13	P	
Cell #30	4.17	4.17	13	P	
Cell #31	4.16	4.16	13	P	
Cell #32	4.16	4.16	13	P	
Cell #33	4.16	4.16	13	P	
Samples charged at charging temperature lower limit (10°C)					
Cell #34	4.12	4.12	13	P	
Cell #35	4.12	4.12	13	P	
Cell #36	4.11	4.11	13	P	
Cell #37	4.11	4.10	13	P	
Cell #38	4.11	4.11	13	P	
Supplementary information:					
- No fire or explosion					

TRF No. IEC 62133_2A

Shenzhen LCS Compliance Testing Laboratory Ltd.

Add: Room 101, 201, Building A and Room 301, Building C, Juji Industrial Park, Yabianxueziwei, Shajing Street, Bao'an District, Shenzhen, Guangdong, China

Tel: +(86) 0755-8259 1330 | Fax: +(86) 0755-8259 1332 | E-mail: webmaster@lcs-cert.com | http://www.lcs-cert.com



7.3.6		TABLE: Over-charging of battery			N/A
Constant charging current (A)					—
Supply voltage (Vdc).....					—
Sample no.	OCV before charging (Vdc)	Total charging time (minute)	Maximum outer case temperature (°C)	Results	
Supplementary information:					
- No fire or explosion					

7.3.7		TABLE: Forced discharge (cells)			P
Sample no.	OCV before application of reverse charge (Vdc)	Measured reverse charge I _t (mA)	Lower limit discharge voltage (Vdc)	Results	
Cell #39	3.31	10000	3.0	P	
Cell #40	3.30	10000	3.0	P	
Cell #41	3.29	10000	3.0	P	
Cell #42	3.29	10000	3.0	P	
Cell #43	3.31	10000	3.0	P	
Supplementary information:					
- No fire or explosion					

7.3.8.1		TABLE: Vibration				N/A
Sample no.	OCV before test (Vdc)	OCV after test (Vdc)	Mass before test (g)	Mass after test (g)	Results	
Supplementary information:						
- No fire or explosion						
- No rupture						
- No leakage						
- No venting						

TRF No. IEC 62133_2A

Shenzhen LCS Compliance Testing Laboratory Ltd.

Add: Room 101, 201, Building A and Room 301, Building C, Juji Industrial Park, Yabianxueziwei, Shajing Street, Bao'an District, Shenzhen, Guangdong, China

Tel: +(86) 0755-8259 1330 | Fax: +(86) 0755-8259 1332 | E-mail: webmaster@lcs-cert.com | http:// www.lcs-cert.com



7.3.8.2	TABLE: Mechanical shock					N/A
Sample no.	OCV before test (Vdc)	OCV after test (Vdc)	Mass before test (g)	Mass after test (g)	Results	

Supplementary information:

- No fire or explosion
- No rupture
- No leakage
- No venting

7.3.9	TABLE: Forced internal short circuit (cells)					P
Sample no.	Chamber ambient T (°C)	OCV before test (Vdc)	Particle location ¹⁾	Maximum applied pressure (N)	Results	
Samples charged at charging temperature upper limit (45°C)						
Cell #44	45	4.17	1	400	P	
Cell #45	45	4.16	1	400	P	
Cell #46	45	4.17	1	400	P	
Cell #47	45	4.16	1	400	P	
Cell #48	45	4.16	1	400	P	
Samples charged at charging temperature lower limit (10°C)						
Cell #49	10	4.11	1	400	P	
Cell #50	10	4.12	1	400	P	
Cell #51	10	4.12	1	400	P	
Cell #52	10	4.11	1	400	P	
Cell #53	10	4.11	1	400	P	

Supplementary information:

¹⁾Identify one of the following:

- 1: Nickel particle inserted between positive and negative (active material) coated area.
- 2: Nickel particle inserted between positive aluminium foil and negative active material coated area.

- No fire or explosion



D.2	TABLE: Internal AC resistance for coin cells				N/A
Sample no.	Ambient T (°C)	Store time (h)	Resistance Rac (Ω)	Results ¹⁾	
Supplementary information:					
¹⁾ Coin cells with internal resistance less than or equal to 3 Ω, see test result on corresponding tables					

-- End of Report --

Attachment 1

Photo Documentation



Product: Polymer Lithium Ion Cell

Type Designation: 1260100



Figure 1 Front view of cell



Figure 2 Back view of cell

TRF No. IEC 62133_2A

Shenzhen LCS Compliance Testing Laboratory Ltd.

Add: Room 101, 201, Building A and Room 301, Building C, Juji Industrial Park, Yabianxueziwei, Shajing Street, Bao'an District, Shenzhen, Guangdong, China

Tel: +(86) 0755-8259 1330 | Fax: +(86) 0755-8259 1332 | E-mail: webmaster@lcs-cert.com | <http://www.lcs-cert.com>